

MasterCut

Tool Corp.

The Cutting Edge Mastered



FRACTIONAL PRODUCT CATALOG
ENDMILLS • DRILLS • REAMERS • ROUTERS • BURS



**Please contact us
for our full line of
metric products**



Metric catalog available in the following languages:

Chinese
English
French
German
Italian

Japanese
Korean
Portuguese
Russian
Spanish



About Mastercut

Our History

1985	Incorporated in Safety Harbor, Florida
1986	Form grinding and brazing operations are added
1989	Company builds its first machine for manufacturing burs
1989	First CNC machine is purchased to help with quality and growth
1991	Production of endmills commences
1994	5 and 6 axis CNC machines purchased for volume production of burs, endmills and drills
1995	Laser marking introduced; laser inspection systems implemented
1999	Cell concept introduced in a new facility for greater production and quality control
2002	Production of spiral router bits, drills, and reamers commences
2003	ISO 9001:2000 certification achieved; first coating machine purchased
2004	MAP, Mastercut's Automated Production system developed
2005	CNC1st team (Customers' Needs Come 1st) implemented; second coating machine added
2006	Production begins on high-performance endmills, drills, and miniature tooling
2009	ISO 9001:2008 certification achieved
2011	New surface treatments introduced
2013	Nano coatings and Pro+ performance tools introduced
2015	Mastercut celebrates 30th anniversary, and facility expansion
2016	Warehouse expansions in USA and Europe
2018	ISO 9001:2015 certification achieved
2020	Mastercut celebrates 35 years of quality and innovation

Today

Mastercut Tool Corp. celebrates more than 3 decades as a world class carbide cutting tool manufacturer. From inception to the present, our goal is providing the highest quality products and services to our customers. All products are still manufactured in Florida, using state of the art equipment, skilled craftsmen and our exclusive MAP technology.

Our Thanks to Our Loyal Customers and Associates

Our history would not be possible without the support of all those associated with us. We thank all of our customers and associates, as well as our community, for your dedication and loyalty. We pledge to continuously improve for you!















Please check out the following catalogs and services:

- Metric carbide tooling
- Solid carbide fractional and metric routers
- Capabilities to produce your special tools for all applications
- Authorized reconditioning factory for complete regrind and reconditioning services

TABLE OF CONTENTS

Cermet	Hardened	Cast Iron	Titanium	Non-Ferrous	Stainless	Steel
H	K	S	N	M	P	

STANDARD ENDMILLS (Page 10)

	Square Endmills	12	Cermet	Cast Iron K	Titanium S	Non-Ferrous N	Stainless M	Steel P
	Ball Endmills	15	Cermet	Cast Iron K	Titanium S	Non-Ferrous N	Stainless M	Steel P
	Corner Radius Endmills	18	Cermet	Cast Iron K	Titanium S	Non-Ferrous N	Stainless M	Steel P
	6 Flute Square Endmills	26		Cast Iron K	Titanium S		Stainless M	Steel P
	Square End - Double End Endmills	27	Cermet	Cast Iron K	Titanium S	Non-Ferrous N	Stainless M	Steel P
	Ball End - Double End Endmills	29	Cermet	Cast Iron K	Titanium S	Non-Ferrous N	Stainless M	Steel P
	Square End - Double End Endmills w/ Flat	31	Cermet	Cast Iron K	Titanium S	Non-Ferrous N	Stainless M	Steel P
	Ball End - Double End Endmills w/ Flat	31	Cermet	Cast Iron K	Titanium S	Non-Ferrous N	Stainless M	Steel P
	90° Drill Mills	32	Cermet	Cast Iron K	Titanium S	Non-Ferrous N	Stainless M	Steel P
	Square End, Straight Flute Endmills	33	Hardened H	Cast Iron K				Steel P
	Ball End, Straight Flute Endmills	33	Hardened H	Cast Iron K				Steel P
	Square End Mini Mills	34	Cermet	Cast Iron K	Titanium S	Non-Ferrous N	Stainless M	Steel P
	Ball End Mini Mills	35	Cermet	Cast Iron K	Titanium S	Non-Ferrous N	Stainless M	Steel P
	Square End Taper Mills	36	Cermet	Cast Iron K	Titanium S	Non-Ferrous N	Stainless M	Steel P
	Ball End Taper Mills	37	Cermet	Cast Iron K	Titanium S	Non-Ferrous N	Stainless M	Steel P

Cermet	Hardened	Cast Iron	Titanium	Non-Ferrous	Stainless	Steel
H	K	S	N	M	P	

HIGH PERFORMANCE ENDMILLS (Page 38)









	High Performance Features	40						
	V4 Square Endmills	42	Cermet	Hardened H	Cast Iron K	Titanium S	Stainless M	Steel P
	V4 Ball Endmills	44	Cermet	Hardened H	Cast Iron K	Titanium S	Stainless M	Steel P
	V4 Corner Radius Endmills	46	Cermet	Hardened H	Cast Iron K	Titanium S	Stainless M	Steel P
	V5 Square Endmills	52	Cermet	Hardened H	Cast Iron K	Titanium S	Stainless M	Steel P
	V5 Ball Endmills	53	Cermet	Hardened H	Cast Iron K	Titanium S	Stainless M	Steel P
	V5 Corner Radius Endmills	54	Cermet	Hardened H	Cast Iron K	Titanium S	Stainless M	Steel P
	HY5 Square Endmills	59	Cermet	Hardened H	Cast Iron K	Titanium S	Stainless M	Steel P
	HY5 Corner Radius Endmills	61	Cermet	Hardened H	Cast Iron K	Titanium S	Stainless M	Steel P

TABLE OF CONTENTS

HIGH PERFORMANCE ENDMILLS Continued































	Cermet	Hardened	Cast Iron	Titanium	Non-Ferrous	Stainless	Steel
	C	H	K	S	N	M	P
 F45 6FL Square Endmills 67	C	H	K	S		M	P
 F45 6FL Corner Radius Endmills 68	C	H	K	S		M	P
 Mold Mills, Corner Radius Necked 69	C	H	K	S		M	P
 Mold Mills, CR Necked Long 70	C	H	K	S		M	P
 Mold Mills, Ball Necked 71	C	H	K	S		M	P
 Mold Mills, 45° Corner Chamfer Necked 72	C	H	K	S		M	P
 3FL 60° Helix Twister Mills 73				S		M	P
 Fine Pitch Roughers 74	C	H	K	S	N	M	P
 Medium Pitch Roughers 75	C	H	K	S	N	M	P
 Coarse Pitch Roughers 76	C	H	K	S	N	M	P
 Square End AxMills 77					N		
 Ball End AxMills 82					N		
 Corner Radius AxMills 85					N		
 Square End Chipbreaker AxMills 93					N		
 Ball End Chipbreaker AxMills 94					N		
 Square End Necked AxMills 95					N		
 Ball End Necked AxMills 96					N		
 Corner Radius Necked AxMills 97					N		
 45° 2 Flute Hypermills 98					N		
 45° 3 Flute Hypermills 98					N		
 55° AlumaZips 99					N		

TABLE OF CONTENTS

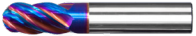
Cermet	Hardened	Cast Iron	Titanium	Non-Ferrous	Stainless	Steel
H	K	S	N	M	P	

PRO+ PERFORMANCE ENDMILLS (Page 100)

	V4 Pro+ Square Endmills . . . <i>V4P</i>	102	Cermet	Hardened	Cast Iron	Titanium	Stainless	Steel
	V4 Pro+ Ball Endmills. . . <i>V4P</i>	103	Cermet	Hardened	Cast Iron	Titanium	Stainless	Steel
	V4 Pro+ Corner Radius Endmills. . . <i>V4P</i>	104	Cermet	Hardened	Cast Iron	Titanium	Stainless	Steel
	V5 Pro+ Square Endmills . . . <i>V5P</i>	105	Cermet	Hardened	Cast Iron	Titanium	Stainless	Steel
	V5 Pro+ Ball Endmills. . . <i>V5P</i>	106	Cermet	Hardened	Cast Iron	Titanium	Stainless	Steel
	V5 Pro+ Corner Radius Endmills. . . <i>V5P</i>	107	Cermet	Hardened	Cast Iron	Titanium	Stainless	Steel
	HY5 Pro+ Square Endmills . . . <i>HY5</i>	108	Cermet	Hardened	Cast Iron	Titanium	Stainless	Steel
	HY5 Pro+ Corner Radius Endmills. . . <i>HY5</i>	109	Cermet	Hardened	Cast Iron	Titanium	Stainless	Steel
	F45 Pro+ Square Endmills. . . <i>F45</i>	110	Cermet	Hardened	Cast Iron	Titanium	Stainless	Steel
	F45 Pro+ Corner Radius Endmills . . . <i>F45</i>	110	Cermet	Hardened	Cast Iron	Titanium	Stainless	Steel
	V7 Pro+ Endmills . . . <i>V7</i>	111	Cermet	Hardened	Cast Iron	Titanium	Stainless	Steel

HIGH PERFORMANCE ROUTERS (Page 112)













	2 Flute Compression Routers.	114	Fiberglass	Graphite	Composite	Metal Matrix	Carbon Fiber	Honeycomb
	2 Flute Compression Chipbreaker Routers	115	Fiberglass	Graphite	Composite	Metal Matrix	Carbon Fiber	Honeycomb
	3 Flute Compression Routers.	116	Fiberglass	Graphite	Composite	Metal Matrix	Carbon Fiber	Honeycomb
	4 Flute Combination Compression Routers.	117	Fiberglass	Graphite	Composite	Metal Matrix	Carbon Fiber	Honeycomb
	4 Flute Compression Routers.	118	Fiberglass	Graphite	Composite	Metal Matrix	Carbon Fiber	Honeycomb
	4 Flute Fiberglass Mill End Routers	119	Fiberglass					
	Fiberglass and Composite Finishers	120	Fiberglass					
	OFX O-Flute Xtreme Routers	121					Plastics	
	CVD Nano Crystalline Routers	122	CRFP	Graphite	Composite		Carbon Fiber	Honeycomb

TABLE OF CONTENTS

CARBIDE DRILLS AND COUNTERSINKS (Page 124)		Cermet	Hardened	Cast Iron	Titanium	Non-Ferrous	Stainless	Steel
		H	K	S	N	M	P	
	Jobber Drills 126	Cermet	H	K	S	N	M	P
	Stub Drills. 131	Cermet	H	K	S	N	M	P
	Straight Flute Drills. 135	Cermet	H	K	S	N	M	P
	Spade Drills. 136	Cermet	H	K	S	N	M	P
	NC Spotting Drills. 137	Cermet	H	K	S	N	M	P
	Drill and Countersink / Center Drills 137	Cermet	H	K	S	N	M	P
	Countersinks, Single Flute 138		K	S	N	M	P	
	Countersinks, Three Flute 138		K	S	N	M	P	
	Countersinks, Six Flute 139		K	S	N	M	P	
	Chamfer Tools 139	H	K	S	N	M	P	

HIGH PERFORMANCE HURRICANE DRILLS (Page 140)

	Hurricane 3XD Non-Coolant Through & Coolant Through . . . 142	H	K	S	N	M	P
	Hurricane 5XD Non-Coolant Through & Coolant Through . . . 146	H	K	S	N	M	P
	Hurricane 8XD Coolant Through 152	H	K	S	N	M	P

REAMERS (Page 156)



















	Straight Flute Reamers - 4 Flute 158	H	K	S	N	M	P
	Straight Flute Reamers - 6 Flute 159	H	K	S	N	M	P

TABLE OF CONTENTS

Cermet	Hardened	Cast Iron	Titanium	Non-Ferrous	Stainless	Steel
H	K	S	N	M	P	

BURS (Page 160)		Cermet	Hardened	Cast Iron	Titanium	Non-Ferrous	Stainless	Steel
		H	K	S	N	M	P	
	SA Burs - Cylindrical Shape, No Endcut 162	H	K	S	N	M	P	
	SB Burs - Cylindrical Shape with End Cut 163	H	K	S	N	M	P	
	SC Burs - Radius Cylindrical Shape 164	H	K	S	N	M	P	
	SD Burs - Ball Shape 165	H	K	S	N	M	P	
	SE Burs - Oval Shape 166	H	K	S	N	M	P	
	SF Burs - Radius Tree Shape 167	H	K	S	N	M	P	
	SG Burs - Pointed Tree Shape. 168	H	K	S	N	M	P	
	SH Burs - Flame Shape 169	H	K	S	N	M	P	
	SJ Burs - 60° Included Cone Shape 170	H	K	S	N	M	P	
	SK Burs - 90° Included Cone Shape 171	H	K	S	N	M	P	
	SL Burs - Radius Cone Shape 172	H	K	S	N	M	P	
	SM Burs - Pointed Cone Shape. 173	H	K	S	N	M	P	
	SN Burs - Inverted Cone Shape 174	H	K	S	N	M	P	
	Die Mills 175	H	K	S	N	M	P	
	Piloted Die Mills 175	H	K	S	N	M	P	

BUR ROUTERS (Page 176)

	Fiberglass Routers 176
---	----------------------------------

Fiberglass	Graphite	Composite	Carbon Fiber	Honeycomb
------------	----------	-----------	--------------	-----------

TABLE OF CONTENTS

SPECIAL APPLICATION BURS



Tire Burs 177

NA

BUR SETS & DISPLAYS (Page 178)



8-12 Piece Plastic Box Bur Sets 178

3-5 Piece Power Pouch Bur Sets 178

24 Piece Countertop Displays 179

Cermet	Hardened	Cast Iron	Titanium	Non-Ferrous	Stainless	Steel
H	K	S	N	M	P	
Cermet	Hardened	Cast Iron	Titanium	Non-Ferrous	Stainless	Steel
H	K	S	N	M	P	
Cermet	Hardened	Cast Iron	Titanium	Non-Ferrous	Stainless	Steel
H	K	S	N	M	P	

TECHNICAL INFORMATION (Page 180)

Quality Processes 181

Premier Coatings 182

Troubleshooting Guides. 184

Material Groupings 190

Technical Information for Endmills 192

Technical HP Router Information 196

Technical Information for Reamers 198

Technical Information for HP Drills 199

TERMS AND CONDITIONS (Page 200)

Terms and Conditions 200

Metric Sizes Available
Ask for our metric catalog today!

STANDARD ENDMILLS

































































































- **Square End**
- **Ball End**
- **Corner Radius**
- **Double End**
- **Drill Mills**
- **Mini Mills**
- **TaperMills**

















Customers' Needs Come First

Customers' Needs Come First! This is what truly matters to us. To ensure you the fastest possible service, we have assembled simulation, engineering, production scheduling, customer service, and inventory personnel into one unit. They collaborate on any and all special requests from you, the moment your request is received. They are dedicated and qualified to assist you with solutions, fast!

TABLE OF CONTENTS

	Square Endmills12						
	Ball Endmills15						
	Corner Radius Endmills18						
	6 Flute Square Endmills26						
	Square End - Double End Endmills27						
	Ball End - Double End Endmills29						
	Square End - Double End Endmills w/ Flat31						
	Ball End - Double End Endmills w/ Flat31						
	90° Drill Mills32						
	Square End, Straight Flute Endmills33						
	Ball End, Straight Flute Endmills33						
	Square End Mini Mills34						
	Ball End Mini Mills35						
	Square End Taper Mills36						
	Ball End Taper Mills37						

Features Legend

	2 Flutes Square		Plain shank		2 Flutes Ball		3 Flutes Ball
	3 Flutes Square		Flat Shank		4 Flutes Ball		Ball Endmill
	4 Flutes Square		Double End Square				
	6 Flutes Square		Double End Ball				
	Corner Radius		Square EndMill				

Coatings Legend



Please contact us for our full line of metric products.

Mastercut's Superior Carbide Blend – A-Gr-SiV (Active Grain Sized Volume)

Our superior tungsten carbide gives you the ability to be aggressive when you need to be. Growth inhibitors in our submicron carbide blanks maintain the most consistent grain size available, giving you superior hardness AND toughness.

SQUARE ENDMILLS

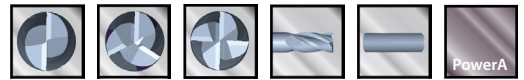

Standard, Stub and Long • 2, 3, & 4 Flutes Coated and Uncoated

- Genuine A-Gr-SiV submicron grain carbide
- Proven versatile performance
- MAP certified quality

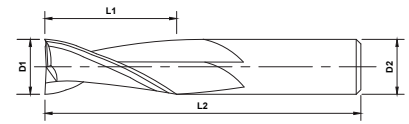
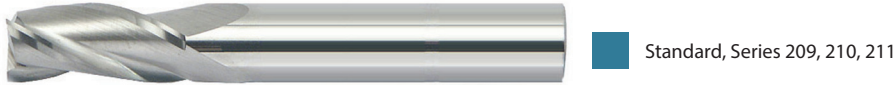

Length Key (K)



Quick Ship Items



K	OD	LOC	SHK	OAL	Uncoated			PowerA		
	D1	L1	D2	L2	2 Flute	3 Flute	4 Flute	2 Flute	3 Flute	4 Flute
1/32	1/16	1/8	1/8	1-1/2	213-102	-	213-702	213-102-1	-	213-702-1
		3/32	1/8	1-1/2	209-202	210-202	211-202	209-202-1	210-202-1	211-202-1
3/64	3/32	1/8	1/8	1-1/2	213-104	-	213-704	213-104-1	-	213-704-1
		1/8	1/8	1-1/2	209-204	210-204	211-204	209-204-1	210-204-1	211-204-1
1/16	1/8	1/8	1/8	1-1/2	213-106	-	213-706	213-106-1	-	213-706-1
		1/4	1/8	1-1/2	209-206	210-206	211-206	209-206-1	210-206-1	211-206-1
5/64	1/4	1/8	1-1/2	209-208	210-208	211-208	209-208-1	210-208-1	211-208-1	
3/32	3/16	1/8	1/8	1-1/2	213-108	-	213-708	213-108-1	-	213-708-1
		3/8	1/8	1-1/2	209-210	210-210	211-210	209-210-1	210-210-1	211-210-1
7/64	3/8	1/8	1/8	1-1/2	209-212	210-212	211-212	209-212-1	210-212-1	211-212-1
		1/4	1/8	1-1/2	213-112	-	213-712	213-112-1	-	213-712-1
1/8	1/2	1/8	1-1/2	209-214	210-214	211-214	209-214-1	210-214-1	211-214-1	
		5/8	1/8	2	204-202	-	206-202	204-202-1	-	206-202-1
	3/4	1/8	2	204-204	-	206-204	204-204-1	-	206-204-1	
		1	1/8	3	204-206	-	206-206	204-206-1	-	206-206-1
9/64	9/16	3/16	2	209-216	210-216	211-216	209-216-1	210-216-1	211-216-1	
5/32	5/16	3/16	2	213-110	-	213-710	213-110-1	-	213-710-1	
		9/16	3/16	2	209-218	210-218	211-218	209-218-1	210-218-1	211-218-1
11/64	9/16	3/16	2	209-220	210-220	211-220	209-220-1	210-220-1	211-220-1	
3/16	3/8	3/16	2	213-114	-	213-714	213-114-1	-	213-714-1	
		5/8	3/16	2	209-222	210-222	211-222	209-222-1	210-222-1	211-222-1
	3/4	3/16	2-1/2	204-208	-	206-208	204-208-1	-	206-208-1	
		1-1/8	3/16	3	204-210	-	206-210	204-210-1	-	206-210-1
13/64	1	3/16	4	204-212	-	206-212	204-212-1	-	206-212-1	
		5/8	1/4	2-1/2	209-224	210-224	211-224	209-224-1	210-224-1	211-224-1

Available with Weldon Flat - Add **W** to part ID for Weldon flat XXX-XXXW

SQUARE ENDMILLS

Standard, Stub and Long • 2, 3, & 4 Flutes Coated and Uncoated

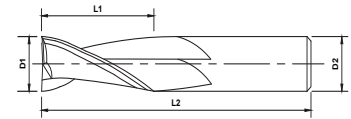
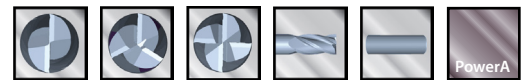

Length Key (K)

Standard
 Stub
 Long

Cermet
Cast Iron
K
Titanium
S
Non-Ferrous
N
Stainless
M
Steel
P

Quick Ship Items

K	OD	LOC	SHK	OAL	Uncoated			PowerA		
	D1	L1	D2	L2	2 Flute	3 Flute	4 Flute	2 Flute	3 Flute	4 Flute
	7/32	7/16	1/4	2	213-116	-	213-716	213-116-1	-	213-716-1
		5/8	1/4	2-1/2	209-226	210-226	211-226	209-226-1	210-226-1	211-226-1
	15/64	3/4	1/4	2-1/2	209-228	210-228	211-228	209-228-1	210-228-1	211-228-1
		1/2	1/4	2	213-118	-	213-718	213-118-1	-	213-718-1
	1/4	3/4	1/4	2-1/2	209-230	210-230	211-230	209-230-1	210-230-1	211-230-1
		1-1/8	1/4	3	204-214	-	206-214	204-214-1	-	206-214-1
		1	1/4	4	204-216	-	206-216	204-216-1	-	206-216-1
		1-1/2	1/4	4	204-218	-	206-218	204-218-1	-	206-218-1
		1-1/2	1/4	6	204-220	-	206-220	204-220-1	-	206-220-1
	17/64	7/8	5/16	2-1/2	209-232	210-232	211-232	209-232-1	210-232-1	211-232-1
	9/32	7/8	5/16	2-1/2	209-234	210-234	211-234	209-234-1	210-234-1	211-234-1
	19/64	7/8	5/16	2-1/2	209-236	210-236	211-236	209-236-1	210-236-1	211-236-1
	5/16	1/2	5/16	2	213-120	-	213-720	213-120-1	-	213-720-1
		7/8	5/16	2-1/2	209-238	210-238	211-238	209-238-1	210-238-1	211-238-1
		1-1/8	5/16	3	204-222	-	206-222	204-222-1	-	206-222-1
		1	5/16	4	204-224	-	206-224	204-224-1	-	206-224-1
		1-5/8	5/16	4	204-226	-	206-226	204-226-1	-	206-226-1
		1-1/2	5/16	6	204-228	-	206-228	204-228-1	-	206-228-1
	21/64	7/8	3/8	2-1/2	209-240	210-240	211-240	209-240-1	210-240-1	211-240-1
	11/32	7/8	3/8	2-1/2	209-242	210-242	211-242	209-242-1	210-242-1	211-242-1
	23/64	7/8	3/8	2-1/2	209-244	210-244	211-244	209-244-1	210-244-1	211-244-1
	3/8	5/8	3/8	2	213-122	-	213-722	213-122-1	-	213-722-1
		7/8	3/8	2-1/2	209-246	210-246	211-246	209-246-1	210-246-1	211-246-1
		1-1/8	3/8	3	204-230	-	206-230	204-230-1	-	206-230-1
		1-3/4	3/8	4	204-232	-	206-232	204-232-1	-	206-232-1
		2	3/8	4	204-234	-	206-234	204-234-1	-	206-234-1
		1-1/2	3/8	6	204-236	-	206-236	204-236-1	-	206-236-1
		3	3/8	6	204-238	-	206-238	204-238-1	-	206-238-1
	25/64	7/8	7/16	2-1/2	209-248	210-248	211-248	209-248-1	210-248-1	211-248-1
	13/32	7/8	7/16	2-1/2	209-250	210-250	211-250	209-250-1	210-250-1	211-250-1
	27/64	7/8	7/16	2-1/2	209-252	210-252	211-252	209-252-1	210-252-1	211-252-1

Available with Weldon Flat - Add **W** to part ID for Weldon flat XXX-XXXW

SQUARE ENDMILLS

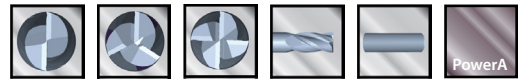

Standard, Stub and Long • 2, 3, & 4 Flutes Coated and Uncoated

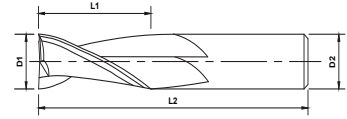

Length Key (K)



Quick Ship Items

K	OD	LOC	SHK	OAL	Uncoated			PowerA			
	D1	L1	D2	L2	2 Flute	3 Flute	4 Flute	2 Flute	3 Flute	4 Flute	
7/16	7/16	5/8	7/16	2-1/2	213-124	-	213-724	213-124-1	-	213-724-1	
		1	7/16	2-1/2	209-254	210-254	211-254	209-254-1	210-254-1	211-254-1	
		1	7/16	4	204-240	-	206-240	204-240-1	-	206-240-1	
		2	7/16	4	204-242	-	206-242	204-242-1	-	206-242-1	
		1-1/2	7/16	6	204-244	-	206-244	204-244-1	-	206-244-1	
		3	7/16	6	204-246	-	206-246	204-246-1	-	206-246-1	
29/64	29/64	1	1/2	3	209-256	210-256	211-256	209-256-1	210-256-1	211-256-1	
		15/32	1	1/2	3	209-258	210-258	211-258	209-258-1	210-258-1	211-258-1
		31/64	1	1/2	3	209-260	210-260	211-260	209-260-1	210-260-1	211-260-1
1/2	1/2	5/8	1/2	2-1/2	213-126	-	213-726	213-126-1	-	213-726-1	
		1	1/2	3	209-262	210-262	211-262	209-262-1	210-262-1	211-262-1	
		1	1/2	4	204-248	-	206-248	204-248-1	-	206-248-1	
		1-1/2	1/2	6	204-250	-	206-250	204-250-1	-	206-250-1	
		2	1/2	4	204-252	-	206-252	204-252-1	-	206-252-1	
		3	1/2	6	204-254	-	206-254	204-254-1	-	206-254-1	
9/16	9/16	1-1/4	9/16	3-1/2	209-264	210-264	211-264	209-264-1	210-264-1	211-264-1	
		5/8	3/4	5/8	3	213-128	-	213-728	213-128-1	-	213-728-1
			1-1/4	5/8	3-1/2	209-266	210-266	211-266	209-266-1	210-266-1	211-266-1
			2-1/4	5/8	5	204-256	-	206-256	204-256-1	-	206-256-1
11/16	11/16	3	5/8	6	204-258	-	206-258	204-258-1	-	206-258-1	
		3/4	1-1/2	3/4	4	209-268	210-268	211-268	209-268-1	210-268-1	211-268-1
			1	3/4	3	213-130	-	213-730	213-130-1	-	213-730-1
			1-1/2	3/4	4	209-270	210-270	211-270	209-270-1	210-270-1	211-270-1
2-1/4	3/4		5	204-260	-	206-260	204-260-1	-	206-260-1		
7/8	7/8	3	3/4	6	204-262	-	206-262	204-262-1	-	206-262-1	
		1	1-1/2	7/8	4	209-272	210-272	211-272	209-272-1	210-272-1	211-272-1
			1	1	3	213-132	-	213-732	213-132-1	-	213-732-1
			1-1/2	1	4	209-274	210-274	211-274	209-274-1	210-274-1	211-274-1
2	1		6	204-264	-	206-264	204-264-1	-	206-264-1		
1-1/4	1-1/4	3	1	6	204-266	-	206-266	204-266-1	-	206-266-1	
		4	1	6	204-268	-	206-268	204-268-1	-	206-268-1	
		2	1-1/4	4-1/2	209-276	210-276	211-276	209-276-1	210-276-1	211-276-1	

Available with Weldon Flat - Add **W** to part ID for Weldon flat XXX-XXXW

BALL ENDMILLS

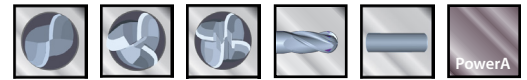

Standard, Stub and Long • 2, 3, & 4 Flutes Coated and Uncoated

- Genuine **A-Gr-SiV** submicron grain carbide
- Proven versatile performance
- MAP certified quality



Stub, Series 213



Standard, Series 209, 210, 211



Long, Series 204, 206

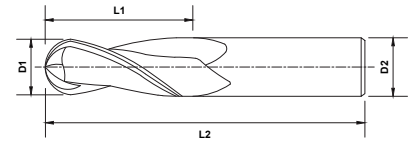

Length Key (K)

Standard Stub Long



Quick Ship Items

K	OD	LOC	SHK	OAL	Uncoated			PowerA		
	D1	L1	D2	L2	2 Flute	3 Flute	4 Flute	2 Flute	3 Flute	4 Flute
Stub	1/32	1/16	1/8	1-1/2	213-002	-	213-602	213-002-1	-	213-602-1
		3/32	1/8	1-1/2	209-002	210-002	211-002	209-002-1	210-002-1	211-002-1
Stub	3/64	3/32	1/8	1-1/2	213-004	-	213-604	213-004-1	-	213-604-1
		1/8	1/8	1-1/2	209-004	210-004	211-004	209-004-1	210-004-1	211-004-1
Stub	1/16	1/8	1/8	1-1/2	213-006	-	213-606	213-006-1	-	213-606-1
		1/4	1/8	1-1/2	209-006	210-006	211-006	209-006-1	210-006-1	211-006-1
Stub	5/64	1/4	1/8	1-1/2	209-008	210-008	211-008	209-008-1	210-008-1	211-008-1
		3/16	1/8	1-1/2	213-008	-	213-608	213-008-1	-	213-608-1
Stub	3/32	3/8	1/8	1-1/2	209-010	210-010	211-010	209-010-1	210-010-1	211-010-1
		7/64	1/8	1-1/2	209-012	210-012	211-012	209-012-1	210-012-1	211-012-1
Stub	1/8	1/4	1/8	1-1/2	213-012	-	213-612	213-012-1	-	213-612-1
		1/2	1/8	1-1/2	209-014	210-014	211-014	209-014-1	210-014-1	211-014-1
		5/8	1/8	2	204-002	-	206-002	204-002-1	-	206-002-1
		3/4	1/8	2	204-004	-	206-004	204-004-1	-	206-004-1
Stub	9/64	1	1/8	3	204-006	-	206-006	204-006-1	-	206-006-1
		9/16	3/16	2	209-016	210-016	211-016	209-016-1	210-016-1	211-016-1
Stub	5/32	5/16	3/16	2	213-010	-	213-610	213-010-1	-	213-610-1
		9/16	3/16	2	209-018	210-018	211-018	209-018-1	210-018-1	211-018-1
Stub	11/64	9/16	3/16	2	209-020	210-020	211-020	209-020-1	210-020-1	211-020-1
		3/8	3/16	2	213-014	-	213-614	213-014-1	-	213-614-1
Stub	3/16	5/8	3/16	2	209-022	210-022	211-022	209-022-1	210-022-1	211-022-1
		3/4	3/16	2-1/2	204-008	-	206-008	204-008-1	-	206-008-1
		1-1/8	3/16	3	204-010	-	206-010	204-010-1	-	206-010-1
		1	3/16	4	204-012	-	206-012	204-012-1	-	206-012-1
Stub	13/64	5/8	1/4	2-1/2	209-024	210-024	211-024	209-024-1	210-024-1	211-024-1
		7/16	1/4	2	213-016	-	213-616	213-016-1	-	213-616-1
Stub	7/32	5/8	1/4	2-1/2	209-026	210-026	211-026	209-026-1	210-026-1	211-026-1

Available with Weldon Flat - Add **W** to part ID for Weldon flat XXX-XXXW

BALL ENDMILLS

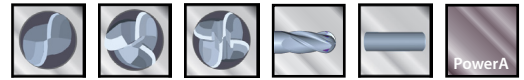

Standard, Stub and Long • 2, 3, & 4 Flutes Coated and Uncoated

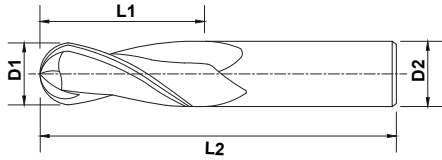

Length Key (K)

Standard
 Stub
 Long

Quick Ship Items

Cermet
Cast Iron
K
Titanium
S
Non-Ferrous
N
Stainless
M
Steel
P

K	OD	LOC	SHK	OAL	Uncoated			PowerA		
	D1	L1	D2	L2	2 Flute	3 Flute	4 Flute	2 Flute	3 Flute	4 Flute
15/64	1/4	3/4	1/4	2-1/2	209-028	210-028	211-028	209-028-1	210-028-1	211-028-1
		1/2	1/4	2	213-018	-	213-618	213-018-1	-	213-618-1
		3/4	1/4	2-1/2	209-030	210-030	211-030	209-030-1	210-030-1	211-030-1
		1-1/8	1/4	3	204-014	-	206-014	204-014-1	-	206-014-1
		1	1/4	4	204-016	-	206-016	204-016-1	-	206-016-1
		1-1/2	1/4	4	204-018	-	206-018	204-018-1	-	206-018-1
		1-1/2	1/4	6	204-020	-	206-020	204-020-1	-	206-020-1
17/64	7/8	5/16	2-1/2	209-032	210-032	211-032	209-032-1	210-032-1	211-032-1	
		9/32	5/16	2-1/2	209-034	210-034	211-034	209-034-1	210-034-1	211-034-1
19/64	5/16	7/8	2-1/2	209-036	210-036	211-036	209-036-1	210-036-1	211-036-1	
		1/2	2	213-020	-	213-620	213-020-1	-	213-620-1	
		7/8	2-1/2	209-038	210-038	211-038	209-038-1	210-038-1	211-038-1	
		1-1/8	3	204-022	-	206-022	204-022-1	-	206-022-1	
		1	4	204-024	-	206-024	204-024-1	-	206-024-1	
		1-5/8	4	204-026	-	206-026	204-026-1	-	206-026-1	
		1-1/2	6	204-028	-	206-028	204-028-1	-	206-028-1	
21/64	7/8	3/8	2-1/2	209-040	210-040	211-040	209-040-1	210-040-1	211-040-1	
		11/32	3/8	2-1/2	209-042	210-042	211-042	209-042-1	210-042-1	211-042-1
		23/64	3/8	2-1/2	209-044	210-044	211-044	209-044-1	210-044-1	211-044-1
3/8	3/8	5/8	2	213-022	-	213-622	213-022-1	-	213-622-1	
		7/8	2-1/2	209-046	210-046	211-046	209-046-1	210-046-1	211-046-1	
		1-1/8	3	204-030	-	206-030	204-030-1	-	206-030-1	
		1-3/4	4	204-032	-	206-032	204-032-1	-	206-032-1	
		2	4	204-034	-	206-034	204-034-1	-	206-034-1	
		1-1/2	6	204-036	-	206-036	204-036-1	-	206-036-1	
		3	6	204-038	-	206-038	204-038-1	-	206-038-1	
25/64	7/8	7/16	2-1/2	209-048	210-048	211-048	209-048-1	210-048-1	211-048-1	
		13/32	7/16	2-1/2	209-050	210-050	211-050	209-050-1	210-050-1	211-050-1
		27/64	7/16	2-1/2	209-052	210-052	211-052	209-052-1	210-052-1	211-052-1
7/16	7/16	5/8	2-1/2	213-024	-	213-624	213-024-1	-	213-624-1	
		1	2-1/2	209-054	210-054	211-054	209-054-1	210-054-1	211-054-1	
		1	4	204-040	-	206-040	204-040-1	-	206-040-1	

Available with Weldon Flat - Add **W** to part ID for Weldon flat XXX-XXXW

BALL ENDMILLS

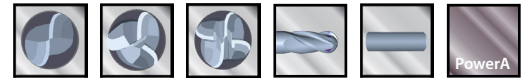

Standard, Stub and Long • 2, 3, & 4 Flutes Coated and Uncoated

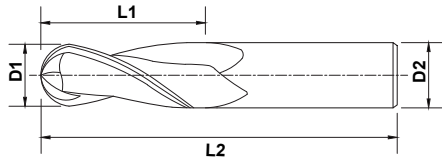

Length Key (K)

Standard Stub Long

Quick Ship Items



K	OD	LOC	SHK	OAL	Uncoated			PowerA			
	D1	L1	D2	L2	2 Flute	3 Flute	4 Flute	2 Flute	3 Flute	4 Flute	
7/16		2	7/16	4	204-042	-	206-042	204-042-1	-	206-042-1	
		1-1/2	7/16	6	204-044	-	206-044	204-044-1	-	206-044-1	
		3	7/16	6	204-046	-	206-046	204-046-1	-	206-046-1	
29/64		1	1/2	3	209-056	210-056	211-056	209-056-1	210-056-1	211-056-1	
		15/32	1	1/2	3	209-058	210-058	211-058	209-058-1	210-058-1	211-058-1
		31/64	1	1/2	3	209-060	210-060	211-060	209-060-1	210-060-1	211-060-1
1/2		5/8	1/2	2-1/2	213-026	-	213-626	213-026-1	-	213-626-1	
		1	1/2	3	209-062	210-062	211-062	209-062-1	210-062-1	211-062-1	
		1	1/2	4	204-048	-	206-048	204-048-1	-	206-048-1	
		1-1/2	1/2	6	204-050	-	206-050	204-050-1	-	206-050-1	
		2	1/2	4	204-052	-	206-052	204-052-1	-	206-052-1	
		3	1/2	6	204-054	-	206-054	204-054-1	-	206-054-1	
9/16		1-1/4	9/16	3-1/2	209-064	210-064	211-064	209-064-1	210-064-1	211-064-1	
5/8		3/4	5/8	3	213-028	-	213-628	213-028-1	-	213-628-1	
		1-1/4	5/8	3-1/2	209-066	210-066	211-066	209-066-1	210-066-1	211-066-1	
		2-1/4	5/8	5	204-056	-	206-056	204-056-1	-	206-056-1	
		3	5/8	6	204-058	-	206-058	204-058-1	-	206-058-1	
11/16		1-1/2	3/4	4	209-068	210-068	211-068	209-068-1	210-068-1	211-068-1	
3/4		1	3/4	3	213-030	-	213-630	213-030-1	-	213-630-1	
		1-1/2	3/4	4	209-070	210-070	211-070	209-070-1	210-070-1	211-070-1	
		2-1/4	3/4	5	204-060	-	206-060	204-060-1	-	206-060-1	
		3	3/4	6	204-062	-	206-062	204-062-1	-	206-062-1	
7/8		1-1/2	7/8	4	209-072	210-072	211-072	209-072-1	210-072-1	211-072-1	
1		1	1	3	213-032	-	213-632	213-032-1	-	213-632-1	
		1-1/2	1	4	209-074	210-074	211-074	209-074-1	210-074-1	211-074-1	
		2	1	6	204-064	-	206-064	204-064-1	-	206-064-1	
		3	1	6	204-066	-	206-066	204-066-1	-	206-066-1	
		4	1	6	204-068	-	206-068	204-068-1	-	206-068-1	
1-1/4		2	1-1/4	4-1/2	209-076	210-076	211-076	209-076-1	210-076-1	211-076-1	

Available with Weldon Flat - Add **W** to part ID for Weldon flat XXX-XXXW

CORNER RADIUS ENDMILLS

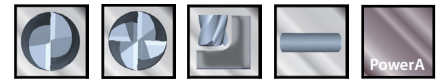

2, & 4 Flutes Coated and Uncoated

- Genuine A-Gr-SiV submicron grain carbide
- Corner radius for extra strength and precision
- MAP certified quality

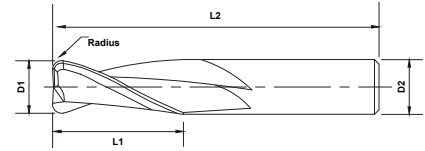

Standard, Series 209, 211



Long, Series 204, 206

Length Key (K)

Standard Stub Long



Quick Ship Items

K	OD	LOC	SHK	OAL	Radius	Uncoated		PowerA	
	D1	L1	D2	L2	R	2 Flute	4 Flute	2 Flute	4 Flute
1/8	1/8	1/2	1/8	1-1/2	.015	209-401	211-401	209-401-1	211-401-1
		1/2	1/8	1-1/2	.020	209-402	211-402	209-402-1	211-402-1
		1/2	1/8	1-1/2	.030	209-403	211-403	209-403-1	211-403-1
		1/2	1/8	1-1/2	.045	209-404	211-404	209-404-1	211-404-1
		1/2	1/8	1-1/2	.060	209-405	211-405	209-405-1	211-405-1
	3/16	1	1/8	3	.010	204-400	206-400	204-400-1	206-400-1
		1	1/8	3	.015	204-401	206-401	204-401-1	206-401-1
		1	1/8	3	.020	204-402	206-402	204-402-1	206-402-1
		1	1/8	3	.030	204-403	206-403	204-403-1	206-403-1
		1	1/8	3	.045	204-404	206-404	204-404-1	206-404-1
3/16	5/8	3/16	2	.015	209-411	211-411	209-411-1	211-411-1	
		3/16	2	.020	209-412	211-412	209-412-1	211-412-1	
		3/16	2	.030	209-413	211-413	209-413-1	211-413-1	
		3/16	2	.045	209-414	211-414	209-414-1	211-414-1	
		3/16	2	.060	209-415	211-415	209-415-1	211-415-1	
	1-1/8	3/16	3	.010	204-410	206-410	204-410-1	206-410-1	
		3/16	3	.015	204-411	206-411	204-411-1	206-411-1	
		3/16	3	.020	204-412	206-412	204-412-1	206-412-1	
		3/16	3	.030	204-413	206-413	204-413-1	206-413-1	
		3/16	3	.045	204-414	206-414	204-414-1	206-414-1	
		3/16	3	.060	204-415	206-415	204-415-1	206-415-1	
		1	3/16	4	.010	204-420	206-420	204-420-1	206-420-1
			3/16	4	.015	204-421	206-421	204-421-1	206-421-1
			3/16	4	.020	204-422	206-422	204-422-1	206-422-1
			3/16	4	.030	204-423	206-423	204-423-1	206-423-1
	3/16		4	.045	204-424	206-424	204-424-1	206-424-1	
	1	3/16	4	.060	204-425	206-425	204-425-1	206-425-1	

Available with Weldon Flat - Add **W** to part ID for Weldon flat XXX-XXXW

CORNER RADIUS ENDMILLS

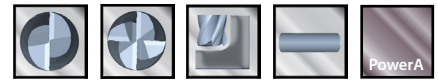

2, & 4 Flutes Coated and Uncoated

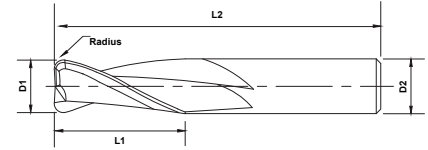

Length Key (K)

Standard
 Stub
 Long

Quick Ship Items

Cermet
Cast Iron
K
Titanium
S
Non-Ferrous
N
Stainless
M
Steel
P

K	OD	LOC	SHK	OAL	Radius	Uncoated		PowerA	
	D1	L1	D2	L2	R	2 Flute	4 Flute	2 Flute	4 Flute
1/4	1/2	1/4	2	.015	213-281	213-881	213-281-1	213-881-1	
	1/2	1/4	2	.020	213-282	213-882	213-282-1	213-882-1	
	1/2	1/4	2	.030	213-283	213-883	213-283-1	213-883-1	
	1/2	1/4	2	.045	213-284	213-884	213-284-1	213-884-1	
	1/2	1/4	2	.060	213-285	213-885	213-285-1	213-885-1	
	3/4	1/4	2-1/2	.015	209-421	211-421	209-421-1	211-421-1	
	3/4	1/4	2-1/2	.020	209-422	211-422	209-422-1	211-422-1	
	3/4	1/4	2-1/2	.030	209-423	211-423	209-423-1	211-423-1	
	3/4	1/4	2-1/2	.045	209-424	211-424	209-424-1	211-424-1	
	3/4	1/4	2-1/2	.060	209-425	211-425	209-425-1	211-425-1	
	1-1/8	1/4	3	.010	204-430	206-430	204-430-1	206-430-1	
	1-1/8	1/4	3	.015	204-431	206-431	204-431-1	206-431-1	
	1-1/8	1/4	3	.020	204-432	206-432	204-432-1	206-432-1	
	1-1/8	1/4	3	.030	204-433	206-433	204-433-1	206-433-1	
	1-1/8	1/4	3	.045	204-434	206-434	204-434-1	206-434-1	
	1-1/8	1/4	3	.060	204-435	206-435	204-435-1	206-435-1	
	1	1/4	4	.010	204-440	206-440	204-440-1	206-440-1	
	1	1/4	4	.015	204-441	206-441	204-441-1	206-441-1	
	1	1/4	4	.020	204-442	206-442	204-442-1	206-442-1	
	1	1/4	4	.030	204-443	206-443	204-443-1	206-443-1	
	1	1/4	4	.045	204-444	206-444	204-444-1	206-444-1	
	1	1/4	4	.060	204-445	206-445	204-445-1	206-445-1	
	1-1/2	1/4	4	.010	204-450	206-450	204-450-1	206-450-1	
	1-1/2	1/4	4	.015	204-451	206-451	204-451-1	206-451-1	
	1-1/2	1/4	4	.020	204-452	206-452	204-452-1	206-452-1	
	1-1/2	1/4	4	.030	204-453	206-453	204-453-1	206-453-1	
	1-1/2	1/4	4	.045	204-454	206-454	204-454-1	206-454-1	
	1-1/2	1/4	4	.060	204-455	206-455	204-455-1	206-455-1	
	1-1/2	1/4	6	.010	204-460	206-460	204-460-1	206-460-1	
	1-1/2	1/4	6	.015	204-461	206-461	204-461-1	206-461-1	
1-1/2	1/4	6	.020	204-462	206-462	204-462-1	206-462-1		
1-1/2	1/4	6	.030	204-463	206-463	204-463-1	206-463-1		
1-1/2	1/4	6	.045	204-464	206-464	204-464-1	206-464-1		
1-1/2	1/4	6	.060	204-465	206-465	204-465-1	206-465-1		

Available with Weldon Flat - Add **W** to part ID for Weldon flat XXX-XXXW

CORNER RADIUS ENDMILLS



2, & 4 Flutes Coated and Uncoated

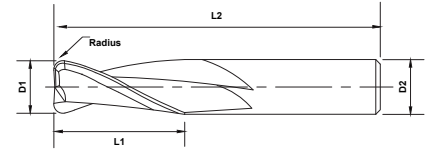

Length Key (K)

Standard
 Stub
 Long

Quick Ship Items



K	OD	LOC	SHK	OAL	Radius	Uncoated		PowerA	
	D1	L1	D2	L2	R	2 Flute	4 Flute	2 Flute	4 Flute
5/16	13/16	5/16	2-1/2	.015	209-431	211-431	209-431-1	211-431-1	
	13/16	5/16	2-1/2	.020	209-432	211-432	209-432-1	211-432-1	
	13/16	5/16	2-1/2	.030	209-433	211-433	209-433-1	211-433-1	
	13/16	5/16	2-1/2	.045	209-434	211-434	209-434-1	211-434-1	
	13/16	5/16	2-1/2	.060	209-435	211-435	209-435-1	211-435-1	
	1-1/8	5/16	3	.010	204-470	206-470	204-470-1	206-470-1	
	1-1/8	5/16	3	.015	204-471	206-471	204-471-1	206-471-1	
	1-1/8	5/16	3	.020	204-472	206-472	204-472-1	206-472-1	
	1-1/8	5/16	3	.030	204-473	206-473	204-473-1	206-473-1	
	1-1/8	5/16	3	.045	204-474	206-474	204-474-1	206-474-1	
	1-1/8	5/16	3	.060	204-475	206-475	204-475-1	206-475-1	
	1-1/8	5/16	3	.090	204-476	206-476	204-476-1	206-476-1	
	1-1/8	5/16	3	.125	204-477	206-477	204-477-1	206-477-1	
	1-1/2	5/16	6	.010	204-540	206-540	204-540-1	206-540-1	
	1-1/2	5/16	6	.015	204-541	206-541	204-541-1	206-541-1	
	1-1/2	5/16	6	.020	204-542	206-542	204-542-1	206-542-1	
	1-1/2	5/16	6	.030	204-543	206-543	204-543-1	206-543-1	
	1-1/2	5/16	6	.045	204-544	206-544	204-544-1	206-544-1	
	1-1/2	5/16	6	.060	204-545	206-545	204-545-1	206-545-1	
	1-1/2	5/16	6	.090	204-546	206-546	204-546-1	206-546-1	
	1-1/2	5/16	6	.125	204-547	206-547	204-547-1	206-547-1	
	1-5/8	5/16	4	.015	204-481	206-481	204-481-1	206-481-1	
	1-5/8	5/16	4	.020	204-482	206-482	204-482-1	206-482-1	
	1-5/8	5/16	4	.030	204-483	206-483	204-483-1	206-483-1	
	1-5/8	5/16	4	.045	204-484	206-484	204-484-1	206-484-1	
	1-5/8	5/16	4	.060	204-485	206-485	204-485-1	206-485-1	
	1-5/8	5/16	4	.090	204-486	206-486	204-486-1	206-486-1	
	1-5/8	5/16	4	.125	204-487	206-487	204-487-1	206-487-1	

Available with Weldon Flat - Add **W** to part ID for Weldon flat XXX-XXXW

CORNER RADIUS ENDMILLS



2, & 4 Flutes Coated and Uncoated

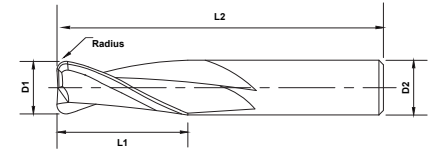

Length Key (K)

Standard
 Stub
 Long

Quick Ship Items

Cermet
Cast Iron
K
Titanium
S
Non-Ferrous
N
Stainless
M
Steel
P

K	OD	LOC	SHK	OAL	Radius	Uncoated		PowerA	
	D1	L1	D2	L2	R	2 Flute	4 Flute	2 Flute	4 Flute
3/8	1	3/8	2-1/2	.015	209-441	211-441	209-441-1	211-441-1	
	1	3/8	2-1/2	.020	209-442	211-442	209-442-1	211-442-1	
	1	3/8	2-1/2	.030	209-443	211-443	209-443-1	211-443-1	
	1	3/8	2-1/2	.045	209-444	211-444	209-444-1	211-444-1	
	1	3/8	2-1/2	.060	209-445	211-445	209-445-1	211-445-1	
	1-1/8	3/8	3	.010	204-490	206-490	204-490-1	206-490-1	
	1-1/8	3/8	3	.015	204-491	206-491	204-491-1	206-491-1	
	1-1/8	3/8	3	.020	204-492	206-492	204-492-1	206-492-1	
	1-1/8	3/8	3	.030	204-493	206-493	204-493-1	206-493-1	
	1-1/8	3/8	3	.045	204-494	206-494	204-494-1	206-494-1	
	1-1/8	3/8	3	.060	204-495	206-495	204-495-1	206-495-1	
	1-1/8	3/8	3	.090	204-496	206-496	204-496-1	206-496-1	
	1-1/8	3/8	3	.125	204-497	206-497	204-497-1	206-497-1	
	1-3/4	3/8	4	.010	204-500	206-500	204-500-1	206-500-1	
	1-3/4	3/8	4	.015	204-501	206-501	204-501-1	206-501-1	
	1-3/4	3/8	4	.020	204-502	206-502	204-502-1	206-502-1	
	1-3/4	3/8	4	.030	204-503	206-503	204-503-1	206-503-1	
	1-3/4	3/8	4	.045	204-504	206-504	204-504-1	206-504-1	
	1-3/4	3/8	4	.060	204-505	206-505	204-505-1	206-505-1	
	1-3/4	3/8	4	.090	204-506	206-506	204-506-1	206-506-1	
	1-3/4	3/8	4	.125	204-507	206-507	204-507-1	206-507-1	
	2	3/8	4	.010	204-510	206-510	204-510-1	206-510-1	
	2	3/8	4	.015	204-511	206-511	204-511-1	206-511-1	
	2	3/8	4	.020	204-512	206-512	204-512-1	206-512-1	
	2	3/8	4	.030	204-513	206-513	204-513-1	206-513-1	
	2	3/8	4	.045	204-514	206-514	204-514-1	206-514-1	
	2	3/8	4	.060	204-515	206-515	204-515-1	206-515-1	
	2	3/8	4	.090	204-516	206-516	204-516-1	206-516-1	
	2	3/8	4	.125	204-517	206-517	204-517-1	206-517-1	
	1-1/2	3/8	6	.010	204-520	206-520	204-520-1	206-520-1	
1-1/2	3/8	6	.015	204-521	206-521	204-521-1	206-521-1		
1-1/2	3/8	6	.020	204-522	206-522	204-522-1	206-522-1		

Available with Weldon Flat - Add **W** to part ID for Weldon flat XXX-XXXW

CORNER RADIUS ENDMILLS



2, & 4 Flutes Coated and Uncoated

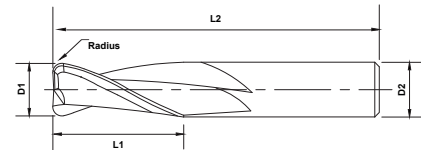

Length Key (K)

Standard Stub Long



Quick Ship Items

K	OD	LOC	SHK	OAL	Radius	Uncoated		PowerA	
	D1	L1	D2	L2	R	2 Flute	4 Flute	2 Flute	4 Flute
3/8	3/8	1-1/2	3/8	6	.030	204-523	206-523	204-523-1	206-523-1
		1-1/2	3/8	6	.045	204-524	206-524	204-524-1	206-524-1
		1-1/2	3/8	6	.060	204-525	206-525	204-525-1	206-525-1
		1-1/2	3/8	6	.090	204-526	206-526	204-526-1	206-526-1
		1-1/2	3/8	6	.125	204-527	206-527	204-527-1	206-527-1
		3	3/8	6	.010	204-530	206-530	204-530-1	206-530-1
		3	3/8	6	.015	204-531	206-531	204-531-1	206-531-1
		3	3/8	6	.020	204-532	206-532	204-532-1	206-532-1
		3	3/8	6	.030	204-533	206-533	204-533-1	206-533-1
		3	3/8	6	.045	204-534	206-534	204-534-1	206-534-1
		3	3/8	6	.060	204-535	206-535	204-535-1	206-535-1
		3	3/8	6	.090	204-536	206-536	204-536-1	206-536-1
		3	3/8	6	.125	204-537	206-537	204-537-1	206-537-1
		7/16	7/16	2	7/16	4	.010	204-550	206-550
2	7/16			4	.015	204-551	206-551	204-551-1	206-551-1
2	7/16			4	.020	204-552	206-552	204-552-1	206-552-1
2	7/16			4	.030	204-553	206-553	204-553-1	206-553-1
2	7/16			4	.045	204-554	206-554	204-554-1	206-554-1
2	7/16			4	.060	204-555	206-555	204-555-1	206-555-1
2	7/16			4	.090	204-556	206-556	204-556-1	206-556-1
2	7/16			4	.125	204-557	206-557	204-557-1	206-557-1
3	7/16			6	.010	204-560	206-560	204-560-1	206-560-1
3	7/16			6	.015	204-561	206-561	204-561-1	206-561-1
3	7/16			6	.020	204-562	206-562	204-562-1	206-562-1
3	7/16			6	.030	204-563	206-563	204-563-1	206-563-1
3	7/16			6	.045	204-564	206-564	204-564-1	206-564-1
3	7/16			6	.060	204-565	206-565	204-565-1	206-565-1
3	7/16	6	.090	204-566	206-566	204-566-1	206-566-1		
3	7/16	6	.125	204-567	206-567	204-567-1	206-567-1		
1/2	1/2	1	1/2	3	.010	209-450	211-450	209-450-1	211-450-1
		1	1/2	3	.015	209-451	211-451	209-451-1	211-451-1
		1	1/2	3	.020	209-452	211-452	209-452-1	211-452-1
		1	1/2	3	.030	209-453	211-453	209-453-1	211-453-1

Available with Weldon Flat - Add **W** to part ID for Weldon flat XXX-XXXW

CORNER RADIUS ENDMILLS



2, & 4 Flutes Coated and Uncoated

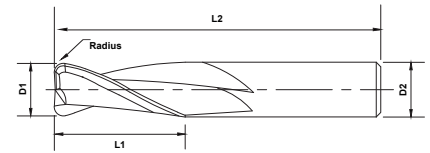

Length Key (K)

Standard
 Stub
 Long

Quick Ship Items

Cermet
K
S
N
M
P

K	OD	LOC	SHK	OAL	Radius	Uncoated		PowerA	
	D1	L1	D2	L2	R	2 Flute	4 Flute	2 Flute	4 Flute
1/2	1	1/2	3	.045	209-454	211-454	209-454-1	211-454-1	
	1	1/2	3	.060	209-455	211-455	209-455-1	211-455-1	
	1	1/2	3	.090	209-456	211-456	209-456-1	211-456-1	
	1	1/2	4	.010	204-570	206-570	204-570-1	206-570-1	
	1	1/2	4	.015	204-571	206-571	204-571-1	206-571-1	
	1	1/2	4	.020	204-572	206-572	204-572-1	206-572-1	
	1	1/2	4	.030	204-573	206-573	204-573-1	206-573-1	
	1	1/2	4	.045	204-574	206-574	204-574-1	206-574-1	
	1	1/2	4	.060	204-575	206-575	204-575-1	206-575-1	
	1	1/2	4	.090	204-576	206-576	204-576-1	206-576-1	
	1	1/2	4	.125	204-577	206-577	204-577-1	206-577-1	
	1-1/2	1/2	6	.010	204-580	206-580	204-580-1	206-580-1	
	1-1/2	1/2	6	.015	204-581	206-581	204-581-1	206-581-1	
	1-1/2	1/2	6	.020	204-582	206-582	204-582-1	206-582-1	
	1-1/2	1/2	6	.030	204-583	206-583	204-583-1	206-583-1	
	1-1/2	1/2	6	.045	204-584	206-584	204-584-1	206-584-1	
	1-1/2	1/2	6	.060	204-585	206-585	204-585-1	206-585-1	
	1-1/2	1/2	6	.090	204-586	206-586	204-586-1	206-586-1	
	1-1/2	1/2	6	.125	204-587	206-587	204-587-1	206-587-1	
	2	1/2	4	.010	204-590	206-590	204-590-1	206-590-1	
	2	1/2	4	.015	204-591	206-591	204-591-1	206-591-1	
	2	1/2	4	.020	204-592	206-592	204-592-1	206-592-1	
	2	1/2	4	.030	204-593	206-593	204-593-1	206-593-1	
	2	1/2	4	.045	204-594	206-594	204-594-1	206-594-1	
	2	1/2	4	.060	204-595	206-595	204-595-1	206-595-1	
	2	1/2	4	.090	204-596	206-596	204-596-1	206-596-1	
	2	1/2	4	.125	204-597	206-597	204-597-1	206-597-1	
	3	1/2	6	.010	204-600	206-600	204-600-1	206-600-1	
	3	1/2	6	.015	204-601	206-601	204-601-1	206-601-1	
	3	1/2	6	.020	204-602	206-602	204-602-1	206-602-1	
	3	1/2	6	.030	204-603	206-603	204-603-1	206-603-1	
	3	1/2	6	.045	204-604	206-604	204-604-1	206-604-1	
	3	1/2	6	.060	204-605	206-605	204-605-1	206-605-1	
	3	1/2	6	.090	204-606	206-606	204-606-1	206-606-1	
	3	1/2	6	.125	204-607	206-607	204-607-1	206-607-1	

Available with Weldon Flat - Add **W** to part ID for Weldon flat XXX-XXXW

CORNER RADIUS ENDMILLS



2, & 4 Flutes Coated and Uncoated

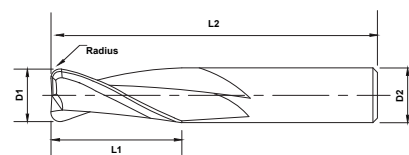

Length Key (K)

Standard Stub Long

Quick Ship Items



K	OD	LOC	SHK	OAL	Radius	Uncoated		PowerA	
	D1	L1	D2	L2	R	2 Flute	4 Flute	2 Flute	4 Flute
5/8	5/8	1-1/4	5/8	3-1/2	.015	209-461	211-461	209-461-1	211-461-1
		1-1/4	5/8	3-1/2	.020	209-462	211-462	209-462-1	211-462-1
		1-1/4	5/8	3-1/2	.030	209-463	211-463	209-463-1	211-463-1
		1-1/4	5/8	3-1/2	.045	209-464	211-464	209-464-1	211-464-1
		1-1/4	5/8	3-1/2	.060	209-465	211-465	209-465-1	211-465-1
		1-1/4	5/8	3-1/2	.090	209-466	211-466	209-466-1	211-466-1
		2-1/4	5/8	5	.010	204-610	206-610	204-610-1	206-610-1
		2-1/4	5/8	5	.015	204-611	206-611	204-611-1	206-611-1
		2-1/4	5/8	5	.020	204-612	206-612	204-612-1	206-612-1
		2-1/4	5/8	5	.030	204-613	206-613	204-613-1	206-613-1
	2-1/4	5/8	5	.045	204-614	206-614	204-614-1	206-614-1	
	2-1/4	5/8	5	.060	204-615	206-615	204-615-1	206-615-1	
	2-1/4	5/8	5	.090	204-616	206-616	204-616-1	206-616-1	
	2-1/4	5/8	5	.125	204-617	206-617	204-617-1	206-617-1	
	3	5/8	6	.010	204-620	206-620	204-620-1	206-620-1	
	3	5/8	6	.015	204-621	206-621	204-621-1	206-621-1	
	3	5/8	6	.020	204-622	206-622	204-622-1	206-622-1	
	3	5/8	6	.030	204-623	206-623	204-623-1	206-623-1	
	3	5/8	6	.045	204-624	206-624	204-624-1	206-624-1	
	3	5/8	6	.060	204-625	206-625	204-625-1	206-625-1	
3	5/8	6	.090	204-626	206-626	204-626-1	206-626-1		
3	5/8	6	.125	204-627	206-627	204-627-1	206-627-1		
3/4	3/4	1-1/2	3/4	4	.015	209-471	211-471	209-471-1	211-471-1
		1-1/2	3/4	4	.020	209-472	211-472	209-472-1	211-472-1
		1-1/2	3/4	4	.030	209-473	211-473	209-473-1	211-473-1
		1-1/2	3/4	4	.045	209-474	211-474	209-474-1	211-474-1
		1-1/2	3/4	4	.060	209-475	211-475	209-475-1	211-475-1
		1-1/2	3/4	4	.090	209-476	211-476	209-476-1	211-476-1
		2-1/4	3/4	5	.015	204-631	206-631	204-631-1	206-631-1
	2-1/4	3/4	5	.020	204-632	206-632	204-632-1	206-632-1	

Available with Weldon Flat - Add **W** to part ID for Weldon flat XXX-XXXW

CORNER RADIUS ENDMILLS



2, & 4 Flutes Coated and Uncoated

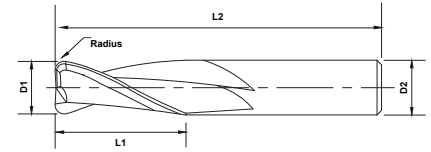

Length Key (K)

Standard
 Stub
 Long

Quick Ship Items

Cermet
K
S
N
M
P

K	OD	LOC	SHK	OAL	Radius	Uncoated		PowerA	
	D1	L1	D2	L2	R	2 Flute	4 Flute	2 Flute	4 Flute
3/4		2-1/4	3/4	5	.030	204-633	206-633	204-633-1	206-633-1
		2-1/4	3/4	5	.045	204-634	206-634	204-634-1	206-634-1
		2-1/4	3/4	5	.060	204-635	206-635	204-635-1	206-635-1
		2-1/4	3/4	5	.090	204-636	206-636	204-636-1	206-636-1
		2-1/4	3/4	5	.125	204-637	206-637	204-637-1	206-637-1
		3	3/4	6	.015	204-641	206-641	204-641-1	206-641-1
		3	3/4	6	.020	204-642	206-642	204-642-1	206-642-1
		3	3/4	6	.030	204-643	206-643	204-643-1	206-643-1
		3	3/4	6	.045	204-644	206-644	204-644-1	206-644-1
		3	3/4	6	.060	204-645	206-645	204-645-1	206-645-1
		3	3/4	6	.090	204-646	206-646	204-646-1	206-646-1
		3	3/4	6	.125	204-647	206-647	204-647-1	206-647-1
1		1-1/2	1	4	.015	209-481	211-481	209-481-1	211-481-1
		1-1/2	1	4	.020	209-482	211-482	209-482-1	211-482-1
		1-1/2	1	4	.030	209-483	211-483	209-483-1	211-483-1
		1-1/2	1	4	.045	209-484	211-484	209-484-1	211-484-1
		1-1/2	1	4	.060	209-485	211-485	209-485-1	211-485-1
		1-1/2	1	4	.090	209-486	211-486	209-486-1	211-486-1
		3	1	6	.015	204-651	206-651	204-651-1	206-651-1
		3	1	6	.020	204-652	206-652	204-652-1	206-652-1
		3	1	6	.030	204-653	206-653	204-653-1	206-653-1
		3	1	6	.045	204-654	206-654	204-654-1	206-654-1
		3	1	6	.060	204-655	206-655	204-655-1	206-655-1
		3	1	6	.090	204-656	206-656	204-656-1	206-656-1
3	1	6	.125	204-657	206-657	204-657-1	206-657-1		

Available with Weldon Flat - Add **W** to part ID for Weldon flat XXX-XXXW

6 FLUTE SQUARE ENDMILLS

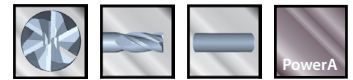

Standard Length - Coated and Uncoated

- Genuine A-Gr-SiV submicron grain carbide
- Proven versatile performance
- MAP certified quality

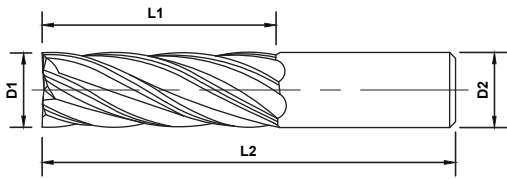

Series 212



Series 212, PowerA

Length Key (K)

Standard Stub Long



	OD	LOC	SHK	OAL	Uncoated	PowerA
K	D1	L1	D2	L2	6 Flute	6 Flute
Standard	3/16	5/8	3/16	2	212-222	212-222-1
	1/4	3/4	1/4	2-1/2	212-230	212-230-1
	5/16	7/8	5/16	2-1/2	212-238	212-238-1
	3/8	1	3/8	2-1/2	212-246	212-246-1
	7/16	1	7/16	2-1/2	212-254	212-254-1
	1/2	1	1/2	3	212-262	212-262-1
	5/8	1-1/4	5/8	3-1/2	212-266	212-266-1
	3/4	1-1/2	3/4	4	212-270	212-270-1
	7/8	1-1/2	7/8	4	212-272	212-272-1

SQUARE END - DOUBLE END

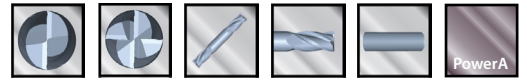

Standard, Stub and Long • 2 & 4 Flutes Coated and Uncoated

- Genuine *A-Gr-SiV* submicron grain carbide
- Proven versatile performance
- MAP certified quality

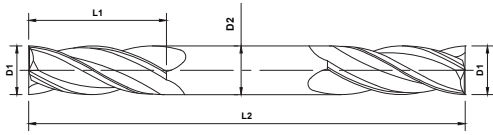

Standard, Series 201



Stub, Series 202

Standard, Series 201, PowerA

Stub, Series 202, PowerA

Length Key (K)

Standard Stub Long



K	OD	LOC	SHK	OAL	Uncoated		PowerA	
	D1	L1	D2	L2	2 Flute	4 Flute	2 Flute	4 Flute
1/32	1/32	1/16	1/8	1-1/2	202-102	202-302	202-102-1	202-302-1
		3/32	1/8	2	201-102	201-302	201-102-1	201-302-1
3/64	3/64	3/32	1/8	1-1/2	202-104	202-304	202-104-1	202-304-1
		1/8	1/8	2	201-104	201-304	201-104-1	201-304-1
1/16	1/16	1/8	1/8	1-1/2	202-106	202-306	202-106-1	202-306-1
		3/16	1/8	2	201-106	201-306	201-106-1	201-306-1
5/64	5/64	3/16	1/8	1-1/2	202-108	202-308	202-108-1	202-308-1
		3/16	1/8	1-1/2	202-110	202-310	202-110-1	202-310-1
3/32	3/32	1/4	1/8	2	201-108	201-308	201-108-1	201-308-1
		1/4	1/8	1-1/2	202-112	202-312	202-112-1	202-312-1
1/8	1/8	1/4	1/8	1-1/2	202-114	202-314	202-114-1	202-314-1
		3/8	1/8	2	201-110	201-310	201-110-1	201-310-1
5/32	5/32	5/16	3/16	2	202-116	202-316	202-116-1	202-316-1
		7/16	3/16	2-1/2	201-112	201-312	201-112-1	201-312-1
3/16	3/16	3/8	3/16	2	202-118	202-318	202-118-1	202-318-1
		1/2	3/16	2-1/2	201-114	201-314	201-114-1	201-314-1
7/32	7/32	1/2	1/4	2-1/2	202-120	202-320	202-120-1	202-320-1
		9/16	1/4	2-1/2	201-116	201-316	201-116-1	201-316-1
1/4	1/4	1/2	1/4	2-1/2	202-122	202-322	202-122-1	202-322-1
		5/8	1/4	2-1/2	201-118	201-318	201-118-1	201-318-1

Available with Weldon Flat - Add **W** to part ID for Weldon flat XXX-XXXW

SQUARE END - DOUBLE END

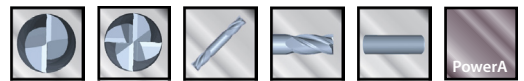

Standard, Stub and Long • 2 & 4 Flutes Coated and Uncoated

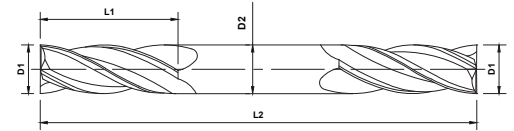

Length Key (K)

Standard Stub Long



K	OD	LOC	SHK	OAL	Uncoated		PowerA	
					2 Flute	4 Flute	2 Flute	4 Flute
5/16	5/16	1/2	5/16	2-1/2	202-124	202-324	202-124-1	202-324-1
		3/4	5/16	3-1/2	201-120	201-320	201-120-1	201-320-1
3/8	3/8	1/2	3/8	2-1/2	202-126	202-326	202-126-1	202-326-1
		3/4	3/8	3-1/2	201-122	201-322	201-122-1	201-322-1
7/16	7/16	1/2	7/16	2-1/2	202-128	202-328	202-128-1	202-328-1
		7/8	7/16	4	201-124	201-324	201-124-1	201-324-1
1/2	1/2	5/8	1/2	3	202-130	202-330	202-130-1	202-330-1
		1	1/2	4	201-126	201-326	201-126-1	201-326-1
9/16	9/16	1-1/4	9/16	6	201-128	201-328	201-128-1	201-328-1
		3/4	5/8	4	202-132	202-332	202-132-1	202-332-1
5/8	5/8	1-1/4	5/8	6	201-130	201-330	201-130-1	201-330-1
		1	3/4	4	202-134	202-334	202-134-1	202-334-1
3/4	3/4	1-1/2	3/4	6	201-132	201-332	201-132-1	201-332-1
		1-1/2	7/8	6	201-134	201-334	201-134-1	201-334-1
1	1	1-1/2	1	6	201-136	201-336	201-136-1	201-336-1

Available with Weldon Flat - Add **W** to part ID for Weldon flat XXX-XXXW

BALL END - DOUBLE END

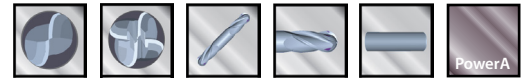

Standard, Stub and Long • 2 & 4 Flutes Coated and Uncoated

- Genuine *A-Gr-SiV* submicron grain carbide
- Proven versatile performance
- MAP certified quality



Stub, Series 202

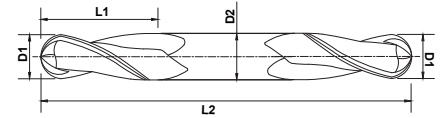

Standard, Series 201



Standard, Series 201, PowerA

Length Key (K)

Standard Stub Long



K	OD	LOC	SHK	OAL	Uncoated		PowerA	
					2 Flute	4 Flute	2 Flute	4 Flute
1/32	D1	1/16	1/8	1-1/2	202-002	202-202	202-002-1	202-202-1
		3/32	1/8	2	201-002	201-202	201-002-1	201-202-1
3/64	D1	3/32	1/8	1-1/2	202-004	202-204	202-004-1	202-204-1
		1/8	1/8	2	201-004	201-204	201-004-1	201-204-1
1/16	D1	1/8	1/8	1-1/2	202-006	202-206	202-006-1	202-206-1
		3/16	1/8	2	201-006	201-206	201-006-1	201-206-1
5/64	D1	3/16	1/8	1-1/2	202-008	202-208	202-008-1	202-208-1
		3/16	1/8	1-1/2	202-010	202-210	202-010-1	202-210-1
3/32	D1	1/4	1/8	2	201-008	201-208	201-008-1	201-208-1
		7/64	1/8	1-1/2	202-012	202-212	202-012-1	202-212-1
1/8	D1	1/4	1/8	1-1/2	202-014	202-214	202-014-1	202-214-1
		3/8	1/8	2	201-010	201-210	201-010-1	201-210-1
5/32	D1	5/16	3/16	2	202-016	202-216	202-016-1	202-216-1
		7/16	3/16	2-1/2	201-012	201-212	201-012-1	201-212-1
3/16	D1	3/8	3/16	2	202-018	202-218	202-018-1	202-218-1
		1/2	3/16	2-1/2	201-014	201-214	201-014-1	201-214-1
7/32	D1	1/2	1/4	2-1/2	202-020	202-220	202-020-1	202-220-1
		9/16	1/4	2-1/2	201-016	201-216	201-016-1	201-216-1
1/4	D1	1/2	1/4	2-1/2	202-022	202-222	202-022-1	202-222-1
		5/8	1/4	2-1/2	201-018	201-218	201-018-1	201-218-1

Available with Weldon Flat - Add **W** to part ID for Weldon flat XXX-XXXW

BALL END - DOUBLE END

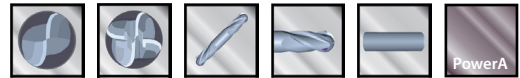

Standard, Stub and Long • 2 & 4 Flutes Coated and Uncoated

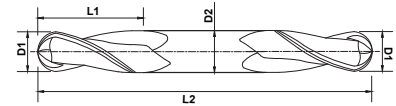

Length Key (K)

Standard
 Stub
 Long



K	OD	LOC	SHK	OAL	Uncoated		PowerA	
					2 Flute	4 Flute	2 Flute	4 Flute
	D1	L1	D2	L2				
	5/16	1/2	5/16	2-1/2	202-024	202-224	202-024-1	202-224-1
		3/4	5/16	3-1/2	201-020	201-220	201-020-1	201-220-1
	3/8	1/2	3/8	2-1/2	202-026	202-226	202-026-1	202-226-1
		3/4	3/8	3-1/2	201-022	201-222	201-022-1	201-222-1
	7/16	1/2	7/16	2-1/2	202-028	202-228	202-028-1	202-228-1
		7/8	7/16	4	201-024	201-224	201-024-1	201-224-1
	1/2	5/8	1/2	3	202-030	202-230	202-030-1	202-230-1
		1	1/2	4	201-026	201-226	201-026-1	201-226-1
	9/16	1-1/4	9/16	6	201-028	201-228	201-028-1	201-228-1
		3/4	5/8	4	202-032	202-232	202-032-1	202-232-1
	5/8	1-1/4	5/8	6	201-030	201-230	201-030-1	201-230-1
		1	3/4	4	202-034	202-234	202-034-1	202-234-1
	3/4	1-1/2	3/4	6	201-032	201-232	201-032-1	201-232-1
		1-1/2	7/8	6	201-034	201-234	201-034-1	201-234-1
	7/8	1-1/2	7/8	6	201-034	201-234	201-034-1	201-234-1
	1	1-1/2	1	6	201-036	201-236	201-036-1	201-236-1

Available with Weldon Flat - Add **W** to part ID for Weldon flat XXX-XXXW

SQUARE DOUBLE END WITH FLAT

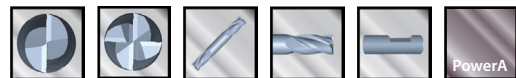

Common Shank with Flat • 2 and 4 Flutes • Coated and Uncoated

- Genuine *A-Gr-SiV* submicron grain carbide
- Proven versatile performance
- MAP certified quality

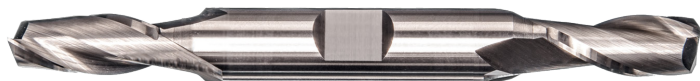

Series 200

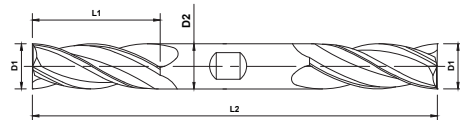

Length Key (K)

Standard
 Stub
 Long

Cermet
Cast Iron
K
Titanium
S
Non-Ferrous
N
Stainless
M
Steel
P

K	OD	LOC	SHK	OAL	Uncoated		PowerA	
					2 Flute	4 Flute	2 Flute	4 Flute
	D1	L1	D2	L2				
	1/8	3/8	3/8	3	200-102W	200-302W	200-102W-1	200-302W-1
	5/32	7/16	3/8	3-1/2	200-114W	200-314W	200-114W-1	200-314W-1
	3/16	1/2	3/8	3	200-104W	200-304W	200-104W-1	200-304W-1
	7/32	9/16	3/8	3	200-106W	200-306W	200-106W-1	200-306W-1
	1/4	5/8	3/8	3	200-108W	200-308W	200-108W-1	200-308W-1
	5/16	3/4	3/8	3-1/2	200-110W	200-310W	200-110W-1	200-310W-1
	3/8	3/4	3/8	3-1/2	200-112W	200-312W	200-112W-1	200-312W-1

'W' appended to a part number indicates this tool is manufactured with a flat on the shank.

BALL DOUBLE END WITH FLAT

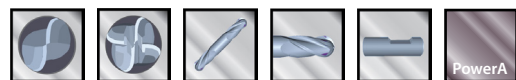

Common Shank with Flat • 2 and 4 Flutes • Coated and Uncoated

- Genuine *A-Gr-SiV* submicron grain carbide
- Proven versatile performance
- MAP certified quality

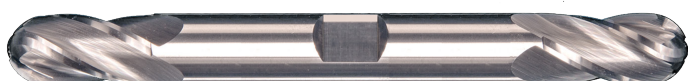

Series 200

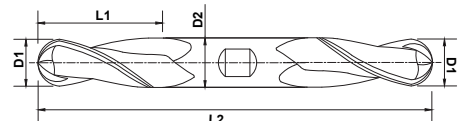

Length Key (K)

Standard
 Stub
 Long

Cermet
Cast Iron
K
Titanium
S
Non-Ferrous
N
Stainless
M
Steel
P

K	OD	LOC	SHK	OAL	Uncoated		PowerA	
					2 Flute	4 Flute	2 Flute	4 Flute
	D1	L1	D2	L2				
	1/8	3/8	3/8	3	200-002W	200-202W	200-002W-1	200-202W-1
	5/32	7/16	3/8	3-1/2	200-014W	200-214W	200-014W-1	200-214W-1
	3/16	1/2	3/8	3	200-004W	200-204W	200-004W-1	200-204W-1
	7/32	9/16	3/8	3	200-006W	200-206W	200-006W-1	200-206W-1
	1/4	5/8	3/8	3	200-008W	200-208W	200-008W-1	200-208W-1
	5/16	3/4	3/8	3-1/2	200-010W	200-210W	200-010W-1	200-210W-1
	3/8	3/4	3/8	3-1/2	200-012W	200-212W	200-012W-1	200-212W-1

'W' appended to a part number indicates this tool is manufactured with a flat on the shank.

90° DRILL MILLS

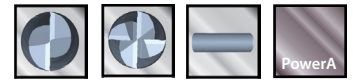

2 and 4 Flutes • Coated and Uncoated

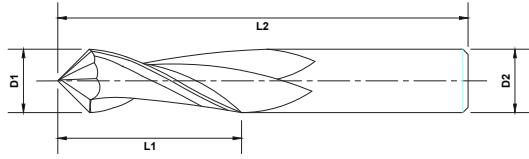

- Genuine A-Gr-SiV submicron grain carbide
- Chamfering, countersinking, spotting, and profile milling
- MAP certified quality



2 Flute, Series 214



4 Flute, Series 214



4 Flute, Series 214, PowerA

Length Key (K)

Standard Stub Long



K	OD	LOC	SHK	OAL	Uncoated		PowerA	
					2 Flute	4 Flute	2 Flute	4 Flute
	D1	L1	D2	L2				
	1/8	1/2	1/8	1-1/2	214-002	214-302	214-002-1	214-302-1
	3/16	5/8	3/16	2	214-004	214-304	214-004-1	214-304-1
	1/4	3/4	1/4	2-1/2	214-006	214-306	214-006-1	214-306-1
	5/16	7/8	5/16	2-1/2	214-008	214-308	214-008-1	214-308-1
	3/8	7/8	3/8	2-1/2	214-010	214-310	214-010-1	214-310-1
	7/16	1	7/16	2-1/2	214-012	214-312	214-012-1	214-312-1
	1/2	1	1/2	3	214-014	214-314	214-014-1	214-314-1
	5/8	1-1/4	5/8	3-1/2	214-016	214-316	214-016-1	214-316-1
	3/4	1-1/2	3/4	4	214-018	214-318	214-018-1	214-318-1

Available with Weldon Flat - Add **W** to part ID for Weldon flat XXX-XXXW

SQUARE END STRAIGHT FLUTE

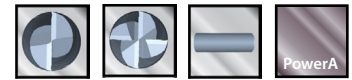

2 and 4 Flutes • Coated and Uncoated

- Genuine A-Gr-SiV submicron grain carbide
- Chamfering, countersinking, spotting, and profile milling
- MAP certified quality



Standard, Series 203

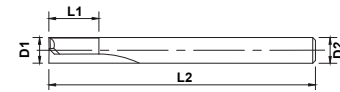

Length Key (K)

Standard Stub Long

Cast Iron **K** Steel **P** Hardened **H**

K	OD	LOC	SHK	OAL	Uncoated		PowerA	
	D1	L1	D2	L2	2 Flute	4 Flute	2 Flute	4 Flute
Standard	1/8	1/2	1/8	1-1/2	203-102	203-302	203-102-1	203-302-1
	3/16	5/8	3/16	2	203-104	203-304	203-104-1	203-304-1
	7/32	5/8	1/4	2-1/2	203-106	203-306	203-106-1	203-306-1
	1/4	3/4	1/4	2-1/2	203-108	203-308	203-108-1	203-308-1
	5/16	13/16	5/16	2-1/2	203-110	203-310	203-110-1	203-310-1
	3/8	1	3/8	2-1/2	203-112	203-312	203-112-1	203-312-1
	1/2	1	1/2	3	203-114	203-314	203-114-1	203-314-1
	5/8	1-1/4	5/8	3-1/2	203-116	203-316	203-116-1	203-316-1

Available with Weldon Flat - Add **W** to part ID for Weldon flat XXX-XXXW

BALL END STRAIGHT FLUTE

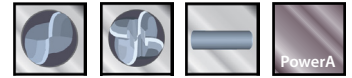

2 and 4 Flutes • Coated and Uncoated

- Genuine A-Gr-SiV submicron grain carbide
- Chamfering, countersinking, spotting, and profile milling
- MAP certified quality



Standard, Series 203

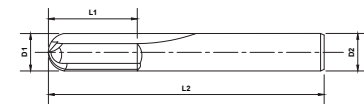

Length Key (K)

Standard Stub Long

Cast Iron **K** Steel **P** Hardened **H**

K	OD	LOC	SHK	OAL	Uncoated		PowerA	
	D1	L2	D2	L2	2 Flute	4 Flute	2 Flute	4 Flute
Standard	1/8	1/2	1/8	1-1/2	203-002	203-202	203-002-1	203-202-1
	3/16	5/8	3/16	2	203-004	203-204	203-004-1	203-204-1
	7/32	5/8	1/4	2-1/2	203-006	203-206	203-006-1	203-206-1
	1/4	3/4	1/4	2-1/2	203-008	203-208	203-008-1	203-208-1
	5/16	13/16	5/16	2-1/2	203-010	203-210	203-010-1	203-210-1
	3/8	1	3/8	2-1/2	203-012	203-212	203-012-1	203-212-1
	1/2	1	1/2	3	203-014	203-214	203-014-1	203-214-1
	5/8	1-1/4	5/8	3-1/2	203-016	203-216	203-016-1	203-216-1

Available with Weldon Flat - Add **W** to part ID for Weldon flat XXX-XXXW

SQUARE MINI MILLS

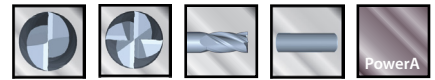

2 and 4 Flutes • Coated and Uncoated

- Genuine A-Gr-SiV submicron grain carbide
- Rigid, accurate design for micro applications
- MAP certified quality

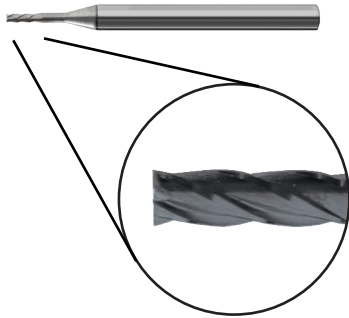

Standard, Series 207

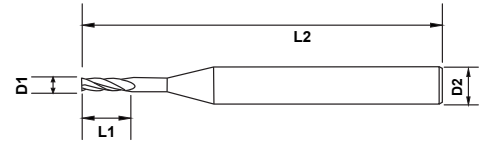

Length Key (K)

Standard Stub Long



K	OD	LOC	SHK	OAL	Uncoated		PowerA	
					2 Flute	4 Flute	2 Flute	4 Flute
	D1	L1	D2	L2				
	.005	.015	1/8	1-1/2	207-102	-	207-102-1	-
	.010	.030	1/8	1-1/2	207-104	207-504	207-104-1	207-504-1
	.015	.045	1/8	1-1/2	207-106	207-506	207-106-1	207-506-1
	.020	.060	1/8	1-1/2	207-108	207-508	207-108-1	207-508-1
	.025	.075	1/8	1-1/2	207-110	207-510	207-110-1	207-510-1
	.030	.090	1/8	1-1/2	207-112	207-512	207-112-1	207-512-1
	.035	.105	1/8	1-1/2	207-114	207-514	207-114-1	207-514-1
	.040	.120	1/8	1-1/2	207-116	207-516	207-116-1	207-516-1
	.045	.135	1/8	1-1/2	207-118	207-518	207-118-1	207-518-1
	.050	.150	1/8	1-1/2	207-120	207-520	207-120-1	207-520-1
	.055	.165	1/8	1-1/2	207-122	207-522	207-122-1	207-522-1
	.060	.180	1/8	1-1/2	207-124	207-524	207-124-1	207-524-1
	.065	.195	1/8	1-1/2	207-126	207-526	207-126-1	207-526-1
	.070	.210	1/8	1-1/2	207-128	207-528	207-128-1	207-528-1
	.075	.225	1/8	1-1/2	207-130	207-530	207-130-1	207-530-1
	.080	.240	1/8	1-1/2	207-132	207-532	207-132-1	207-532-1
	.085	.255	1/8	1-1/2	207-134	207-534	207-134-1	207-534-1
	.090	.270	1/8	1-1/2	207-136	207-536	207-136-1	207-536-1
	.095	.285	1/8	1-1/2	207-138	207-538	207-138-1	207-538-1
	.100	.300	1/8	1-1/2	207-140	207-540	207-140-1	207-540-1
	.105	.315	1/8	1-1/2	207-142	207-542	207-142-1	207-542-1
	.110	.330	1/8	1-1/2	207-144	207-544	207-144-1	207-544-1
	.115	.345	1/8	1-1/2	207-146	207-546	207-146-1	207-546-1
	.120	.360	1/8	1-1/2	207-148	207-548	207-148-1	207-548-1

*Call us regarding 3 flute Mini Mills and other flute configurations.

BALL MINI MILLS

2 and 4 Flutes • Coated and Uncoated

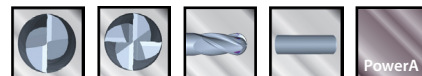

- Genuine A-Gr-SiV submicron grain carbide
- Rigid, accurate design for micro applications
- MAP certified quality

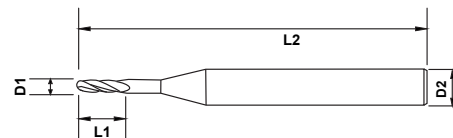
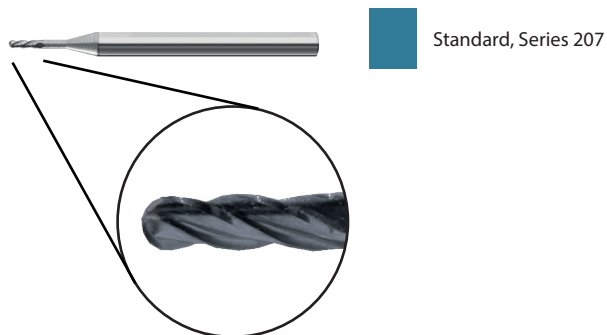

Length Key (K)

Standard
 Stub
 Long



K	OD	LOC	SHK	OAL	Uncoated		PowerA	
					2 Flute	4 Flute	2 Flute	4 Flute
	D1	L1	D2	L2	2 Flute	4 Flute	2 Flute	4 Flute
	.005	.015	1/8	1-1/2	207-002	-	207-002-1	-
	.010	.030	1/8	1-1/2	207-004	207-404	207-004-1	207-404-1
	.015	.045	1/8	1-1/2	207-006	207-406	207-006-1	207-406-1
	.020	.060	1/8	1-1/2	207-008	207-408	207-008-1	207-408-1
	.025	.075	1/8	1-1/2	207-010	207-410	207-010-1	207-410-1
	.030	.090	1/8	1-1/2	207-012	207-412	207-012-1	207-412-1
	.035	.105	1/8	1-1/2	207-014	207-414	207-014-1	207-414-1
	.040	.120	1/8	1-1/2	207-016	207-416	207-016-1	207-416-1
	.045	.135	1/8	1-1/2	207-018	207-418	207-018-1	207-418-1
	.050	.150	1/8	1-1/2	207-020	207-420	207-020-1	207-420-1
	.055	.165	1/8	1-1/2	207-022	207-422	207-022-1	207-422-1
	.060	.180	1/8	1-1/2	207-024	207-424	207-024-1	207-424-1
	.065	.195	1/8	1-1/2	207-026	207-426	207-026-1	207-426-1
	.070	.210	1/8	1-1/2	207-028	207-428	207-028-1	207-428-1
	.075	.225	1/8	1-1/2	207-030	207-430	207-030-1	207-430-1
	.080	.240	1/8	1-1/2	207-032	207-432	207-032-1	207-432-1
	.085	.255	1/8	1-1/2	207-034	207-434	207-034-1	207-434-1
	.090	.270	1/8	1-1/2	207-036	207-436	207-036-1	207-436-1
	.095	.285	1/8	1-1/2	207-038	207-438	207-038-1	207-438-1
	.100	.300	1/8	1-1/2	207-040	207-440	207-040-1	207-440-1
	.105	.315	1/8	1-1/2	207-042	207-442	207-042-1	207-442-1
	.110	.330	1/8	1-1/2	207-044	207-444	207-044-1	207-444-1
	.115	.345	1/8	1-1/2	207-046	207-446	207-046-1	207-446-1
	.120	.360	1/8	1-1/2	207-048	207-448	207-048-1	207-448-1

*Call us regarding 3 flute Mini Mills and other flute configurations.

SQUARE TAPERMILLS

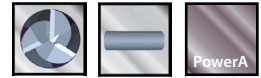

3 Flutes • Coated and Uncoated

- Genuine A-Gr-SiV submicron grain carbide
- Precise design, great versatility
- MAP certified quality

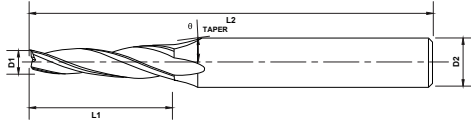

Series 208



Series 208, PowerA

Length Key (K)

Standard Stub Long



	Small OD	LOC	Degree	SHK	OAL	Uncoated	PowerA
K	D1	L1	θ	D2	L2	3 Flute	3 Flute
Standard	1/8	3/4	5	1/4	3	208-102	208-102-1
	1/8	1/2	7	1/4	3	208-104	208-104-1
	3/32	1/2	10	1/4	3	208-106	208-106-1
	1/8	1-1/2	5	3/8	3-1/2	208-108	208-108-1
	1/8	3/4	7	3/8	3-1/2	208-110	208-110-1
	1/8	3/4	10	3/8	3-1/2	208-112	208-112-1
	1/4	1-1/4	5	1/2	4	208-114	208-114-1
	3/16	1-1/4	7	1/2	4	208-116	208-116-1
	1/8	1	10	1/2	4	208-118	208-118-1

Available with Weldon Flat - Add **W** to part ID for Weldon flat XXX-XXXW

BALL TAPERMILLS

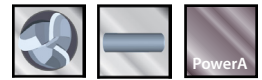

3 Flutes • Coated and Uncoated

- Genuine A-Gr-SiV submicron grain carbide
- Precise design, great versatility
- MAP certified quality

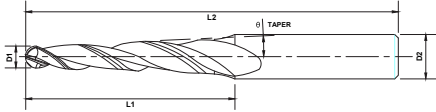

Series 208



Series 208, PowerA

Length Key (K)

Standard
 Stub
 Long



	Small OD	LOC	Degree	SHK	OAL	Uncoated	PowerA
K	D1	L1	θ	D2	L2	3 Flute	3 Flute
	1/8	3/4	5	1/4	3	208-002	208-002-1
	1/8	1/2	7	1/4	3	208-004	208-004-1
	3/32	1/2	10	1/4	3	208-006	208-006-1
	1/8	1-1/2	5	3/8	3-1/2	208-008	208-008-1
	1/8	3/4	7	3/8	3-1/2	208-010	208-010-1
	1/8	3/4	10	3/8	3-1/2	208-012	208-012-1
	1/4	1-1/4	5	1/2	4	208-014	208-014-1
	3/16	1-1/4	7	1/2	4	208-016	208-016-1
	1/8	1	10	1/2	4	208-018	208-018-1

Available with Weldon Flat - Add **W** to part ID for Weldon flat XXX-XXXW

















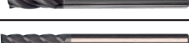







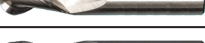

HIGH PERFORMANCE ENDMILLS

- **V4 and V5**
- **HY5**
- **F45**
- **Mold Mills**
- **TwisterMills**
- **Roughers**
- **AxMills**
- **45° HyperMills**
- **55° AlumaZips**

The customized geometries of our High Performance Endmills make these tools problem solvers for challenging milling operations.















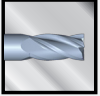



TABLE OF CONTENTS





	High Performance Features.	40								
	V4 Square Endmills . V4[®]	42	Cermet	Hardened H	Cast Iron K	Titanium S		Stainless M	Steel P	
	V4 Ball Endmills . V4[®]	44	Cermet	Hardened H	Cast Iron K	Titanium S		Stainless M	Steel P	
	V4 Corner Radius Endmills V4[®]	46	Cermet	Hardened H	Cast Iron K	Titanium S		Stainless M	Steel P	
	V5 Square Endmills . V5[®]	52	Cermet	Hardened H	Cast Iron K	Titanium S		Stainless M	Steel P	
	V5 Ball Endmills. . V5[®]	53	Cermet	Hardened H	Cast Iron K	Titanium S		Stainless M	Steel P	
	V5 Corner Radius Endmills. . V5[®]	54	Cermet	Hardened H	Cast Iron K	Titanium S		Stainless M	Steel P	
	HY5 Square Endmills. . HY5[®]	59	Cermet	Hardened H	Cast Iron K	Titanium S		Stainless M	Steel P	
	HY5 Corner Radius Endmills . HY5[®]	61	Cermet	Hardened H	Cast Iron K	Titanium S		Stainless M	Steel P	
	F45 6FL Square Endmills . F45[®]	67	Cermet	Hardened H	Cast Iron K	Titanium S		Stainless M	Steel P	
	F45 6FL Corner Radius Endmills. F45[®]	68	Cermet	Hardened H	Cast Iron K	Titanium S		Stainless M	Steel P	
	Mold Mills, Corner Radius Necked	69	Cermet	Hardened H	Cast Iron K	Titanium S		Stainless M	Steel P	
	Mold Mills, CR Necked Long	70	Cermet	Hardened H	Cast Iron K	Titanium S		Stainless M	Steel P	
	Mold Mills, Ball Necked	71	Cermet	Hardened H	Cast Iron K	Titanium S		Stainless M	Steel P	
	Mold Mills, 45° Corner Chamfer Necked	72	Cermet	Hardened H	Cast Iron K	Titanium S		Stainless M	Steel P	
	3FL 60° Helix Twister Mills.	73				Titanium S		Stainless M	Steel P	
	Fine Pitch Roughers	74	Cermet	Hardened H	Cast Iron K	Titanium S	Non-Ferrous N	Stainless M	Steel P	
	Medium Pitch Roughers	75	Cermet	Hardened H	Cast Iron K	Titanium S	Non-Ferrous N	Stainless M	Steel P	
	Coarse Pitch Roughers	76	Cermet	Hardened H	Cast Iron K	Titanium S	Non-Ferrous N	Stainless M	Steel P	
	Square End AxMills. AxMill[®]	77					Non-Ferrous N			
	Ball End AxMills . AxMill[®]	82					Non-Ferrous N			
	Corner Radius AxMills. AxMill[®]	85					Non-Ferrous N			
	Square End Chipbreaker AxMills. AxMill[®]	93					Non-Ferrous N			
	Ball End Chipbreaker AxMills. AxMill[®]	94					Non-Ferrous N			
	Square End Necked AxMills. AxMill[®]	95					Non-Ferrous N			
	Ball End Necked AxMills . AxMill[®]	96					Non-Ferrous N			
	Corner Radius Necked AxMills. AxMill[®]	97					Non-Ferrous N			
	45° 2 Flute Hypermills	98					Non-Ferrous N			
	45° 3 Flute Hypermills	98					Non-Ferrous N			
	55° AlumaZips.	99					Non-Ferrous N			

FEATURES AND COATING LEGENDS

Features Legend

	2 Flutes		Plain shank
	3 Flutes		Flat Shank
	4 Flutes		Double End Square
	5 Flutes		Double End Ball
	6 Flutes		Corner Radius
	2 Flutes Ball		3 Flutes Ball
	4 Flutes Ball		5 Flutes Ball
	Square End		Ball End

Coatings Legend

	PowerA Coating		PowerN Coating
	PowerT Coating		PowerZ Coating

Please contact us for our full line of metric products.

Mastercut's Superior Carbide Blend – A-Gr-SiV (Active Grain Sized Volume)

Our superior tungsten carbide gives you the ability to be aggressive when you need to be. Growth inhibitors in our submicron carbide blanks maintain the most consistent grain size available, giving you superior hardness AND toughness.

HIGH PERFORMANCE TOOL FEATURES



- The variable 4 flute design interrupts harmonic vibrations to provide improved feeds and speeds, superior finishes and longer tool life.
- Ideal for roughing to finishing operations, in both peripheral and slotting functions
- Available in our proprietary and proven PowerA (AlTiN) and the optional nanocomposite PowerNR (nACRo) for difficult-to-machine alloys
- Also see our Pro+ Performance V4 line



- An impressive combination of variable flutes, a thicker core and eccentrically-ground relief, adding to performance and value.
- A strong, stable performer sure to provide chatter-free finishes AND aggressive material removal rates.
- Available in PowerA (AlTiN) and nanocomposite PowerNR (nACRo) where tool-life demands the very finest coating available
- 5 Flute design

HIGH PERFORMANCE TOOL FEATURES



- High performing, broad spectrum semi-finisher/finisher
- Outstanding in stainless steels, high temp alloys, mold steels to 45 Rc
- 5 flute, 45° helix, eccentric grind provides a smooth cutting action with superb chip evacuation.
- 20% + increase in productivity versus 4 fluted endmills
- Minimal tool deflection equals better part tolerance
- Stub, standard and long lengths, in square end and corner radius options
- Coated with PowerA (AlTiN)



- 6 flute, high performance finisher providing superb finishes in stainless steels, nickel alloys, Inconels, titanium and more
- 45° degree helix provides superb chip evacuation and excellent shearing action.
- Reduced load pressures and super-stiff design promotes less chatter and the best performance in light finishing applications.
- Coated with PowerA (AlTiN)



- High performance design for aggressive aluminum milling
- Incorporates a high shear, high rake geometry
- 2 and 3 flute, square end, corner radius and ballend styles
- Available in uncoated and optional PowerZ (Zirconium Nitride) coating
- Chipbreaker option where chip control or spindle horsepower is a concern



HyperMill

- Aggressive metal removal rates in aluminum and non-ferrous materials
- 45° helix increases stiffness and improves surface finish.
- 2 and 3 Flute designs



AlumaZip

- High performance 2 Flute design for high metal removal rates in aluminum and non-ferrous materials
- 55° helix combines a super-stiff profile with a rapid evacuation of chips.
- High helix fluting increases contact area, thereby imparting better surface finishes.

V4 SQUARE ENDMILLS

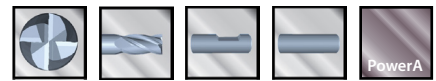

4 Flutes • Coated • With and without Flat

- High Performance A-Gr-SiV submicron grain carbide
- Unique variable helix design for faster speeds and feeds
- Quiet operation and better finish
- MAP certified quality

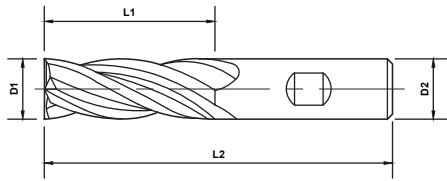

- Stub, Series 402, PowerA
- Standard, Series 400, PowerA
- Long, Series 401, PowerA



Length Key (K)

- Standard
- Stub
- Long



Quick Ship Items

K	OD	LOC	SHK	OAL	PowerA	
					No Flat	With Flat
1/8	1/8	1/4	1/8	1-1/2	402-004-1	-
		3/8	1/8	1-1/2	400-002-1	-
5/32	5/32	5/16	3/16	2	402-002-1	-
		7/16	3/16	2	400-004-1	-
3/16	3/16	3/8	3/16	2	402-006-1	-
		7/16	3/16	2	400-006-1	-
		3/4	3/16	2-1/2	400-042-1	-
7/32	7/32	7/16	1/4	2	402-008-1	-
		7/16	1/4	2-1/2	400-008-1	-
1/4	1/4	3/8	1/4	2	402-026-1	402-026W-1
		1/2	1/4	2	402-010-1	402-010W-1
		5/8	1/4	2-1/2	400-010-1	400-010W-1
		3/4	1/4	2-1/2	400-040-1	400-040W-1
		1-1/8	1/4	3	401-002-1	401-002W-1
5/16	5/16	1/2	5/16	2	402-012-1	402-012W-1
		13/16	5/16	2-1/2	400-012-1	400-012W-1
		1-1/8	5/16	3	401-004-1	401-004W-1
11/32	11/32	13/16	3/8	2-1/2	400-014-1	400-014W-1
		5/8	3/8	2	402-014-1	402-014W-1
3/8	3/8	7/8	3/8	2-1/2	400-016-1	400-016W-1
		1-1/8	3/8	3	401-006-1	401-006W-1
15/32	15/32	1	1/2	3	400-018-1	400-018W-1
7/16	7/16	5/8	7/16	2-1/2	402-016-1	402-016W-1
		1	7/16	2-3/4	400-020-1	400-020W-1

V4 SQUARE ENDMILLS



4 Flutes • Coated • With and without Flat

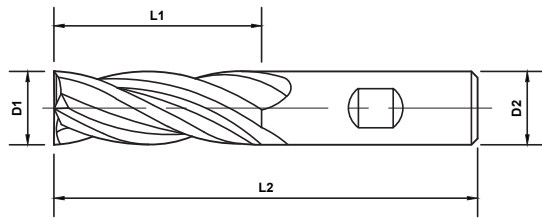

- High Performance A-Gr-SiV submicron grain carbide
- Unique variable helix design for faster speeds and feeds
- Quiet operation and better finish
- MAP certified quality

High Performance



Length Key (K)

Standard Stub Long

Quick Ship Items



K	OD	LOC	SHK	OAL	PowerA	
	D1	L1	D2	L2	No Flat	With Flat
1/2	1/2	5/8	1/2	2-1/2	402-018-1	402-018W-1
		1	1/2	3	400-022-1	400-022W-1
		1-1/4	1/2	3	400-024-1	400-024W-1
		2	1/2	4	401-008-1	401-008W-1
9/16	9/16	3-1/2	400-026-1	400-026W-1		
5/8	5/8	3/4	5/8	3	402-020-1	402-020W-1
		1-1/4	5/8	3-1/2	400-028-1	400-028W-1
		2-1/4	5/8	5	401-010-1	401-010W-1
3/4	3/4	1	3/4	3	402-024-1	402-024W-1
		7/8	3/4	3-1/2	402-022-1	402-022W-1
		1-1/2	3/4	4	400-030-1	400-030W-1
		1-5/8	3/4	4	400-032-1	400-032W-1
		2-1/4	3/4	5	401-012-1	401-012W-1
		3	3/4	6	401-014-1	401-014W-1
		4	3/4	6	401-016-1	401-016W-1
1	1	1-1/2	1	4	400-034-1	400-034W-1
		2-1/4	1	5	401-018-1	401-018W-1
		3	1	6	401-020-1	401-020W-1
		4	1	7	401-022-1	401-022W-1

V4 BALL ENDMILLS

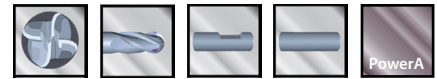

4 Flutes • Coated • With and without Flat

- High Performance A-Gr-SiV submicron grain carbide
- Unique variable helix design for faster speeds and feeds
- Quiet operation and better finish
- MAP certified quality

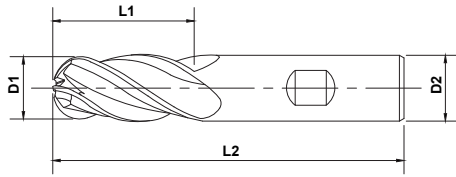

- Stub, Series 402, PowerA
- Standard, Series 400, PowerA
- Long, Series 401, PowerA

Length Key (K)

- Standard
- Stub
- Long

Quick Ship Items



K	OD	LOC	SHK	OAL	PowerA	
	D1	L1	D2	L2	No Flat	With Flat
1/8	1/8	1/4	1/8	1-1/2	402-204-1	-
		3/8	1/8	1-1/2	400-202-1	-
5/32	5/32	5/16	3/16	2	402-202-1	-
		7/16	3/16	2	400-204-1	-
3/16	3/16	3/8	3/16	2	402-206-1	-
		7/16	3/16	2	400-206-1	-
		3/4	3/16	2-1/2	400-242-1	-
7/32	7/32	7/16	1/4	2	402-208-1	-
		7/16	1/4	2-1/2	400-208-1	-
1/4	1/4	3/8	1/4	2	402-226-1	402-226W-1
		1/2	1/4	2	402-210-1	402-210W-1
		5/8	1/4	2-1/2	400-210-1	400-210W-1
		3/4	1/4	2-1/2	400-240-1	400-240W-1
		1-1/8	1/4	3	401-202-1	401-202W-1
5/16	5/16	1/2	5/16	2	402-212-1	402-212W-1
		13/16	5/16	2-1/2	400-212-1	400-212W-1
		1-1/8	5/16	3	401-204-1	401-204W-1
11/32	11/32	13/16	3/8	2-1/2	400-214-1	400-214W-1
3/8	3/8	5/8	3/8	2	402-214-1	402-214W-1
		7/8	3/8	2-1/2	400-216-1	400-216W-1
		1-1/8	3/8	3	401-206-1	401-206W-1
15/32	15/32	1	1/2	3	400-218-1	400-218W-1
7/16	7/16	5/8	7/16	2-1/2	402-216-1	402-216W-1
		1	7/16	2-3/4	400-220-1	400-220W-1

V4 BALL ENDMILLS

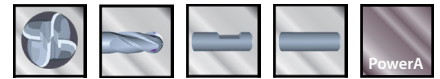

4 Flutes • Coated • With and without Flat

- High Performance A-Gr-SiV submicron grain carbide
- Unique variable helix design for faster speeds and feeds
- Quiet operation and better finish
- MAP certified quality

High Performance

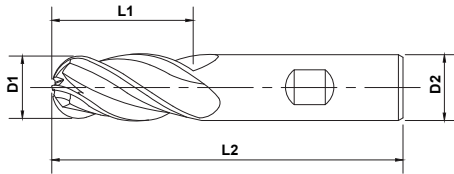

Length Key (K)

Standard Stub Long

Quick Ship Items



K	OD	LOC	SHK	OAL	PowerA	
	D1	L1	D2	L2	No Flat	With Flat
Standard	1/2	5/8	1/2	2-1/2	402-218-1	402-218W-1
		1	1/2	3	400-222-1	400-222W-1
		1-1/4	1/2	3	400-224-1	400-224W-1
		2	1/2	4	401-208-1	401-208W-1
Standard	9/16	1-1/8	9/16	3-1/2	400-226-1	400-226W-1
Stub	5/8	3/4	5/8	3	402-220-1	402-220W-1
		1-1/4	5/8	3-1/2	400-228-1	400-228W-1
		2-1/4	5/8	5	401-210-1	401-210W-1
Standard	3/4	1	3/4	3	402-224-1	402-224W-1
		7/8	3/4	3-1/2	402-222-1	402-222W-1
		1-1/2	3/4	4	400-230-1	400-230W-1
		1-5/8	3/4	4	400-232-1	400-232W-1
		2-1/4	3/4	5	401-212-1	401-212W-1
		3	3/4	6	401-214-1	401-214W-1
		4	3/4	6	401-216-1	401-216W-1
Long	1	1-1/2	1	4	400-234-1	400-234W-1
		2-1/4	1	5	401-218-1	401-218W-1
		3	1	6	401-220-1	401-220W-1
		4	1	7	401-222-1	401-222W-1

V4 CORNER RADIUS ENDMILLS

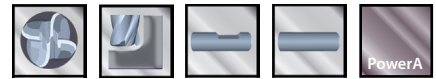

4 Flutes • Coated • With and without Flat

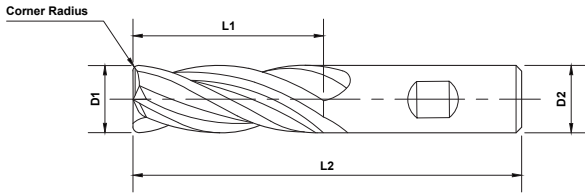

- High Performance A-Gr-SiV submicron grain carbide
- Unique variable helix design for faster speeds and feeds
- Quiet operation and better finish
- MAP certified quality

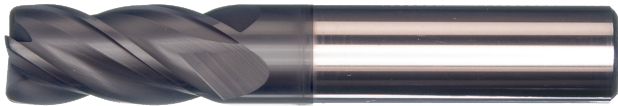

- Stub, Series 402, PowerA
- Standard, Series 400, PowerA
- Long, Series 401, PowerA

Length Key (K)

- Standard
- Stub
- Long

Quick Ship Items



K	OD	LOC	SHK	OAL	Radius	PowerA	
	D1	L1	D2	L2	R	No Flat	With Flat
1/8	1/8	1/4	1/8	1-1/2	.015	402-401-1	-
		1/4	1/8	1-1/2	.020	402-402-1	-
		1/4	1/8	1-1/2	.030	402-403-1	-
		1/4	1/8	1-1/2	.045	402-404-1	-
		3/8	1/8	1-1/2	.015	400-401-1	-
		3/8	1/8	1-1/2	.020	400-402-1	-
		3/8	1/8	1-1/2	.030	400-403-1	-
		3/8	1/8	1-1/2	.045	400-404-1	-
5/32	5/32	5/16	3/16	2	.015	402-411-1	-
		5/16	3/16	2	.020	402-412-1	-
		5/16	3/16	2	.030	402-413-1	-
		5/16	3/16	2	.045	402-414-1	-
3/16	3/16	3/8	3/16	2	.015	402-421-1	-
		3/8	3/16	2	.020	402-422-1	-
		3/8	3/16	2	.030	402-423-1	-
		3/8	3/16	2	.045	402-424-1	-
	3/16	7/16	3/16	2	.015	400-411-1	-
		7/16	3/16	2	.020	400-412-1	-
		7/16	3/16	2	.030	400-413-1	-
		7/16	3/16	2	.045	400-414-1	-
		3/4	3/16	2-1/2	.015	400-531-1	-
		3/4	3/16	2-1/2	.020	400-532-1	-
		3/4	3/16	2-1/2	.030	400-533-1	-
		3/4	3/16	2-1/2	.045	400-534-1	-
7/32	7/32	7/16	1/4	2	.015	402-431-1	-
		7/16	1/4	2	.020	402-432-1	-
		7/16	1/4	2	.030	402-433-1	-
		7/16	1/4	2	.045	402-434-1	-
		7/16	1/4	2	.060	402-435-1	-

V4 CORNER RADIUS ENDMILLS

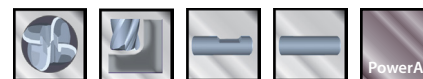

High Performance

4 Flutes • Coated • With and without Flat

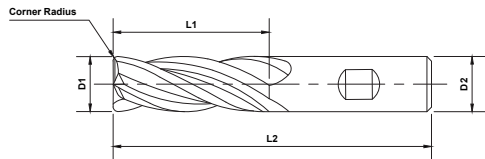

Length Key (K)

Standard Stub Long

Quick Ship Items



K	OD	LOC	SHK	OAL	Radius	PowerA					
	D1	L1	D2	L2	R	No Flat	With Flat				
1/4	3/8	1/4	1/4	2	.010	402-520-1	402-520W-1				
					.015	402-521-1	402-521W-1				
					.020	402-522-1	402-522W-1				
					.030	402-523-1	402-523W-1				
					.040	402-524-1	402-524W-1				
					.050	402-525-1	402-525W-1				
					1/2	1/4	1/4	2	.015	402-441-1	402-441W-1
									.020	402-442-1	402-442W-1
									.030	402-443-1	402-443W-1
									.045	402-444-1	402-444W-1
	.060	402-445-1	402-445W-1								
	5/8	1/4	1/4	2-1/2	.015	400-421-1	400-421W-1				
					.020	400-422-1	400-422W-1				
					.030	400-423-1	400-423W-1				
					.045	400-424-1	400-424W-1				
					.060	400-425-1	400-425W-1				
					3/4	1/4	1/4	2-1/2	.015	400-541-1	400-541W-1
									.020	400-542-1	400-542W-1
									.030	400-543-1	400-543W-1
									.045	400-544-1	400-544W-1
.060									400-545-1	400-545W-1	
1-1/8	1/4	1/4	3	.015	401-401-1	401-401W-1					
				.020	401-402-1	401-402W-1					
				.030	401-403-1	401-403W-1					
				.045	401-404-1	401-404W-1					
				.060	401-405-1	401-405W-1					
5/16	1/2	5/16	2	.015	402-451-1	402-451W-1					
				.020	402-452-1	402-452W-1					
				.030	402-453-1	402-453W-1					
				.045	402-454-1	402-454W-1					
				.060	402-455-1	402-455W-1					
	13/16	5/16	5/16	2-1/2	.015	400-431-1	400-431W-1				
					.020	400-432-1	400-432W-1				
					.030	400-433-1	400-433W-1				
					.045	400-434-1	400-434W-1				
					.060	400-435-1	400-435W-1				
					1-1/8	5/16	3	.020	401-412-1	401-412W-1	



V4 CORNER RADIUS ENDMILLS

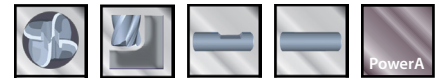

4 Flutes • Coated • With and without Flat

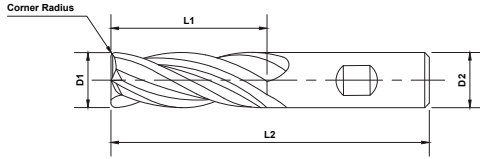

Length Key (K)



Quick Ship Items

K	OD	LOC	SHK	OAL	Radius	PowerA	
	D1	L1	D2	L2	R	No Flat	With Flat
3/8		5/8	3/8	2	.015	402-461-1	402-461W-1
		5/8	3/8	2	.020	402-462-1	402-462W-1
		5/8	3/8	2	.030	402-463-1	402-463W-1
		5/8	3/8	2	.045	402-464-1	402-464W-1
		5/8	3/8	2	.060	402-465-1	402-465W-1
		7/8	3/8	2-1/2	.015	400-441-1	400-441W-1
		7/8	3/8	2-1/2	.020	400-442-1	400-442W-1
		7/8	3/8	2-1/2	.030	400-443-1	400-443W-1
		7/8	3/8	2-1/2	.045	400-444-1	400-444W-1
		7/8	3/8	2-1/2	.060	400-445-1	400-445W-1
		1-1/8	3/8	3	.015	401-421-1	401-421W-1
		1-1/8	3/8	3	.020	401-422-1	401-422W-1
		1-1/8	3/8	3	.030	401-423-1	401-423W-1
		1-1/8	3/8	3	.045	401-424-1	401-424W-1
1-1/8	3/8	3	.060	401-425-1	401-425W-1		
7/16		5/8	7/16	2-1/2	.015	402-471-1	402-471W-1
		5/8	7/16	2-1/2	.020	402-472-1	402-472W-1
		5/8	7/16	2-1/2	.030	402-473-1	402-473W-1
		5/8	7/16	2-1/2	.045	402-474-1	402-474W-1
		5/8	7/16	2-1/2	.060	402-475-1	402-475W-1
		5/8	7/16	2-1/2	.090	402-476-1	402-476W-1
		1	7/16	2-3/4	.015	400-451-1	400-451W-1
		1	7/16	2-3/4	.020	400-452-1	400-452W-1
		1	7/16	2-3/4	.030	400-453-1	400-453W-1
		1	7/16	2-3/4	.045	400-454-1	400-454W-1
1	7/16	2-3/4	.060	400-456-1	400-456W-1		
1/2		5/8	1/2	2-1/2	.015	402-481-1	402-481W-1
		5/8	1/2	2-1/2	.020	402-482-1	402-482W-1
		5/8	1/2	2-1/2	.030	402-483-1	402-483W-1
		5/8	1/2	2-1/2	.045	402-484-1	402-484W-1
		5/8	1/2	2-1/2	.060	402-485-1	402-485W-1
		5/8	1/2	2-1/2	.090	402-486-1	402-486W-1
		1	1/2	3	.015	400-461-1	400-461W-1
		1	1/2	3	.020	400-462-1	400-462W-1
		1	1/2	3	.030	400-463-1	400-463W-1
		1	1/2	3	.045	400-464-1	400-464W-1
		1	1/2	3	.060	400-465-1	400-465W-1
		1	1/2	3	.090	400-466-1	400-466W-1
		1	1/2	3	.125	400-467-1	400-467W-1

V4 CORNER RADIUS ENDMILLS

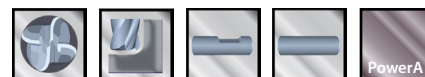

4 Flutes • Coated • With and without Flat

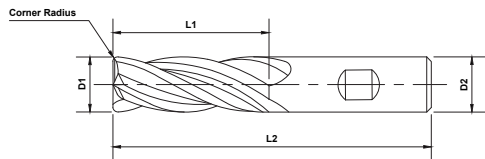

High Performance

Length Key (K)

Standard Stub Long

Quick Ship Items



K	OD	LOC	SHK	OAL	Radius	PowerA	
	D1	L1	D2	L2	R	No Flat	With Flat
1/2	1/2	1-1/4	1/2	3	.015	400-471-1	400-471W-1
		1-1/4	1/2	3	.020	400-472-1	400-472W-1
		1-1/4	1/2	3	.030	400-473-1	400-473W-1
		1-1/4	1/2	3	.045	400-474-1	400-474W-1
		1-1/4	1/2	3	.060	400-475-1	400-475W-1
		1-1/4	1/2	3	.090	400-476-1	400-476W-1
		1-1/4	1/2	3	.125	400-477-1	400-477W-1
		2	1/2	4	.015	401-431-1	401-431W-1
		2	1/2	4	.020	401-432-1	401-432W-1
		2	1/2	4	.030	401-433-1	401-433W-1
		2	1/2	4	.045	401-434-1	401-434W-1
		2	1/2	4	.060	401-435-1	401-435W-1
		2	1/2	4	.090	401-436-1	401-436W-1
		2	1/2	4	.125	401-437-1	401-437W-1
9/16	9/16	1-1/8	9/16	3-1/2	.015	400-481-1	400-481W-1
		1-1/8	9/16	3-1/2	.020	400-482-1	400-482W-1
		1-1/8	9/16	3-1/2	.030	400-483-1	400-483W-1
		1-1/8	9/16	3-1/2	.045	400-484-1	400-484W-1
		1-1/8	9/16	3-1/2	.060	400-485-1	400-485W-1
5/8	5/8	3/4	5/8	3	.015	402-491-1	402-491W-1
		3/4	5/8	3	.020	402-492-1	402-492W-1
		3/4	5/8	3	.030	402-493-1	402-493W-1
		3/4	5/8	3	.045	402-494-1	402-494W-1
		3/4	5/8	3	.060	402-495-1	402-495W-1
		3/4	5/8	3	.090	402-496-1	402-496W-1
		1-1/4	5/8	3-1/2	.015	400-491-1	400-491W-1
		1-1/4	5/8	3-1/2	.020	400-492-1	400-492W-1
		1-1/4	5/8	3-1/2	.030	400-493-1	400-493W-1
		1-1/4	5/8	3-1/2	.045	400-494-1	400-494W-1
		1-1/4	5/8	3-1/2	.060	400-495-1	400-495W-1
		2-1/4	5/8	5	.015	401-441-1	401-441W-1
		2-1/4	5/8	5	.020	401-442-1	401-442W-1
		2-1/4	5/8	5	.030	401-443-1	401-443W-1
		2-1/4	5/8	5	.045	401-444-1	401-444W-1
		2-1/4	5/8	5	.060	401-445-1	401-445W-1
		2-1/4	5/8	5	.090	401-446-1	401-446W-1

V4 CORNER RADIUS ENDMILLS

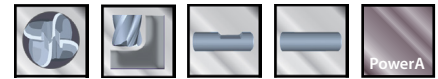

4 Flutes • Coated • With and without Flat

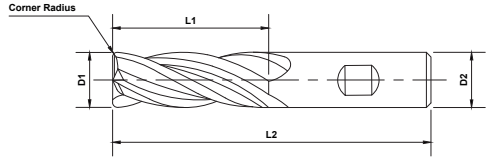

Length Key (K)



Quick Ship Items

K	OD	LOC	SHK	OAL	Radius	PowerA	
	D1	L1	D2	L2	R	No Flat	With Flat
Standard	3/4	1	3/4	3	.015	402-501-1	402-501W-1
		1	3/4	3	.020	402-502-1	402-502W-1
		1	3/4	3	.030	402-503-1	402-503W-1
		1	3/4	3	.045	402-504-1	402-504W-1
		1	3/4	3	.060	402-505-1	402-505W-1
		1	3/4	3	.090	402-506-1	402-506W-1
		7/8	3/4	3-1/2	.015	402-511-1	402-511W-1
		7/8	3/4	3-1/2	.020	402-512-1	402-512W-1
		7/8	3/4	3-1/2	.030	402-513-1	402-513W-1
		7/8	3/4	3-1/2	.045	402-514-1	402-514W-1
		7/8	3/4	3-1/2	.060	402-515-1	402-515W-1
		7/8	3/4	3-1/2	.090	402-516-1	402-516W-1
		1-1/2	3/4	4	.015	400-501-1	400-501W-1
		1-1/2	3/4	4	.020	400-502-1	400-502W-1
		1-1/2	3/4	4	.030	400-503-1	400-503W-1
		1-1/2	3/4	4	.045	400-504-1	400-504W-1
		1-1/2	3/4	4	.060	400-505-1	400-505W-1
		1-1/2	3/4	4	.090	400-506-1	400-506W-1
		1-1/2	3/4	4	.125	400-507-1	400-507W-1
		1-5/8	3/4	4	.015	400-511-1	400-511W-1
		1-5/8	3/4	4	.020	400-512-1	400-512W-1
		1-5/8	3/4	4	.030	400-513-1	400-513W-1
		1-5/8	3/4	4	.045	400-514-1	400-514W-1
		1-5/8	3/4	4	.060	400-515-1	400-515W-1
		1-5/8	3/4	4	.090	400-516-1	400-516W-1
		2-1/4	3/4	5	.015	401-451-1	401-451W-1
		2-1/4	3/4	5	.020	401-452-1	401-452W-1
		2-1/4	3/4	5	.030	401-453-1	401-453W-1
		2-1/4	3/4	5	.060	401-455-1	401-455W-1
		2-1/4	3/4	5	.090	401-456-1	401-456W-1
		2-1/4	3/4	5	.125	401-457-1	401-457W-1
		3	3/4	6	.015	401-461-1	401-461W-1
		3	3/4	6	.020	401-462-1	401-462W-1
		3	3/4	6	.030	401-463-1	401-463W-1
		3	3/4	6	.045	401-464-1	401-464W-1
		3	3/4	6	.060	401-465-1	401-465W-1
3	3/4	6	.090	401-466-1	401-466W-1		
4	3/4	6	.015	401-471-1	401-471W-1		
4	3/4	6	.020	401-472-1	401-472W-1		
4	3/4	6	.030	401-473-1	401-473W-1		
4	3/4	6	.045	401-474-1	401-474W-1		
4	3/4	6	.060	401-475-1	401-475W-1		
4	3/4	6	.090	401-476-1	401-476W-1		

V4 CORNER RADIUS ENDMILLS

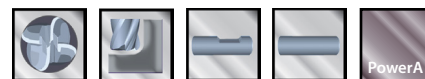

PowerA

4 Flutes • Coated • With and without Flat

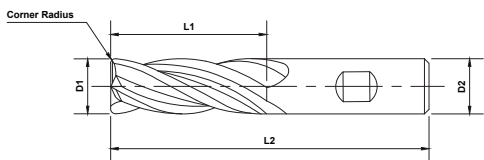

High Performance

Length Key (K)

Standard Stub Long

Quick Ship Items



K	OD	LOC	SHK	OAL	Radius	PowerA	
	D1	L1	D2	L2	R	No Flat	With Flat
1	1-1/2	1	4	.020	400-522-1	400-522W-1	
		1	4	.030	400-523-1	400-523W-1	
		1	4	.045	400-524-1	400-524W-1	
		1	4	.060	400-525-1	400-525W-1	
		1	4	.090	400-526-1	400-526W-1	
		2-1/4	1	5	.015	401-481-1	401-481W-1
			1	5	.020	401-482-1	401-482W-1
			1	5	.030	401-483-1	401-483W-1
			1	5	.045	401-484-1	401-484W-1
			1	5	.060	401-485-1	401-485W-1
	2-1/4	1	5	.090	401-486-1	401-486W-1	
		3	1	6	.015	401-491-1	401-491W-1
			1	6	.020	401-492-1	401-492W-1
			1	6	.030	401-493-1	401-493W-1
			1	6	.045	401-494-1	401-494W-1
	1		6	.060	401-495-1	401-495W-1	
	3	1	6	.090	401-496-1	401-496W-1	
		4	1	7	.015	401-501-1	401-501W-1
			1	7	.020	401-502-1	401-502W-1
			1	7	.030	401-503-1	401-503W-1
1			7	.045	401-504-1	401-504W-1	
1	7		.060	401-505-1	401-505W-1		
4	1	7	.090	401-506-1	401-506W-1		

V5 SQUARE ENDMILLS

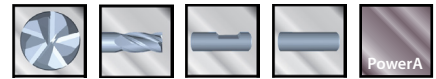

5 Flutes • Coated • With and without Flat

- High Performance A-Gr-SiV submicron grain carbide
- Unique variable helix design for faster speeds and feeds
- Quiet operation and better finish
- MAP certified quality

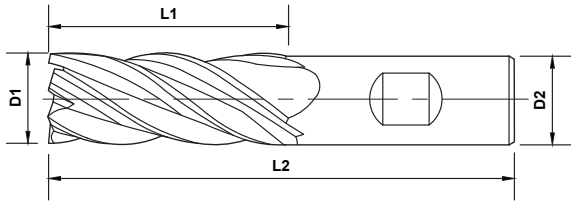

- Stub, Series 410, PowerA
- Standard, Series 408, PowerA
- Long, Series 409, PowerA



Length Key (K)

Standard Stub Long



K	OD	LOC	SHK	OAL	PowerA	
	D1	L1	D2	L2	No Flat	With Flat
5/16	5/16	1/2	5/16	2	410-012-1	410-012W-1
		13/16	5/16	2-1/2	408-008-1	408-008W-1
3/8	3/8	5/8	3/8	2	410-014-1	410-014W-1
		7/8	3/8	2-1/2	408-010-1	408-010W-1
		1-1/8	3/8	3	409-004-1	409-004W-1
7/16	7/16	5/8	7/16	2-1/2	410-016-1	410-016W-1
		1	7/16	2-3/4	408-012-1	408-012W-1
1/2	1/2	5/8	1/2	2-1/2	410-018-1	410-018W-1
		1	1/2	3	408-014-1	408-014W-1
		1-1/4	1/2	3	408-016-1	408-016W-1
		2	1/2	4	409-006-1	409-006W-1
9/16	9/16	1-1/8	9/16	3-1/2	408-018-1	408-018W-1
5/8	5/8	3/4	5/8	3	410-020-1	410-020W-1
		1-1/4	5/8	3-1/2	408-020-1	408-020W-1
		2-1/4	5/8	5	409-008-1	409-008W-1
3/4	3/4	7/8	3/4	3-1/2	410-024-1	410-024W-1
		1	3/4	3	410-022-1	410-022W-1
		1-5/8	3/4	4	408-022-1	408-022W-1
		1-1/2	3/4	4	408-024-1	408-024W-1
		2-1/4	3/4	5	409-010-1	409-010W-1
		3	3/4	6	409-012-1	409-012W-1
1	1	1-1/2	1	4	408-026-1	408-026W-1
		2-1/4	1	5	409-014-1	409-014W-1
		3	1	6	409-016-1	409-016W-1
		4	1	7	409-018-1	409-018W-1

V5 BALL ENDMILLS

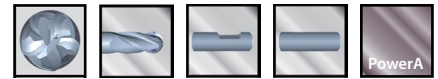

5 Flutes • Coated • With and without Flat

- High Performance A-Gr-SiV submicron grain carbide
- Unique variable helix design for faster speeds and feeds
- Quiet operation and better finish
- MAP certified quality

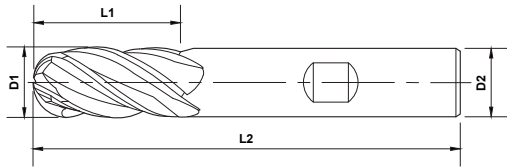

- Stub, Series 410, PowerA
- Standard, Series 408, PowerA
- Long, Series 409, PowerA

High Performance

Length Key (K)

■ Standard ■ Stub ■ Long



K	OD	LOC	SHK	OAL	PowerA	
	D1	L1	D2	L2	No Flat	With Flat
■	5/16	1/2	5/16	2	410-212-1	410-212W-1
		13/16	5/16	2-1/2	408-208-1	408-208W-1
■	3/8	5/8	3/8	2	410-214-1	410-214W-1
		7/8	3/8	2-1/2	408-210-1	408-210W-1
■	7/16	1-1/8	3/8	3	409-204-1	409-204W-1
		5/8	7/16	2-1/2	410-216-1	410-216W-1
■	1/2	1	7/16	2-3/4	408-212-1	408-212W-1
		5/8	1/2	2-1/2	410-218-1	410-218W-1
■	9/16	1	1/2	3	408-214-1	408-214W-1
		1-1/4	1/2	3	408-216-1	408-216W-1
■	5/8	2	1/2	4	409-206-1	409-206W-1
		1-1/8	9/16	3-1/2	408-218-1	408-218W-1
■	3/4	3/4	5/8	3	410-220-1	410-220W-1
		1-1/4	5/8	3-1/2	408-220-1	408-220W-1
■	1	2-1/4	5/8	5	409-208-1	409-208W-1
		1	3/4	3	410-222-1	410-222W-1
■	3/4	7/8	3/4	3-1/2	410-224-1	410-224W-1
		1-1/2	3/4	4	408-222-1	408-222W-1
■	1	1-5/8	3/4	4	408-224-1	408-224W-1
		2-1/4	3/4	5	409-210-1	409-210W-1
■	3/4	3	3/4	6	409-212-1	409-212W-1
		1-1/2	1	4	408-226-1	408-226W-1
■	1	2-1/4	1	5	409-214-1	409-214W-1
		3	1	6	409-216-1	409-216W-1
■	1	4	1	7	409-218-1	409-218W-1

V5 CORNER RADIUS ENDMILLS

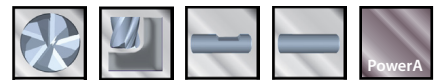

5 Flutes • Coated • With and without Flat

- High Performance A-Gr-SiV submicron grain carbide
- Unique variable helix design for faster speeds and feeds
- Quiet operation and better finish
- MAP certified quality

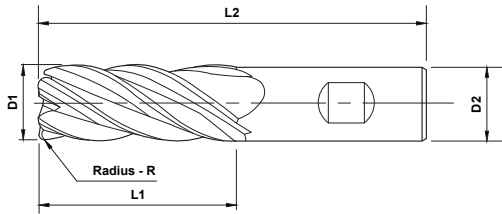

- Stub, Series 410, PowerA
- Standard, Series 408, PowerA
- Long, Series 409, PowerA

Length Key (K)

- Standard
- Stub
- Long

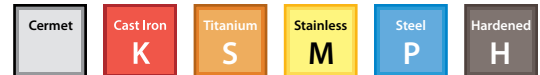

K	OD	LOC	SHK	OAL	Radius	PowerA	
	D1	L1	D2	L2	R	No Flat	With Flat
5/16		1/2	5/16	2	.015	410-451-1	410-451W-1
		1/2	5/16	2	.020	410-452-1	410-452W-1
		1/2	5/16	2	.030	410-453-1	410-453W-1
		1/2	5/16	2	.045	410-454-1	410-454W-1
		1/2	5/16	2	.060	410-455-1	410-455W-1
		13/16	5/16	2-1/2	.015	408-431-1	408-431W-1
		13/16	5/16	2-1/2	.020	408-432-1	408-432W-1
		13/16	5/16	2-1/2	.030	408-433-1	408-433W-1
		13/16	5/16	2-1/2	.045	408-434-1	408-434W-1
		13/16	5/16	2-1/2	.060	408-435-1	408-435W-1
3/8		5/8	3/8	2	.015	410-461-1	410-461W-1
		5/8	3/8	2	.020	410-462-1	410-462W-1
		5/8	3/8	2	.030	410-463-1	410-463W-1
		5/8	3/8	2	.045	410-464-1	410-464W-1
		5/8	3/8	2	.060	410-465-1	410-465W-1
		7/8	3/8	2-1/2	.015	408-441-1	408-441W-1
		7/8	3/8	2-1/2	.020	408-442-1	408-442W-1
7/8	3/8	2-1/2	.030	408-443-1	408-443W-1		

V5 CORNER RADIUS ENDMILLS

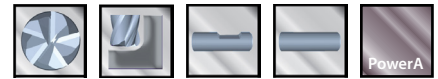

5 Flutes • Coated • With and without Flat

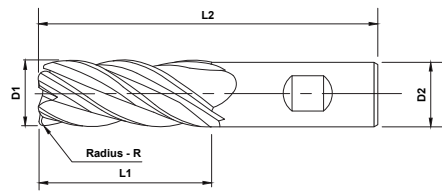

- High Performance A-Gr-SiV submicron grain carbide
- Unique variable helix design for faster speeds and feeds
- Quiet operation and better finish
- MAP certified quality



High Performance

Length Key (K)

Standard Stub Long

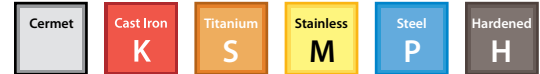

K	OD	LOC	SHK	OAL	Radius	PowerA	
	D1	L1	D2	L2	R	No Flat	With Flat
Standard	3/8	7/8	3/8	2-1/2	.045	408-444-1	408-444W-1
		7/8	3/8	2-1/2	.060	408-445-1	408-445W-1
		1-1/8	3/8	3	.015	409-411-1	409-411W-1
		1-1/8	3/8	3	.020	409-412-1	409-412W-1
		1-1/8	3/8	3	.030	409-413-1	409-413W-1
		1-1/8	3/8	3	.045	409-414-1	409-414W-1
		1-1/8	3/8	3	.060	409-415-1	409-415W-1
Stub	7/16	5/8	7/16	2-1/2	.015	410-471-1	410-471W-1
		5/8	7/16	2-1/2	.020	410-472-1	410-472W-1
		5/8	7/16	2-1/2	.030	410-473-1	410-473W-1
		5/8	7/16	2-1/2	.045	410-474-1	410-474W-1
		5/8	7/16	2-1/2	.060	410-475-1	410-475W-1
		5/8	7/16	2-1/2	.090	410-476-1	410-476W-1
		1	7/16	2-3/4	.015	408-451-1	408-451W-1
		1	7/16	2-3/4	.020	408-452-1	408-452W-1
		1	7/16	2-3/4	.030	408-453-1	408-453W-1
		1	7/16	2-3/4	.045	408-454-1	408-454W-1
		1	7/16	2-3/4	.060	408-455-1	408-455W-1
		1	7/16	2-3/4	.090	408-456-1	408-456W-1
		Long	1/2	5/8	1/2	2-1/2	.015
5/8	1/2			2-1/2	.020	410-482-1	410-482W-1
5/8	1/2			2-1/2	.030	410-483-1	410-483W-1
5/8	1/2			2-1/2	.045	410-484-1	410-484W-1
5/8	1/2			2-1/2	.060	410-485-1	410-485W-1
5/8	1/2			2-1/2	.090	410-486-1	410-486W-1
1	1/2			3	.015	408-461-1	408-461W-1
1	1/2			3	.020	408-462-1	408-462W-1
1	1/2			3	.030	408-463-1	408-463W-1
1	1/2			3	.045	408-464-1	408-464W-1
1	1/2			3	.060	408-465-1	408-465W-1
1	1/2			3	.090	408-466-1	408-466W-1

V5 CORNER RADIUS ENDMILLS



5 Flutes • Coated • With and without Flat

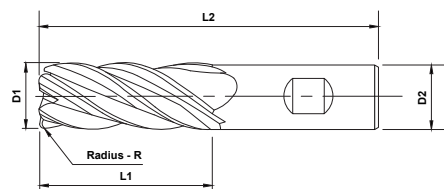

- High Performance A-Gr-SiV submicron grain carbide
- Unique variable helix design for faster speeds and feeds
- Quiet operation and better finish
- MAP certified quality



Length Key (K)

Standard Stub Long



K	OD	LOC	SHK	OAL	Radius	PowerA		
	D1	L1	D2	L2	R	No Flat	With Flat	
Standard	1/2	1-1/4	1/2	3	.015	408-471-1	408-471W-1	
		1-1/4	1/2	3	.020	408-472-1	408-472W-1	
		1-1/4	1/2	3	.030	408-473-1	408-473W-1	
		1-1/4	1/2	3	.045	408-474-1	408-474W-1	
		1-1/4	1/2	3	.060	408-475-1	408-475W-1	
		1-1/4	1/2	3	.090	408-476-1	408-476W-1	
	Stub	1/2	2	1/2	4	.015	409-421-1	409-421W-1
			2	1/2	4	.020	409-422-1	409-422W-1
			2	1/2	4	.030	409-423-1	409-423W-1
			2	1/2	4	.045	409-424-1	409-424W-1
			2	1/2	4	.060	409-425-1	409-425W-1
			2	1/2	4	.090	409-426-1	409-426W-1
Standard	9/16	1-1/8	9/16	3-1/2	.015	408-481-1	408-481W-1	
		1-1/8	9/16	3-1/2	.020	408-482-1	408-482W-1	
		1-1/8	9/16	3-1/2	.030	408-483-1	408-483W-1	
		1-1/8	9/16	3-1/2	.045	408-484-1	408-484W-1	
		1-1/8	9/16	3-1/2	.060	408-485-1	408-485W-1	
		1-1/8	9/16	3-1/2	.090	408-486-1	408-486W-1	
Stub	5/8	3/4	5/8	3	.015	410-491-1	410-491W-1	
		3/4	5/8	3	.020	410-492-1	410-492W-1	
		3/4	5/8	3	.030	410-493-1	410-493W-1	
		3/4	5/8	3	.045	410-494-1	410-494W-1	
		3/4	5/8	3	.060	410-495-1	410-495W-1	
		3/4	5/8	3	.090	410-496-1	410-496W-1	
	Standard	5/8	1-1/4	5/8	3-1/2	.015	408-491-1	408-491W-1
			1-1/4	5/8	3-1/2	.020	408-492-1	408-492W-1
			1-1/4	5/8	3-1/2	.030	408-493-1	408-493W-1
			1-1/4	5/8	3-1/2	.045	408-494-1	408-494W-1
			1-1/4	5/8	3-1/2	.060	408-495-1	408-495W-1
			1-1/4	5/8	3-1/2	.090	408-496-1	408-496W-1
Stub	5/8	2-1/4	5/8	5	.015	409-431-1	409-431W-1	
		2-1/4	5/8	5	.020	409-432-1	409-432W-1	

V5 CORNER RADIUS ENDMILLS

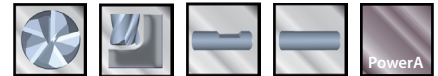

5 Flutes • Coated • With and without Flat

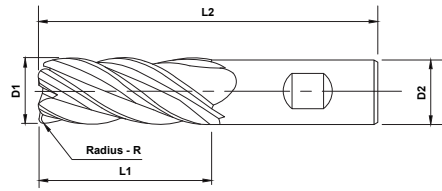

- High Performance A-Gr-SiV submicron grain carbide
- Unique variable helix design for faster speeds and feeds
- Quiet operation and better finish
- MAP certified quality



High Performance

Length Key (K)

Standard Stub Long



K	OD	LOC	SHK	OAL	Radius	PowerA	
	D1	L1	D2	L2	R	No Flat	With Flat
5/8	5/8	2-1/4	5/8	5	.030	409-433-1	409-433W-1
		2-1/4	5/8	5	.045	409-434-1	409-434W-1
		2-1/4	5/8	5	.060	409-435-1	409-435W-1
		2-1/4	5/8	5	.090	409-436-1	409-436W-1
3/4	3/4	1	3/4	3	.015	410-501-1	410-501W-1
		1	3/4	3	.020	410-502-1	410-502W-1
		1	3/4	3	.030	410-503-1	410-503W-1
		1	3/4	3	.045	410-504-1	410-504W-1
		1	3/4	3	.060	410-505-1	410-505W-1
		1	3/4	3	.090	410-506-1	410-506W-1
		7/8	3/4	3-1/2	.015	410-511-1	410-511W-1
		7/8	3/4	3-1/2	.020	410-512-1	410-512W-1
		7/8	3/4	3-1/2	.030	410-513-1	410-513W-1
		7/8	3/4	3-1/2	.045	410-514-1	410-514W-1
		7/8	3/4	3-1/2	.060	410-515-1	410-515W-1
		7/8	3/4	3-1/2	.090	410-516-1	410-516W-1
		1-1/2	3/4	4	.015	408-501-1	408-501W-1
		1-1/2	3/4	4	.020	408-502-1	408-502W-1
		1-1/2	3/4	4	.030	408-503-1	408-503W-1
		1-1/2	3/4	4	.045	408-504-1	408-504W-1
		1-1/2	3/4	4	.060	408-505-1	408-505W-1
		1-1/2	3/4	4	.090	408-506-1	408-506W-1
		1-5/8	3/4	4	.015	408-511-1	408-511W-1
		1-5/8	3/4	4	.020	408-512-1	408-512W-1
1-5/8	3/4	4	.030	408-513-1	408-513W-1		
1-5/8	3/4	4	.045	408-514-1	408-514W-1		
1-5/8	3/4	4	.060	408-515-1	408-515W-1		
1-5/8	3/4	4	.090	408-516-1	408-516W-1		
2-1/4	3/4	5	.015	409-441-1	409-441W-1		
2-1/4	3/4	5	.020	409-442-1	409-442W-1		
2-1/4	3/4	5	.030	409-443-1	409-443W-1		
2-1/4	3/4	5	.045	409-444-1	409-444W-1		

V5 CORNER RADIUS ENDMILLS

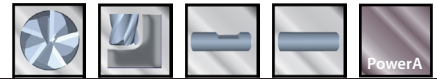

5 Flutes • Coated • With and without Flat

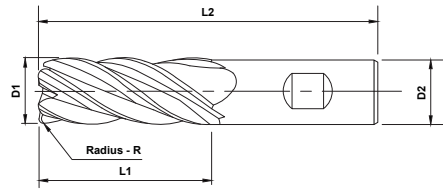

- High Performance A-Gr-SiV submicron grain carbide
- Unique variable helix design for faster speeds and feeds
- Quiet operation and better finish
- MAP certified quality



Length Key (K)

Standard Stub Long

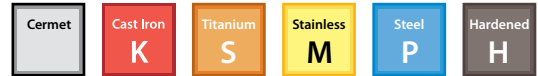

K	OD	LOC	SHK	OAL	Radius	PowerA	
	D1	L1	D2	L2	R	No Flat	With Flat
3/4	3/4	2-1/4	3/4	5	.060	409-445-1	409-445W-1
		2-1/4	3/4	5	.090	409-446-1	409-446W-1
		3	3/4	6	.015	409-451-1	409-451W-1
		3	3/4	6	.020	409-452-1	409-452W-1
		3	3/4	6	.030	409-453-1	409-453W-1
		3	3/4	6	.045	409-454-1	409-454W-1
		3	3/4	6	.060	409-455-1	409-455W-1
		3	3/4	6	.090	409-456-1	409-456W-1
1	1	1-1/2	1	4	.015	408-521-1	408-521W-1
		1-1/2	1	4	.020	408-522-1	408-522W-1
		1-1/2	1	4	.030	408-523-1	408-523W-1
		1-1/2	1	4	.045	408-524-1	408-524W-1
		1-1/2	1	4	.060	408-525-1	408-525W-1
		1-1/2	1	4	.090	408-526-1	408-526W-1
		2-1/4	1	5	.015	409-461-1	409-461W-1
		2-1/4	1	5	.020	409-462-1	409-462W-1
		2-1/4	1	5	.030	409-463-1	409-463W-1
		2-1/4	1	5	.045	409-464-1	409-464W-1
		2-1/4	1	5	.060	409-465-1	409-465W-1
		2-1/4	1	5	.090	409-466-1	409-466W-1
		3	1	6	.015	409-471-1	409-471W-1
		3	1	6	.020	409-472-1	409-472W-1
		3	1	6	.030	409-473-1	409-473W-1
		3	1	6	.045	409-474-1	409-474W-1
		3	1	6	.060	409-475-1	409-475W-1
		3	1	6	.090	409-476-1	409-476W-1
		4	1	7	.015	409-481-1	409-481W-1
		4	1	7	.020	409-482-1	409-482W-1
		4	1	7	.030	409-483-1	409-483W-1
		4	1	7	.045	409-484-1	409-484W-1
		4	1	7	.060	409-485-1	409-485W-1
		4	1	7	.090	409-486-1	409-486W-1

HY5 SQUARE ENDMILLS

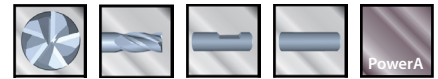

5 Flutes • Coated • With and without Flat • 45° Helix

- High Performance A-Gr-SiV submicron grain carbide
- Unique 5 flute design for faster speeds and feeds
- MAP certified quality

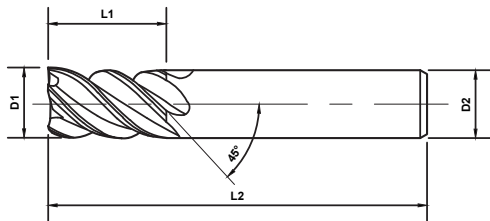

- Stub, Series 447, PowerA
- Standard, Series 445, PowerA
- Long, Series 401, PowerA

Length Key (K)

Standard Stub Long

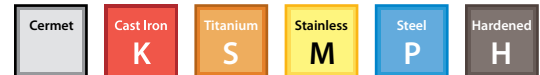

K	OD	LOC	SHK	OAL	PowerA	
					No Flat	With Flat
1/8	1/8	1/4	1/8	1-1/2	447-004-1	-
		1/2	1/8	1-1/2	445-002-1	-
5/32	5/32	5/16	3/16	2	447-002-1	-
		7/16	3/16	2	445-004-1	-
3/16	3/16	3/8	3/16	2	447-006-1	-
		7/16	3/16	2	445-006-1	-
7/32	7/32	7/16	1/4	2	447-008-1	-
		7/16	1/4	2-1/2	445-008-1	-
1/4	1/4	1/2	1/4	2	447-010-1	447-010W-1
		3/4	1/4	2-1/2	445-010-1	445-010W-1
		1-1/8	1/4	3	446-002-1	446-002W-1
5/16	5/16	1/2	5/16	2	447-012-1	447-012W-1
		13/16	5/16	2-1/2	445-012-1	445-012W-1
		1-1/8	5/16	3	446-004-1	446-004W-1
11/32	11/32	13/16	3/8	2-1/2	445-014-1	445-014W-1
		5/8	3/8	2	447-014-1	447-014W-1
3/8	3/8	7/8	3/8	2-1/2	445-016-1	445-016W-1

High Performance

HY5 SQUARE ENDMILLS

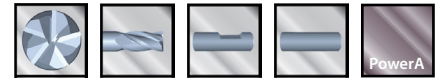

5 Flutes • Coated • With and without Flat • 45° Helix

- High Performance A-Gr-SiV submicron grain carbide
- Unique 5 flute design for faster speeds and feeds
- MAP certified quality

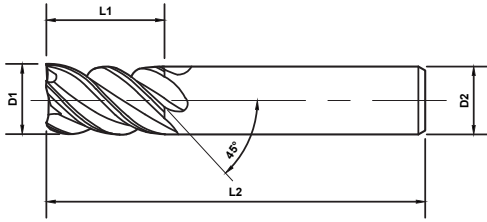

Length Key (K)

Standard Stub Long



K	OD	LOC	SHK	OAL	PowerA	
					No Flat	With Flat
Standard	3/8	1-1/8	3/8	3	446-006-1	446-006W-1
		1	1/2	3	445-018-1	445-018W-1
Stub	7/16	5/8	7/16	2-1/2	447-016-1	447-016W-1
		1	7/16	2-3/4	445-020-1	445-020W-1
Standard	1/2	5/8	1/2	2-1/2	447-018-1	447-018W-1
		1	1/2	3	445-022-1	445-022W-1
		1-1/4	1/2	3	445-024-1	445-024W-1
		2	1/2	4	446-008-1	446-008W-1
Standard	9/16	1-1/8	9/16	3-1/2	445-026-1	445-026W-1
		3/4	5/8	3	447-020-1	447-020W-1
Stub	5/8	1-1/4	5/8	3-1/2	445-028-1	445-028W-1
		2-1/4	5/8	5	446-010-1	446-010W-1
		1	3/4	3	447-024-1	447-024W-1
Standard	3/4	7/8	3/4	3-1/2	447-022-1	447-022W-1
		1-1/2	3/4	4	445-030-1	445-030W-1
		1-5/8	3/4	4	445-032-1	445-032W-1
		2-1/4	3/4	5	446-012-1	446-012W-1
		3	3/4	6	446-014-1	446-014W-1
		4	3/4	6	446-016-1	446-016W-1
Long	1	1-1/2	1	4	445-034-1	445-034W-1
		2-1/4	1	5	446-018-1	446-018W-1
		3	1	6	446-020-1	446-020W-1
		4	1	7	446-022-1	446-022W-1

HY5 CORNER RADIUS ENDMILLS

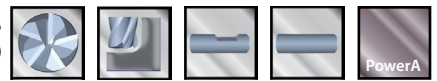

5 Flutes • Coated • With and without Flat

- High Performance A-Gr-SiV submicron grain carbide
- Unique 5 flute design for faster speeds and feeds
- MAP certified quality

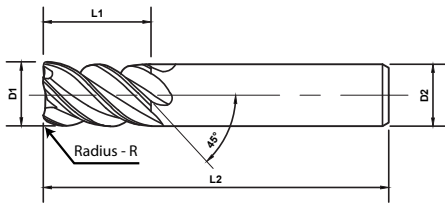

- Standard, Series 447, PowerA
- Standard, Series 445, PowerA
- Long, Series 446, PowerA

High Performance

Length Key (K)

Standard Stub Long



K	OD	LOC	SHK	OAL	Radius	PowerA	
	D1	L1	D2	L2	R	No Flat	With Flat
1/8	1/8	1/4	1/8	1-1/2	.015	447-401-1	-
		1/4	1/8	1-1/2	.020	447-402-1	-
		1/4	1/8	1-1/2	.030	447-403-1	-
		1/4	1/8	1-1/2	.045	447-404-1	-
		1/2	1/8	1-1/2	.015	445-401-1	-
		1/2	1/8	1-1/2	.020	445-402-1	-
		1/2	1/8	1-1/2	.030	445-403-1	-
		1/2	1/8	1-1/2	.045	445-404-1	-
5/32	5/32	5/16	3/16	2	.015	447-411-1	-
		5/16	3/16	2	.020	447-412-1	-
		5/16	3/16	2	.030	447-413-1	-
		5/16	3/16	2	.045	447-414-1	-
3/16	3/16	3/8	3/16	2	.015	447-421-1	-
		3/8	3/16	2	.020	447-422-1	-
		3/8	3/16	2	.030	447-423-1	-
		3/8	3/16	2	.045	447-424-1	-
		7/16	3/16	2	.015	445-411-1	-
		7/16	3/16	2	.020	445-412-1	-
		7/16	3/16	2	.030	445-413-1	-
		7/16	3/16	2	.045	445-414-1	-

HY5 CORNER RADIUS ENDMILLS

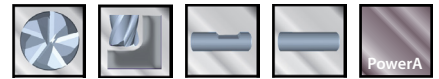

5 Flutes • Coated • With and without Flat



- High Performance A-Gr-SiV submicron grain carbide
- Unique 5 flute design for faster speeds and feeds
- MAP certified quality

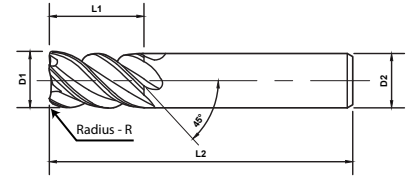

Length Key (K)



K	OD	LOC	SHK	OAL	Radius	PowerA		
	D1	L1	D2	L2	R	No Flat	With Flat	
Stub	7/32	7/16	1/4	2	.015	447-431-1	-	
		7/16	1/4	2	.020	447-432-1	-	
		7/16	1/4	2	.030	447-433-1	-	
		7/16	1/4	2	.045	447-434-1	-	
		7/16	1/4	2	.060	447-435-1	-	
	Standard	1/4	1/2	1/4	2	.010	447-440-1	447-440W-1
			1/2	1/4	2	.015	447-441-1	447-441W-1
			1/2	1/4	2	.020	447-442-1	447-442W-1
			1/2	1/4	2	.030	447-443-1	447-443W-1
			1/2	1/4	2	.045	447-444-1	447-444W-1
			1/2	1/4	2	.060	447-445-1	447-445W-1
			3/4	1/4	2-1/2	.015	445-421-1	445-421W-1
			3/4	1/4	2-1/2	.020	445-422-1	445-422W-1
			3/4	1/4	2-1/2	.030	445-423-1	445-423W-1
			3/4	1/4	2-1/2	.045	445-424-1	445-424W-1
Long	1/4	1-1/8	1/4	3	.015	446-401-1	446-401W-1	
		1-1/8	1/4	3	.020	446-402-1	446-402W-1	
		1-1/8	1/4	3	.030	446-403-1	446-403W-1	
		1-1/8	1/4	3	.045	446-404-1	446-404W-1	
		1-1/8	1/4	3	.060	446-405-1	446-405W-1	
Stub	5/16	1/2	5/16	2	.015	447-451-1	447-451W-1	
		1/2	5/16	2	.020	447-452-1	447-452W-1	
		1/2	5/16	2	.030	447-453-1	447-453W-1	
		1/2	5/16	2	.045	447-454-1	447-454W-1	
		1/2	5/16	2	.060	447-455-1	447-455W-1	
		13/16	5/16	2-1/2	.015	445-431-1	445-431W-1	
		13/16	5/16	2-1/2	.020	445-432-1	445-432W-1	
		13/16	5/16	2-1/2	.030	445-433-1	445-433W-1	
		13/16	5/16	2-1/2	.045	445-434-1	445-434W-1	
		13/16	5/16	2-1/2	.060	445-435-1	445-435W-1	
		1-1/8	5/16	3	.020	446-412-1	446-412W-1	

HY5 CORNER RADIUS ENDMILLS

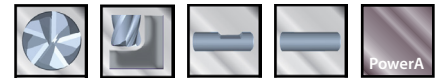

5 Flutes • Coated • With and without Flat



- High Performance A-Gr-SiV submicron grain carbide
- Unique 5 flute design for faster speeds and feeds
- MAP certified quality

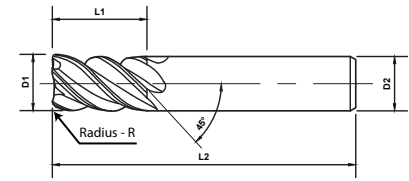

High Performance

Length Key (K)

Standard
 Stub
 Long



K	OD	LOC	SHK	OAL	Radius	PowerA	
						No Flat	With Flat
Standard	3/8	5/8	3/8	2	.015	447-461-1	447-461W-1
		5/8	3/8	2	.020	447-462-1	447-462W-1
		5/8	3/8	2	.030	447-463-1	447-463W-1
		5/8	3/8	2	.045	447-464-1	447-464W-1
		5/8	3/8	2	.060	447-465-1	447-465W-1
		7/8	3/8	2-1/2	.015	445-441-1	445-441W-1
		7/8	3/8	2-1/2	.020	445-442-1	445-442W-1
		7/8	3/8	2-1/2	.030	445-443-1	445-443W-1
		7/8	3/8	2-1/2	.045	445-444-1	445-444W-1
		7/8	3/8	2-1/2	.060	445-445-1	445-445W-1
		1-1/8	3/8	3	.015	446-421-1	446-421W-1
		1-1/8	3/8	3	.020	446-422-1	446-422W-1
		1-1/8	3/8	3	.030	446-423-1	446-423W-1
		1-1/8	3/8	3	.045	446-424-1	446-424W-1
		1-1/8	3/8	3	.060	446-425-1	446-425W-1
Stub	7/16	5/8	7/16	2-1/2	.015	447-471-1	447-471W-1
		5/8	7/16	2-1/2	.020	447-472-1	447-472W-1
		5/8	7/16	2-1/2	.030	447-473-1	447-473W-1
		5/8	7/16	2-1/2	.045	447-474-1	447-474W-1
		5/8	7/16	2-1/2	.060	447-475-1	447-475W-1
		5/8	7/16	2-1/2	.090	447-476-1	447-476W-1
		1	7/16	2-3/4	.015	445-451-1	445-451W-1
		1	7/16	2-3/4	.020	445-452-1	445-452W-1
		1	7/16	2-3/4	.030	445-453-1	445-453W-1
		1	7/16	2-3/4	.060	445-456-1	445-456W-1
Long	1/2	5/8	1/2	2-1/2	.015	447-481-1	447-481W-1
		5/8	1/2	2-1/2	.020	447-482-1	447-482W-1
		5/8	1/2	2-1/2	.030	447-483-1	447-483W-1
		5/8	1/2	2-1/2	.045	447-484-1	447-484W-1
		5/8	1/2	2-1/2	.060	447-485-1	447-485W-1
		5/8	1/2	2-1/2	.090	447-486-1	447-486W-1



HY5 CORNER RADIUS ENDMILLS

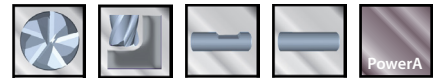

5 Flutes • Coated • With and without Flat

- High Performance A-Gr-SIV submicron grain carbide
- Unique 5 flute design for faster speeds and feeds
- MAP certified quality

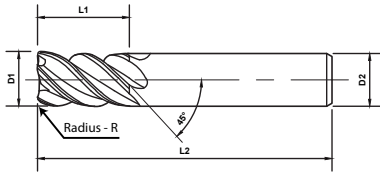

Length Key (K)

Standard Stub Long



K	OD	LOC	SHK	OAL	Radius	PowerA	
	D1	L1	D2	L2	R	No Flat	With Flat
Standard	1/2	1	1/2	3	.015	445-461-1	445-461W-1
		1	1/2	3	.020	445-462-1	445-462W-1
		1	1/2	3	.030	445-463-1	445-463W-1
		1	1/2	3	.045	445-464-1	445-464W-1
		1	1/2	3	.060	445-465-1	445-465W-1
		1	1/2	3	.090	445-466-1	445-466W-1
		1	1/2	3	.125	445-467-1	445-467W-1
		1-1/4	1/2	3	.015	445-471-1	445-471W-1
		1-1/4	1/2	3	.020	445-472-1	445-472W-1
		1-1/4	1/2	3	.030	445-473-1	445-473W-1
		1-1/4	1/2	3	.045	445-474-1	445-474W-1
		1-1/4	1/2	3	.060	445-475-1	445-475W-1
		1-1/4	1/2	3	.090	445-476-1	445-476W-1
		1-1/4	1/2	3	.125	445-477-1	445-477W-1
		2	1/2	4	.015	446-431-1	446-431W-1
		2	1/2	4	.020	446-432-1	446-432W-1
2	1/2	4	.030	446-433-1	446-433W-1		
2	1/2	4	.045	446-434-1	446-434W-1		
2	1/2	4	.060	446-435-1	446-435W-1		
2	1/2	4	.090	446-436-1	446-436W-1		
2	1/2	4	.125	446-437-1	446-437W-1		
Standard	9/16	1-1/8	9/16	3-1/2	.015	445-481-1	445-481W-1
		1-1/8	9/16	3-1/2	.020	445-482-1	445-482W-1
		1-1/8	9/16	3-1/2	.030	445-483-1	445-483W-1
		1-1/8	9/16	3-1/2	.045	445-484-1	445-484W-1
		1-1/8	9/16	3-1/2	.060	445-485-1	445-485W-1
Stub	5/8	3/4	5/8	3	.015	447-491-1	447-491W-1
		3/4	5/8	3	.020	447-492-1	447-492W-1
		3/4	5/8	3	.030	447-493-1	447-493W-1
		3/4	5/8	3	.045	447-494-1	447-494W-1
		3/4	5/8	3	.060	447-495-1	447-495W-1
		3/4	5/8	3	.090	447-496-1	447-496W-1
		1-1/4	5/8	3-1/2	.015	445-491-1	445-491W-1
		1-1/4	5/8	3-1/2	.020	445-492-1	445-492W-1
		1-1/4	5/8	3-1/2	.030	445-493-1	445-493W-1

HY5 CORNER RADIUS ENDMILLS

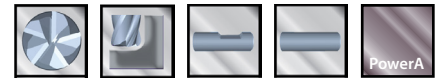

5 Flutes • Coated • With and without Flat

- High Performance A-Gr-SiV submicron grain carbide
- Unique 5 flute design for faster speeds and feeds
- MAP certified quality

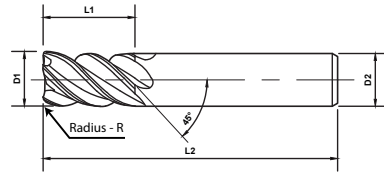

Length Key (K)

Standard Stub Long



K	OD	LOC	SHK	OAL	Radius	PowerA	
	D1	L1	D2	L2	R	No Flat	With Flat
Standard	5/8	1-1/4	5/8	3-1/2	.045	445-494-1	445-494W-1
		1-1/4	5/8	3-1/2	.060	445-495-1	445-495W-1
		2-1/4	5/8	5	.015	446-441-1	446-441W-1
		2-1/4	5/8	5	.020	446-442-1	446-442W-1
		2-1/4	5/8	5	.030	446-443-1	446-443W-1
		2-1/4	5/8	5	.045	446-444-1	446-444W-1
		2-1/4	5/8	5	.060	446-445-1	446-445W-1
Stub	3/4	1	3/4	3	.015	447-501-1	447-501W-1
		1	3/4	3	.020	447-502-1	447-502W-1
		1	3/4	3	.030	447-503-1	447-503W-1
		1	3/4	3	.045	447-504-1	447-504W-1
		1	3/4	3	.060	447-505-1	447-505W-1
		1	3/4	3	.090	447-506-1	447-506W-1
		7/8	3/4	3-1/2	.015	447-511-1	447-511W-1
		7/8	3/4	3-1/2	.020	447-512-1	447-512W-1
		7/8	3/4	3-1/2	.030	447-513-1	447-513W-1
		7/8	3/4	3-1/2	.045	447-514-1	447-514W-1
		7/8	3/4	3-1/2	.060	447-515-1	447-515W-1
		7/8	3/4	3-1/2	.090	447-516-1	447-516W-1
		1-1/2	3/4	4	.015	445-501-1	445-501W-1
		1-1/2	3/4	4	.020	445-502-1	445-502W-1
1-1/2	3/4	4	.030	445-503-1	445-503W-1		
1-1/2	3/4	4	.045	445-504-1	445-504W-1		
1-1/2	3/4	4	.060	445-505-1	445-505W-1		
1-1/2	3/4	4	.090	445-506-1	445-506W-1		
1-1/2	3/4	4	.125	445-507-1	445-507W-1		
1-5/8	3/4	4	.015	445-511-1	445-511W-1		
1-5/8	3/4	4	.020	445-512-1	445-512W-1		
1-5/8	3/4	4	.030	445-513-1	445-513W-1		
1-5/8	3/4	4	.045	445-514-1	445-514W-1		
1-5/8	3/4	4	.060	445-515-1	445-515W-1		
1-5/8	3/4	4	.090	445-516-1	445-516W-1		
2-1/4	3/4	5	.015	446-451-1	446-451W-1		
2-1/4	3/4	5	.020	446-452-1	446-452W-1		
2-1/4	3/4	5	.030	446-453-1	446-453W-1		
2-1/4	3/4	5	.060	446-455-1	446-455W-1		

High Performance



HY5 CORNER RADIUS ENDMILLS

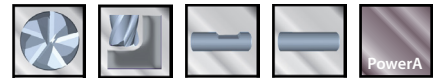

5 Flutes • Coated • With and without Flat

- High Performance A-Gr-SIV submicron grain carbide
- Unique 5 flute design for faster speeds and feeds
- MAP certified quality

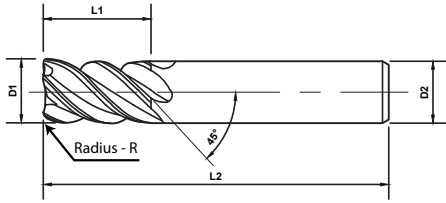

Length Key (K)

Standard Stub Long



K	OD	LOC	SHK	OAL	Radius	PowerA	
	D1	L1	D2	L2	R	No Flat	With Flat
3/4	3/4	2-1/4	3/4	5	.090	446-456-1	446-456W-1
		2-1/4	3/4	5	.125	446-457-1	446-457W-1
		3	3/4	6	.015	446-461-1	446-461W-1
		3	3/4	6	.020	446-462-1	446-462W-1
		3	3/4	6	.030	446-463-1	446-463W-1
		3	3/4	6	.045	446-464-1	446-464W-1
		3	3/4	6	.060	446-465-1	446-465W-1
		3	3/4	6	.090	446-466-1	446-466W-1
		4	3/4	6	.015	446-471-1	446-471W-1
		4	3/4	6	.020	446-472-1	446-472W-1
		4	3/4	6	.030	446-473-1	446-473W-1
		4	3/4	6	.045	446-474-1	446-474W-1
		4	3/4	6	.060	446-475-1	446-475W-1
		4	3/4	6	.090	446-476-1	446-476W-1
1	1	1-1/2	1	4	.020	445-522-1	445-522W-1
		1-1/2	1	4	.030	445-523-1	445-523W-1
		1-1/2	1	4	.045	445-524-1	445-524W-1
		1-1/2	1	4	.060	445-525-1	445-525W-1
		1-1/2	1	4	.090	445-526-1	445-526W-1
		2-1/4	1	5	.015	446-481-1	446-481W-1
		2-1/4	1	5	.020	446-482-1	446-482W-1
		2-1/4	1	5	.030	446-483-1	446-483W-1
		2-1/4	1	5	.045	446-484-1	446-484W-1
		2-1/4	1	5	.060	446-485-1	446-485W-1
		2-1/4	1	5	.090	446-486-1	446-486W-1
		3	1	6	.015	446-491-1	446-491W-1
		3	1	6	.020	446-492-1	446-492W-1
		3	1	6	.030	446-493-1	446-493W-1
		3	1	6	.045	446-494-1	446-494W-1
		3	1	6	.060	446-495-1	446-495W-1
		3	1	6	.090	446-496-1	446-496W-1
		4	1	7	.015	446-501-1	446-501W-1
		4	1	7	.020	446-502-1	446-502W-1
		4	1	7	.030	446-503-1	446-503W-1
4	1	7	.045	446-504-1	446-504W-1		
4	1	7	.060	446-505-1	446-505W-1		
4	1	7	.090	446-506-1	446-506W-1		

F45 6FL SQUARE ENDMILLS

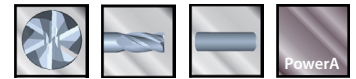

6 Flutes • Coated and Uncoated

- High Performance A-Gr-SiV submicron grain carbide
- 45° 6 flute design for superior finish
- MAP certified quality

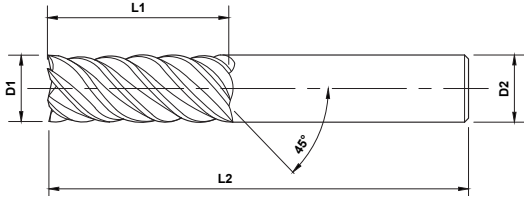

High Performance



Standard, Series 411



Standard, Series 411, PowerA

Length Key (K)

Standard Stub Long

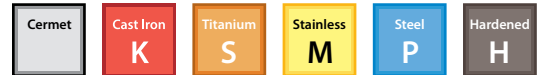

	OD	LOC	SHK	OAL	Uncoated	PowerA	
K	D1	L1	D2	L2			
Standard	3/16	5/8	3/16	2	411-002	411-002-1	
	1/4	3/4	1/4	2-1/2	411-004	411-004-1	
	5/16	7/8	5/16	2-1/2	411-006	411-006-1	
	3/8	1	3/8	2-1/2	411-008	411-008-1	
	7/16	1	7/16	2-1/2	411-010	411-010-1	
	1/2	1	1/2	3	411-012	411-012-1	
	9/16	1	9/16	3	411-014	411-014-1	
	5/8	1-1/4	5/8	3-1/2	411-016	411-016-1	
	3/4	1-1/2	3/4	4	411-018	411-018-1	
	7/8	1-1/2	7/8	4	411-020	411-020-1	
	Stub	1	1-1/2	1	4	411-022	411-022-1
			2-1/4	1	5	411-024	411-024-1

F45 6FL CORNER RADIUS ENDMILLS



6 Flutes • Coated and Uncoated

- High Performance A-Gr-SiV submicron grain carbide
- 45° 6 flute design for superior finish
- MAP certified quality

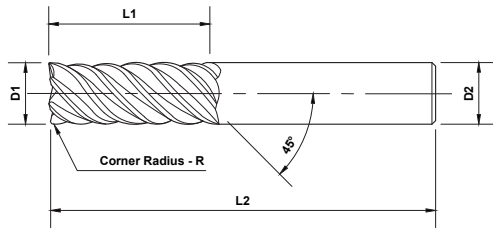

Standard, Series 411



Standard, Series 411, PowerA

Length Key (K)

Standard Stub Long



	OD	LOC	SHK	OAL	Radius	Uncoated	PowerA
K	D1	L1	D2	L2	R	6 Flute	6 Flute
	1/4	3/4	1/4	2-1/2	.010	411-200	411-200-1
	5/16	7/8	5/16	2-1/2	.012	411-210	411-210-1
	3/8	1	3/8	2-1/2	.012	411-220	411-220-1
	7/16	1	7/16	2-1/2	.015	411-231	411-231-1
	1/2	1	1/2	3	.015	411-241	411-241-1
	9/16	1	9/16	3	.020	411-252	411-252-1
	5/8	1-1/4	5/8	3-1/2	.020	411-262	411-262-1
	3/4	1-1/2	3/4	4	.030	411-273	411-273-1
	7/8	1-1/2	7/8	4	.030	411-283	411-283-1
	1	1-1/2	1	4	.030	411-293	411-293-1

MOLD MILLS



CORNER RADIUS NECKED

4 and 6 Flutes • Coated and Uncoated

- High Performance A-Gr-SiV submicron grain carbide
- Superb quality for mold and die operation
- MAP certified quality

High Performance

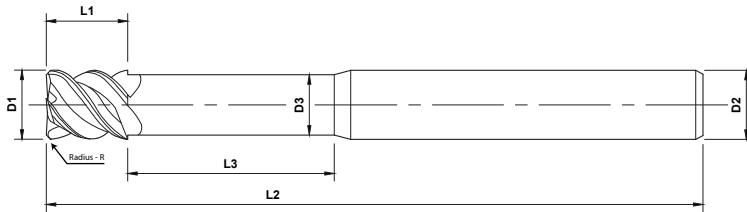

Long, Series 440

Length Key (K)

Standard Stub Long

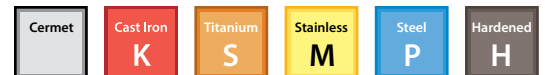

K	OD	LOC	SHK	OAL	Neck OD	Neck Length	Radius	Uncoated		PowerA		PowerN	
	D1	L1	D2	L2	D3	L3	R	4 Flute	6 Flute	4 Flute	6 Flute	4 Flute	6 Flute
1/8	1/8	1/8	1/8	2-1/4	.115	1/2	.010	440-002	-	440-002-1	-	440-002-5	-
	1/8	1/8	1/8	2-1/4	.115	1/2	.015	440-004	-	440-004-1	-	440-004-5	-
	1/8	1/8	1/8	2-1/4	.115	1/2	.020	440-006	-	440-006-1	-	440-006-5	-
3/16	3/16	3/16	3/16	2-1/2	.175	1/2	.010	440-008	-	440-008-1	-	440-008-5	-
	3/16	3/16	3/16	2-1/2	.175	1/2	.020	440-010	-	440-010-1	-	440-010-5	-
	3/16	3/16	3/16	2-1/2	.175	1/2	.030	440-012	-	440-012-1	-	440-012-5	-
1/4	1/4	1/4	1/4	2-1/2	.230	3/4	.010	-	440-014	-	440-014-1	-	440-014-5
	1/4	1/4	1/4	2-1/2	.230	3/4	.020	-	440-016	-	440-016-1	-	440-016-5
	1/4	1/4	1/4	2-1/2	.230	3/4	.030	-	440-018	-	440-018-1	-	440-018-5
	1/4	1/4	1/4	3	.230	3/4	.030	-	440-020	-	440-020-1	-	440-020-5
3/8	3/8	3/8	3/8	3	.345	1	.010	-	440-022	-	440-022-1	-	440-022-5
	3/8	3/8	3/8	3	.345	1	.020	-	440-024	-	440-024-1	-	440-024-5
	3/8	3/8	3/8	3	.345	1	.030	-	440-026	-	440-026-1	-	440-026-5
1/2	1/2	1/2	1/2	3-1/2	.460	1	.015	-	440-028	-	440-028-1	-	440-028-5
	1/2	1/2	1/2	3-1/2	.460	1	.030	-	440-030	-	440-030-1	-	440-030-5
	1/2	1/2	1/2	3-1/2	.460	1	.060	-	440-032	-	440-032-1	-	440-032-5
	1/2	1/2	1/2	4	.460	1	.060	-	440-034	-	440-034-1	-	440-034-5

MOLD MILLS



CORNER RADIUS NECKED LONG

4 and 6 Flutes • Coated and Uncoated

- High Performance A-Gr-SiV submicron grain carbide
- Superb quality for mold and die operation
- MAP certified quality

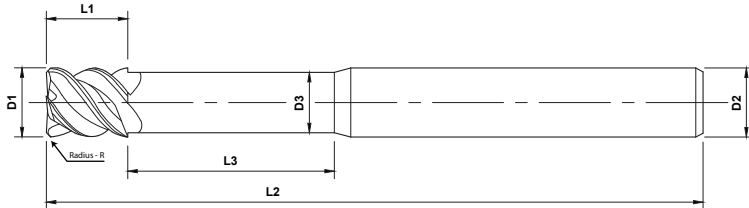

Long, Series 440

Length Key (K)

Standard Stub Long



K	OD	LOC	SHK	OAL	Neck OD	Neck Len.	Radius	Uncoated		PowerA		PowerN	
								4 Flute	6 Flute	4 Flute	6 Flute	4 Flute	6 Flute
1/8	1/8	1/8	1/8	4	0.115	1-1/4	.010	440-202	-	440-202-1	-	440-202-5	-
		1/8	1/8	4	0.115	1-1/4	.015	440-204	-	440-204-1	-	440-204-5	-
		1/8	1/8	4	0.115	1-1/4	.020	440-206	-	440-206-1	-	440-206-5	-
	3/16	3/16	3/16	4	0.175	1-1/2	.010	440-208	-	440-208-1	-	440-208-5	-
		3/16	3/16	4	0.175	1-1/2	.020	440-210	-	440-210-1	-	440-210-5	-
		3/16	3/16	4	0.175	1-1/2	.030	440-212	-	440-212-1	-	440-212-5	-
	1/4	1/4	1/4	6	0.230	2	.010	-	440-214	-	440-214-1	-	440-214-5
		1/4	1/4	6	0.230	2	.020	-	440-216	-	440-216-1	-	440-216-5
		1/4	1/4	6	0.230	2	.030	-	440-218	-	440-218-1	-	440-218-5
	3/8	3/8	3/8	6	0.345	2-1/4	.010	-	440-220	-	440-220-1	-	440-220-5
		3/8	3/8	6	0.345	2-1/4	.020	-	440-222	-	440-222-1	-	440-222-5
		3/8	3/8	6	0.345	2-1/4	.030	-	440-224	-	440-224-1	-	440-224-5
1/2	1/2	1/2	6	0.460	2-1/2	.015	-	440-226	-	440-226-1	-	440-226-5	
	1/2	1/2	6	0.460	2-1/2	.030	-	440-228	-	440-228-1	-	440-228-5	
	1/2	1/2	6	0.460	2-1/2	.060	-	440-230	-	440-230-1	-	440-230-5	

MOLD MILLS

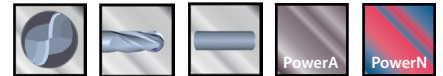

BALL NECKED

2 Flutes • Coated and Uncoated

- High Performance A-Gr-SiV submicron grain carbide
- Superb quality for mold and die operation
- MAP certified quality

High Performance

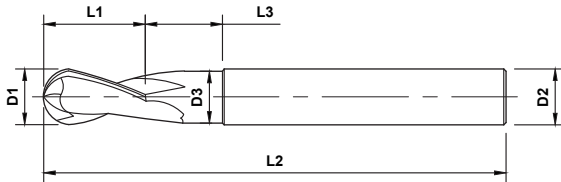

Standard, Series 440

Length Key (K)

Standard Stub Long

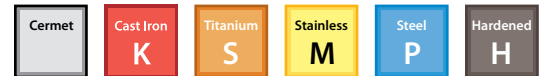

	OD	LOC	SHK	OAL	Neck OD	Neck Length	Uncoated	PowerA	PowerN
K	D1	L1	D2	L2	D3	L3			
	1/32	1/32	1/8	2-1/2	.027	3/32	440-402	440-402-1	440-402-5
		1/16	1/8	2-1/2	.053	3/16	440-404	440-404-1	440-404-5
	1/16	1/16	1/4	2	.053	3/16	440-406	440-406-1	440-406-5
		1/16	1/4	2-1/2	.053	3/16	440-408	440-408-1	440-408-5
	5/64	1/8	1/8	2	.067	3/16	440-410	440-410-1	440-410-5
		1/8	1/8	3	.115	3/8	440-412	440-412-1	440-412-5
	1/8	1/8	1/4	2-1/4	.115	3/8	440-414	440-414-1	440-414-5
		1/8	1/4	3	.115	3/8	440-416	440-416-1	440-416-5
	3/16	3/16	3/16	3	.175	9/16	440-418	440-418-1	440-418-5
		3/16	3/16	4	.175	9/16	440-420	440-420-1	440-420-5
		3/16	1/4	2-1/4	.175	9/16	440-422	440-422-1	440-422-5
		3/16	1/4	3	.175	9/16	440-424	440-424-1	440-424-5
	1/4	1/4	1/4	2-1/4	.230	3/4	440-426	440-426-1	440-426-5
		1/4	1/4	3	.230	1-1/2	440-428	440-428-1	440-428-5
	5/16	5/16	5/16	3	.285	1	440-430	440-430-1	440-430-5
		3/8	3/8	2-1/2	.345	5/8	440-432	440-432-1	440-432-5
	3/8	3/8	3/8	3-1/2	.345	1-1/8	440-434	440-434-1	440-434-5
		1/2	1/2	3	.460	3/4	440-436	440-436-1	440-436-5
	1/2	1/2	1/2	4	.460	1-1/8	440-438	440-438-1	440-438-5
		5/8	5/8	4-1/2	.575	2-1/4	440-440	440-440-1	440-440-5

MOLD MILLS

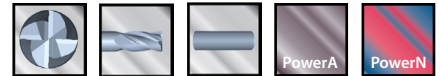

45° CORNER CHAMFER NECKED

4 Flutes • 55° Helix • Coated and Uncoated • .004" Corner Chamfer

- High Performance A-Gr-SiV submicron grain carbide
- Superb quality for mold and die operation
- MAP certified quality

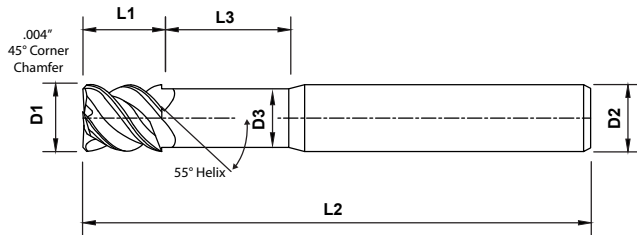

Standard, Series 441

Length Key (K)

Standard Stub Long



	OD	LOC	SHK	OAL	Neck OD	Neck Length	Uncoated	PowerA	PowerN
K	D1	L1	D2	L2	D3	L3			
	1/8	5/32	1/8	1-1/2	.115	3/8	441-202	441-202-1	441-202-5
	3/16	1/4	3/16	2	.175	1/2	441-204	441-204-1	441-204-5
	1/4	5/16	1/4	2-1/2	.230	1/2	441-206	441-206-1	441-206-5
	5/16	3/8	5/16	2-1/2	.288	1/2	441-208	441-208-1	441-208-5
	3/8	7/16	3/8	2-1/2	.345	1/2	441-210	441-210-1	441-210-5
	7/16	1/2	7/16	3	.403	9/16	441-212	441-212-1	441-212-5
	1/2	9/16	1/2	3	.460	5/8	441-214	441-214-1	441-214-5
	5/8	3/4	5/8	3-1/2	.575	3/4	441-216	441-216-1	441-216-5
	3/4	13/16	3/4	4	.710	7/8	441-218	441-218-1	441-218-5

3FL 60° HELIX TWISTERMILLS



3 Flutes • Coated and Uncoated

- High Performance A-Gr-SiV submicron grain carbide
- 60° Helix for stainless steels and hi-temp alloys
- MAP certified quality

High Performance

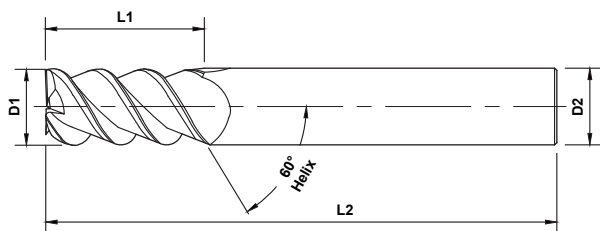

Standard, Series 432

Length Key (K)

Standard Stub Long

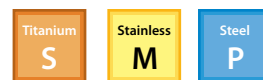

	OD	LOC	SHK	OAL	Uncoated	PowerA	PowerZ
K	D1	L1	D2	L2			
	1/8	5/8	1/8	1-1/2	432-002	432-002-1	432-002-4
	1/4	3/4	1/4	2-1/2	432-004	432-004-1	432-004-4
	7/16	1	7/16	3	432-006	432-006-1	432-006-4
	5/16	13/16	5/16	2-1/2	432-008	432-008-1	432-008-4
	3/8	1	3/8	2-1/2	432-010	432-010-1	432-010-4
	1/2	1	1/2	3	432-012	432-012-1	432-012-4
	5/8	1-1/4	5/8	3-1/2	432-014	432-014-1	432-014-4
	3/4	1-1/2	3/4	4	432-016	432-016-1	432-016-4
	1	1-1/2	1	4	432-018	432-018-1	432-018-4

ROUGHERS

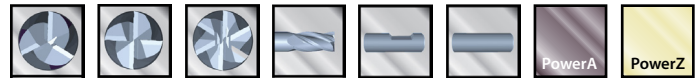

FINE PITCH

3, 4 and 6 Flutes • Coated and Uncoated • With and without flat

- High Performance A-Gr-SiV submicron grain carbide
- Rigid design for fast material removal
- MAP certified quality

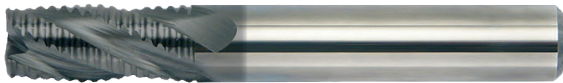
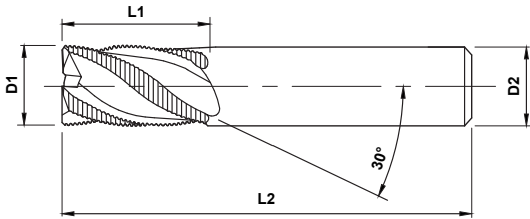

Standard, Series 433, PowerA



Standard, Series 433, PowerZ

Length Key (K)

Standard Stub Long



	OD	LOC	SHK	OAL	Flutes	Uncoated	PowerA	PowerZ
K	D1	L1	D2	L2				
	1/4	3/4	1/4	2-1/2	3	433-102	433-102-1	433-102-4
	5/16	3/4	5/16	2-1/2	3	433-104	433-104-1	433-104-4
	3/8	7/8	3/8	2-1/2	3	433-106	433-106-1	433-106-4
	1/2	1	1/2	3	4	433-108W	433-108W-1	433-108W-4
	5/8	1-1/4	5/8	3-1/2	4	433-110W	433-110W-1	433-110W-4
	3/4	1-1/2	3/4	4	4	433-112W	433-112W-1	433-112W-4
	1	1-1/2	1	4	6	433-114W	433-114W-1	433-114W-4

'W' appended to a part number indicates this tool is manufactured with a flat on the shank.

ROUGHERS

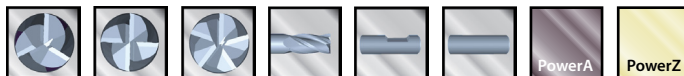

MEDIUM PITCH

3, 4 and 5 Flutes • Coated and Uncoated • With and without flat

- High Performance A-Gr-SiV submicron grain carbide
- Rigid design for fast material removal
- MAP certified quality

High Performance

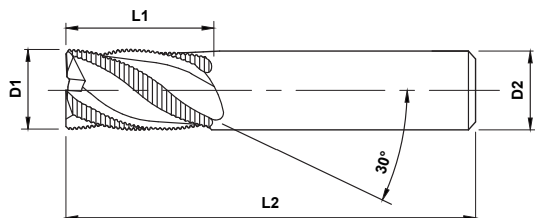

Standard, Series 433, PowerA



Standard, Series 433, PowerZ

Length Key (K)

Standard Stub Long

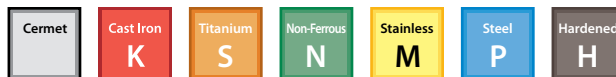

	OD	LOC	SHK	OAL	Flutes	Uncoated	PowerA	PowerZ
K	D1	L1	D2	L2				
	1/4	3/4	1/4	2-1/2	3	433-202	433-202-1	433-202-4
	5/16	3/4	5/16	2-1/2	3	433-204	433-204-1	433-204-4
	3/8	7/8	3/8	2-1/2	3	433-206	433-206-1	433-206-4
	1/2	1	1/2	3	4	433-208W	433-208W-1	433-208W-4
	5/8	1-1/4	5/8	3-1/2	4	433-210W	433-210W-1	433-210W-4
	3/4	1-1/2	3/4	4	4	433-212W	433-212W-1	433-212W-4
	1	1-1/2	1	4	5	433-214W	433-214W-1	433-214W-4

*'W' appended to a part number indicates this tool is manufactured with a flat on the shank.

ROUGHERS

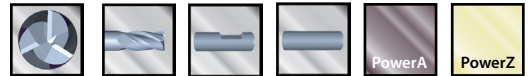

COARSE PITCH

3 Flutes • Coated and Uncoated • With and without flat

- High Performance A-Gr-SiV submicron grain carbide
- Rigid design for fast material removal
- MAP certified quality

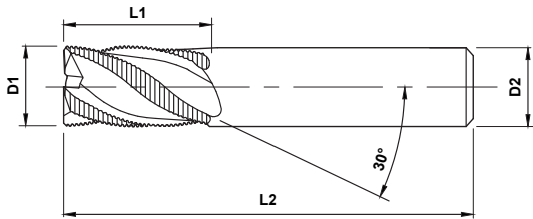

Standard, Series 433, PowerA



Standard, Series 433, PowerZ

Length Key (K)

Standard Stub Long

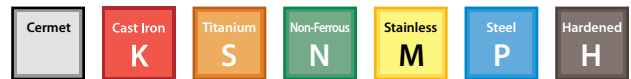

	OD	LOC	SHK	OAL	Flutes	Uncoated	PowerA	PowerZ
K	D1	L1	D2	L2				
	1/4	3/4	1/4	2-1/2	3	433-002	433-002-1	433-002-4
	5/16	3/4	5/16	2-1/2	3	433-004	433-004-1	433-004-4
	3/8	7/8	3/8	2-1/2	3	433-006	433-006-1	433-006-4
	1/2	1	1/2	3	3	433-008W	433-008W-1	433-008W-4
	5/8	1-1/4	5/8	3-1/2	3	433-010W	433-010W-1	433-010W-4
	3/4	1-1/2	3/4	4	3	433-012W	433-012W-1	433-012W-4
	1	1-1/2	1	4	3	433-014W	433-014W-1	433-014W-4

'W' appended to a part number indicates this tool is manufactured with a flat on the shank.

SQUARE END AXMILLS

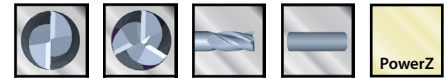

2 and 3 Flutes • Coated and Uncoated

- High Performance A-Gr-SiV submicron grain carbide
- Unique flute and relief angles for aluminum
- Faster speeds and feeds
- MAP certified quality

High Performance

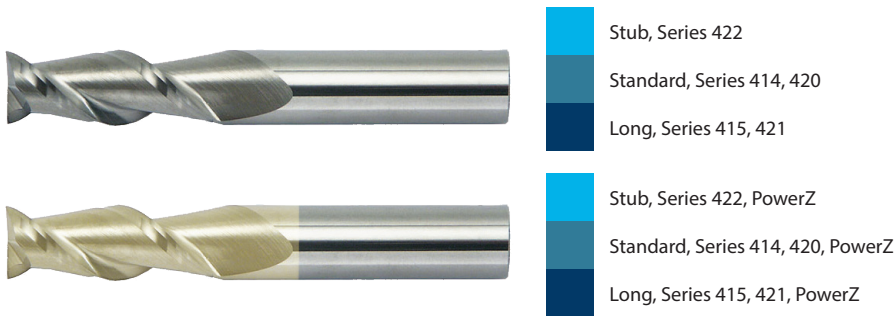
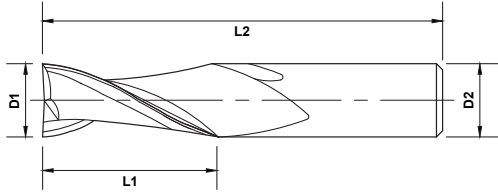

- Stub, Series 422
- Standard, Series 414, 420
- Long, Series 415, 421
- Stub, Series 422, PowerZ
- Standard, Series 414, 420, PowerZ
- Long, Series 415, 421, PowerZ

Length Key (K)

- Standard
- Stub
- Long



Quick Ship Items

K	OD	LOC	SHK	OAL	Uncoated		PowerZ	
					2 Flute	3 Flute	2 Flute	3 Flute
1/8	D1	1/4	1/8	1-1/2	-	422-002	-	422-002-4
		5/16	1/8	1-1/2	-	422-004	-	422-004-4
		3/8	1/8	1-1/2	-	422-006	-	422-006-4
		1/2	1/8	1-1/2	414-002	420-002	414-002-4	420-002-4
		1/2	1/8	2	-	421-070	-	421-070-4
		5/8	1/8	2	415-002	421-002	415-002-4	421-002-4
		3/4	1/8	2	415-004	421-004	415-004-4	421-004-4
		1	1/8	2-1/2	-	421-072	-	421-072-4
		1/4	1/8	3	-	421-074	-	421-074-4
		1	1/8	3	415-006	421-006	415-006-4	421-006-4
5/32	D1	9/16	5/32	2	414-004	420-004	414-004-4	420-004-4
		5/16	3/16	2	-	422-008	-	422-008-4
		9/16	3/16	2	-	420-038	-	420-038-4
3/16	D1	5/16	3/16	2	-	422-010	-	422-010-4
		3/8	3/16	2	-	422-012	-	422-012-4
		3/4	3/16	2	414-006	420-006	414-006-4	420-006-4
		5/8	3/16	2-1/2	-	421-076	-	421-076-4

SQUARE END AXMILLS

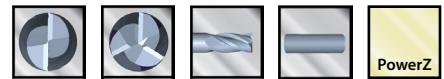

2 and 3 Flutes • Coated and Uncoated

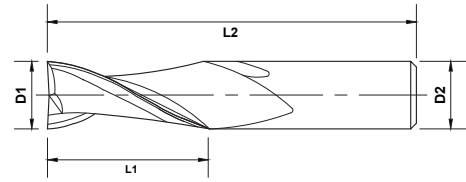

- High Performance A-Gr-SiV submicron grain carbide
- Unique flute and relief angles for aluminum
- Faster speeds and feeds
- MAP certified quality

Length Key (K)



Quick Ship Items

K	OD	LOC	SHK	OAL	Uncoated		PowerZ	
	D1	L1	D2	L2	2 Flute	3 Flute	2 Flute	3 Flute
3/16		3/4	3/16	2-1/2	415-008	421-008	415-008-4	421-008-4
		1	3/16	2-1/2	-	421-078	-	421-078-4
		5/16	3/16	3	-	421-080	-	421-080-4
		1-1/8	3/16	3	415-010	421-010	415-010-4	421-010-4
		1	3/16	4	415-012	421-012	415-012-4	421-012-4
7/32		3/8	1/4	2-1/2	-	422-014	-	422-014-4
		3/4	1/4	2-1/2	-	420-040	-	420-040-4
1/4		3/8	1/4	2-1/2	-	422-016	-	422-016-4
		1/2	1/4	2-1/2	-	422-018	-	422-018-4
		5/8	1/4	2-1/2	-	420-042	-	420-042-4
		3/4	1/4	2-1/2	414-008	420-008	414-008-4	420-008-4
		1	1/4	2-1/2	414-010	420-010	414-010-4	420-010-4
		1-1/8	1/4	2-1/2	-	421-082	-	421-082-4
		1-1/8	1/4	3	415-014	421-014	415-014-4	421-014-4
		1-1/4	1/4	3	-	421-084	-	421-084-4
		1-1/2	1/4	3	-	421-086	-	421-086-4
		3/8	1/4	4	-	421-088	-	421-088-4
		3/4	1/4	4	-	421-090	-	421-090-4
		1	1/4	4	415-016	421-016	415-016-4	421-016-4
		1-1/2	1/4	4	415-018	421-018	415-018-4	421-018-4
		2	1/4	4	-	421-092	-	421-092-4
1-1/2	1/4	6	415-020	421-020	415-020-4	421-020-4		
9/32		7/16	5/16	2-1/2	-	422-020	-	422-020-4
		13/16	5/16	2-1/2	-	420-044	-	420-044-4
5/16		7/16	5/16	2-1/2	-	422-022	-	422-022-4
		1/2	5/16	2-1/2	-	422-024	-	422-024-4
		3/4	5/16	2-1/2	414-012	420-012	414-012-4	420-012-4
		13/16	5/16	2-1/2	-	420-046	-	420-046-4
		1-1/8	5/16	2-1/2	-	421-094	-	421-094-4
		1	5/16	3	414-014	420-014	414-014-4	420-014-4
		1-1/8	5/16	3	415-022	421-022	415-022-4	421-022-4
		1-1/4	5/16	3-1/2	-	421-096	-	421-096-4
		1-1/2	5/16	3-1/2	-	421-098	-	421-098-4
7/16	5/16	4	-	421-100	-	421-100-4		

SQUARE END AXMILLS

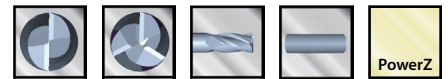

2 and 3 Flutes • Coated and Uncoated

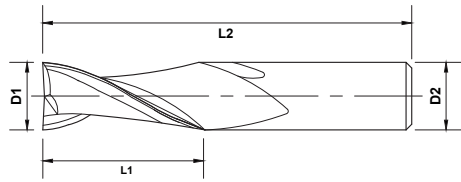

- High Performance A-Gr-SiV submicron grain carbide
- Unique flute and relief angles for aluminum
- Faster speeds and feeds
- MAP certified quality

Length Key (K)



High Performance

Quick Ship Items

K	OD	LOC	SHK	OAL	Uncoated		PowerZ	
	D1	L1	D2	L2	2 Flute	3 Flute	2 Flute	3 Flute
Standard	5/16	13/16	5/16	4	-	421-102	-	421-102-4
		1	5/16	4	415-024	421-024	415-024-4	421-024-4
		1-5/8	5/16	4	415-026	421-026	415-026-4	421-026-4
		2-1/8	5/16	4	-	421-104	-	421-104-4
		1-1/2	5/16	6	415-028	421-028	415-028-4	421-028-4
Stub	11/32	1/2	3/8	2-1/2	-	422-026	-	422-026-4
		1	3/8	2-1/2	-	420-048	-	420-048-4
Long	3/8	1/2	3/8	2-1/2	-	422-028	-	422-028-4
		5/8	3/8	2-1/2	-	422-030	-	422-030-4
		3/4	3/8	2-1/2	-	420-050	-	420-050-4
		7/8	3/8	2-1/2	414-016	420-016	414-016-4	420-016-4
		1	3/8	2-1/2	414-018	420-018	414-018-4	420-018-4
		1-1/8	3/8	3	415-030	421-030	415-030-4	421-030-4
		1-1/4	3/8	3	-	421-106	-	421-106-4
		1/2	3/8	4	-	421-108	-	421-108-4
		1	3/8	4	-	421-110	-	421-110-4
		1-1/2	3/8	4	-	421-112	-	421-112-4
		1-3/4	3/8	4	415-032	421-032	415-032-4	421-032-4
		2	3/8	4	415-034	421-034	415-034-4	421-034-4
		1-1/2	3/8	6	415-036	421-036	415-036-4	421-036-4
		2-1/2	3/8	6	-	421-114	-	421-114-4
3	3/8	6	415-038	421-038	415-038-4	421-038-4		
Stub	13/32	9/16	7/16	2-3/4	-	422-032	-	422-032-4
		1	7/16	2-3/4	-	420-052	-	420-052-4
Long	7/16	1	7/16	2-1/2	414-020	420-020	414-020-4	420-020-4
		9/16	7/16	2-3/4	-	422-034	-	422-034-4
		1	7/16	2-3/4	-	420-054	-	420-054-4
		1	7/16	4	415-040	421-040	415-040-4	421-040-4
		2	7/16	4	415-042	421-042	415-042-4	421-042-4
		1-1/2	7/16	6	415-044	421-044	415-044-4	421-044-4
		3	7/16	6	415-046	421-046	415-046-4	421-046-4

SQUARE END AXMILLS

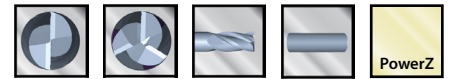

2 and 3 Flutes • Coated and Uncoated

- High Performance A-Gr-SiV submicron grain carbide
- Unique flute and relief angles for aluminum
- Faster speeds and feeds
- MAP certified quality

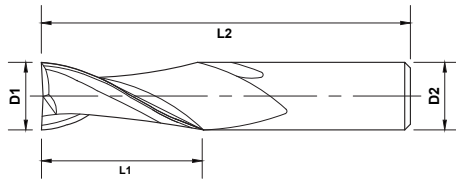

Length Key (K)



Quick Ship Items



K	OD	LOC	SHK	OAL	Uncoated		PowerZ	
	D1	L1	D2	L2	2 Flute	3 Flute	2 Flute	3 Flute
15/32		5/8	1/2	3	-	422-036	-	422-036-4
		1-1/4	1/2	3	-	420-056	-	420-056-4
1/2		5/8	1/2	3	-	422-038	-	422-038-4
		3/4	1/2	3	-	420-058	-	420-058-4
		1	1/2	3	414-022	420-022	414-022-4	420-022-4
		1-1/4	1/2	3	414-024	420-024	414-024-4	420-024-4
		5/8	1/2	4	-	421-116	-	421-116-4
		1-1/2	1/2	4	-	421-118	-	421-118-4
		2	1/2	4	415-052	421-052	415-052-4	421-052-4
		1	1/2	4	415-048	421-048	415-048-4	421-048-4
		5/8	1/2	6	-	421-120	-	421-120-4
		1-1/4	1/2	6	-	421-122	-	421-122-4
		1-1/2	1/2	6	415-050	421-050	415-050-4	421-050-4
		2-1/4	1/2	6	-	421-124	-	421-124-4
		2-1/2	1/2	6	-	421-126	-	421-126-4
		3	1/2	6	415-054	421-054	415-054-4	421-054-4
		3-1/4	1/2	6	-	421-128	-	421-128-4
		4	1/2	8	-	421-130	-	421-130-4
9/16		1-1/4	9/16	3	414-026	420-026	414-026-4	420-026-4
5/8		3/4	5/8	3-1/2	-	422-040	-	422-040-4
		1-1/4	5/8	3-1/2	414-028	420-028	414-028-4	420-028-4
		1-5/8	5/8	3-1/2	414-030	420-030	414-030-4	420-030-4
		3/4	5/8	5	-	422-042	-	422-042-4
		2	5/8	5	-	421-132	-	421-132-4
		2-1/4	5/8	5	415-056	421-056	415-056-4	421-056-4
		2-1/2	5/8	5	-	421-134	-	421-134-4
		2-3/4	5/8	5	-	421-136	-	421-136-4
		3/4	5/8	6	-	421-138	-	421-138-4
		1-5/8	5/8	6	-	421-140	-	421-140-4
		3	5/8	6	415-058	421-058	415-058-4	421-058-4
		3-1/4	5/8	6	-	421-142	-	421-142-4
		4	5/8	8	-	421-144	-	421-144-4

SQUARE END AXMILLS

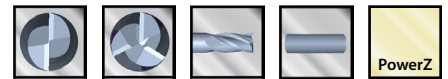

2 and 3 Flutes • Coated and Uncoated

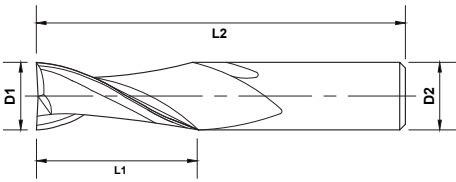

- High Performance A-Gr-SiV submicron grain carbide
- Unique flute and relief angles for aluminum
- Faster speeds and feeds
- MAP certified quality

High Performance

Length Key (K)

Standard
 Stub
 Long



Quick Ship Items

K	OD	LOC	SHK	OAL	Uncoated		PowerZ	
	D1	L1	D2	L2	2 Flute	3 Flute	2 Flute	3 Flute
3/4	3/4	1	3/4	4	-	420-060	-	420-060-4
		1-1/2	3/4	4	414-032	420-032	414-032-4	420-032-4
		1-5/8	3/4	4	-	420-062	-	420-062-4
		1-3/4	3/4	4	414-034	420-034	414-034-4	420-034-4
		1	3/4	5	-	421-146	-	421-146-4
		2	3/4	5	-	421-148	-	421-148-4
		2-1/4	3/4	5	415-060	421-060	415-060-4	421-060-4
		2-1/2	3/4	5	-	421-150	-	421-150-4
		1	3/4	6	-	421-152	-	421-152-4
		1-5/8	3/4	6	-	421-154	-	421-154-4
		3	3/4	6	415-062	421-062	415-062-4	421-062-4
		3-1/4	3/4	6	-	421-156	-	421-156-4
		3-1/2	3/4	6	-	421-158	-	421-158-4
		4	3/4	7	-	421-160	-	421-160-4
		5	3/4	8	-	421-162	-	421-162-4
1	1	1-1/2	1	4	414-036	420-036	414-036-4	420-036-4
		1-1/4	1	5	-	421-164	-	421-164-4
		1-1/2	1	5	-	421-166	-	421-166-4
		2	1	5	-	421-168	-	421-168-4
		2-1/2	1	5	-	421-170	-	421-170-4
		1-1/4	1	6	-	421-172	-	421-172-4
		2	1	6	415-064	421-064	415-064-4	421-064-4
		3	1	6	415-068	421-068	415-068-4	421-068-4
		3-1/2	1	6	-	421-174	-	421-174-4
		4	1	6	415-066	421-066	415-066-4	421-066-4
		1-1/4	1	7	-	421-176	-	421-176-4
		2	1	7	-	421-178	-	421-178-4
4-1/8	1	7	-	421-180	-	421-180-4		
5-1/2	1	8	-	421-182	-	421-182-4		
1-1/4	1-1/4	1-1/4	1-1/4	4-1/2	-	420-064	-	420-064-4
		2	1-1/4	4-1/2	-	421-184	-	421-184-4
		3-1/4	1-1/4	6	-	421-186	-	421-186-4
		5	1-1/4	7-1/2	-	421-188	-	421-188-4

BALL END AXMILLS

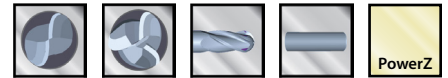

2 and 3 Flutes • Coated and Uncoated

- High Performance A-Gr-SiV submicron grain carbide
- Unique flute and relief angles for aluminum
- Faster speeds and feeds
- MAP certified quality

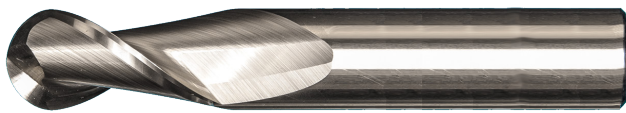
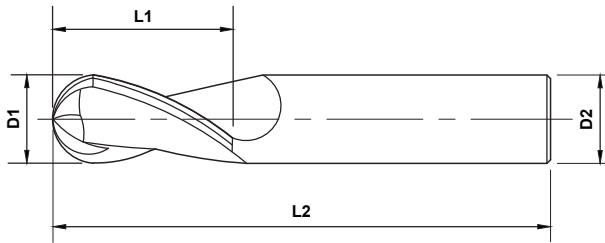

- Stub, Series 422
- Standard, Series 414, 420
- Long, Series 415, 421



- Stub, Series 422, PowerZ
- Standard, Series 414, 420, PowerZ
- Long, Series 415, 421, PowerZ

Length Key (K)

Standard Stub Long

Non-Ferrous
N

K	OD	LOC	SHK	OAL	Uncoated		PowerZ	
	D1	L1	D2	L2	2 Flute	3 Flute	2 Flute	3 Flute
1/8	1/8	1/2	1/8	1-1/2	414-202	420-202	414-202-4	420-202-4
		5/8	1/8	2	415-202	421-202	415-202-4	421-202-4
		3/4	1/8	2	415-204	421-204	415-204-4	421-204-4
		1	1/8	3	415-206	421-206	415-206-4	421-206-4
5/32	5/32	9/16	5/32	2	414-204	420-204	414-204-4	420-204-4
		3/4	3/16	2	414-206	420-206	414-206-4	420-206-4
3/16	3/16	3/4	3/16	2-1/2	415-208	421-208	415-208-4	421-208-4
		1-1/8	3/16	3	415-210	421-210	415-210-4	421-210-4
		1	3/16	4	415-212	421-212	415-212-4	421-212-4
		3/8	1/4	2-1/2	-	422-216	-	422-216-4
1/4	1/4	3/4	1/4	2-1/2	414-208	420-208	414-208-4	420-208-4
		1	1/4	2-1/2	414-210	420-210	414-210-4	420-210-4
		1-1/8	1/4	3	415-214	421-214	415-214-4	421-214-4
		1-1/4	1/4	3	-	421-284	-	421-284-4
		3/8	1/4	4	-	421-288	-	421-288-4
		1	1/4	4	415-216	421-216	415-216-4	421-216-4
		1-1/2	1/4	4	415-218	421-218	415-218-4	421-218-4
		1-1/2	1/4	6	415-220	421-220	415-220-4	421-220-4

BALL END AXMILLS

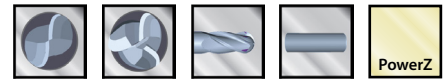

PowerZ

2 and 3 Flutes • Coated and Uncoated

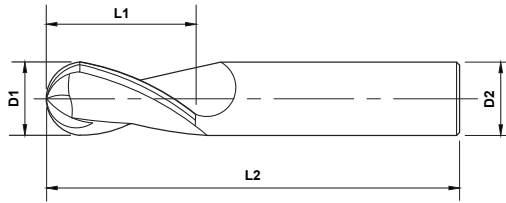

- High Performance A-Gr-SiV submicron grain carbide
- Unique flute and relief angles for aluminum
- Faster speeds and feeds
- MAP certified quality

High Performance

Length Key (K)

Standard Stub Long

Non-Ferrous
N

K	OD	LOC	SHK	OAL	Uncoated		PowerZ	
	D1	L1	D2	L2	2 Flute	3 Flute	2 Flute	3 Flute
5/16	5/16	7/16	5/16	2-1/2		422-222		422-222-4
		3/4	5/16	2-1/2	414-212	420-212	414-212-4	420-212-4
		13/16	5/16	2-1/2		420-246		420-246-4
		1	5/16	3	414-214	420-214	414-214-4	420-214-4
		1-1/8	5/16	3	415-222	421-222	415-222-4	421-222-4
		1-1/4	5/16	3-1/2		421-296		421-296-4
		7/16	5/16	4		421-300		421-300-4
		1	5/16	4	415-224	421-224	415-224-4	421-224-4
		1-5/8	5/16	4	415-226	421-226	415-226-4	421-226-4
3/8	3/8	1-1/2	5/16	6	415-228	421-228	415-228-4	421-228-4
		1/2	3/8	2-1/2		422-228		422-228-4
		7/8	3/8	2-1/2	414-216	420-216	414-216-4	420-216-4
		1	3/8	2-1/2	414-218	420-218	414-218-4	420-218-4
		1-1/8	3/8	3	415-230	421-230	415-230-4	421-230-4
		1/2	3/8	4		421-308		421-308-4
		1-1/2	3/8	4		421-312		421-312-4
		1-3/4	3/8	4	415-232	421-232	415-232-4	421-232-4
		2	3/8	4	415-234	421-234	415-234-4	421-234-4
7/16	7/16	1-1/2	3/8	6	415-236	421-236	415-236-4	421-236-4
		3	3/8	6	415-238	421-238	415-238-4	421-238-4
		1	7/16	2-1/2	414-220	420-220	414-220-4	420-220-4
		9/16	7/16	2-3/4		422-234		422-234-4
		1	7/16	2-3/4		420-254		420-254-4
		1	7/16	4	415-240	421-240	415-240-4	421-240-4
		2	7/16	4	415-242	421-242	415-242-4	421-242-4
1-1/2	7/16	6	415-244	421-244	415-244-4	421-244-4		
3	7/16	6	415-246	421-246	415-246-4	421-246-4		

BALL END AXMILLS

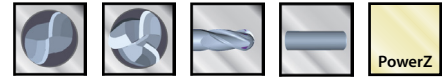

2 and 3 Flutes • Coated and Uncoated

- High Performance A-Gr-SiV submicron grain carbide
- Unique flute and relief angles for aluminum
- Faster speeds and feeds
- MAP certified quality

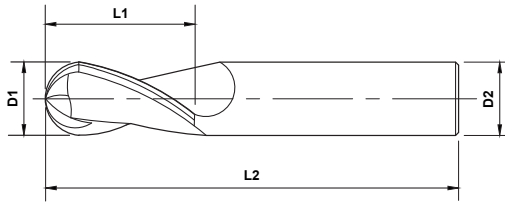

Length Key (K)

Standard Stub Long

Non-Ferrous
N

K	OD	LOC	SHK	OAL	Uncoated		PowerZ				
					2 Flute	3 Flute	2 Flute	3 Flute			
1/2	1/2	5/8	1/2	3		422-238		422-238-4			
		1	1/2	3	414-222	420-222	414-222-4	420-222-4			
		1-1/4	1/2	3	414-224	420-224	414-224-4	420-224-4			
		5/8	1/2	4		421-316		421-316-4			
		1	1/2	4	415-248	421-248	415-248-4	421-248-4			
		2	1/2	4	415-252	421-252	415-252-4	421-252-4			
		5/8	1/2	6		421-320		421-320-4			
		1-1/2	1/2	6	415-250	421-250	415-250-4	421-250-4			
	9/16	9/16	3	1/2	6	415-254	421-254	415-254-4	421-254-4		
			1-1/4	9/16	3	414-226	420-226	414-226-4	420-226-4		
			5/8	5/8	3/4	5/8	3-1/2		422-240		422-240-4
					1-1/4	5/8	3-1/2	414-228	420-228	414-228-4	420-228-4
					1-5/8	5/8	3-1/2	414-230	420-230	414-230-4	420-230-4
					3/4	5/8	5		422-242		422-242-4
					2-1/4	5/8	5	415-256	421-256	415-256-4	421-256-4
					2-1/2	5/8	5		421-334		421-334-4
3/4	5/8	6				421-338		421-338-4			
3	5/8	6			415-258	421-258	415-258-4	421-258-4			
3/4	3/4	1	3/4	4		420-260		420-260-4			
		1-1/2	3/4	4	414-232	420-232	414-232-4	420-232-4			
		1-5/8	3/4	4		420-262		420-262-4			
		1-3/4	3/4	4	414-234	420-234	414-234-4	420-234-4			
		1	3/4	5		421-346		421-346-4			
		2-1/4	3/4	5	415-260	421-260	415-260-4	421-260-4			
		1	3/4	6		421-352		421-352-4			
		3	3/4	6	415-262	421-262	415-262-4	421-262-4			
1	1	3-1/4	3/4	6		421-356		421-356-4			
		1-1/2	1	4	414-236	420-236	414-236-4	420-236-4			
		1-1/4	1	5		421-364		421-364-4			
		2	1	5		421-368		421-368-4			
		1-1/4	1	6		421-372		421-372-4			
		2	1	6	415-264	421-264	415-264-4	421-264-4			
		3	1	6	415-268	421-268	415-268-4	421-268-4			
		3-1/2	1	6		421-374		421-374-4			
1	1	4	1	6	415-266	421-266	415-266-4	421-266-4			
		1-1/4	1	7		421-376		421-376-4			

CORNER RADIUS AXMILLS

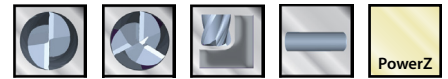

2 and 3 Flutes • Coated and Uncoated

- High Performance A-Gr-SiV submicron grain carbide
- Unique flute and relief angles for aluminum
- Faster speeds and feeds
- MAP certified quality

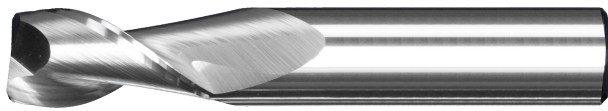
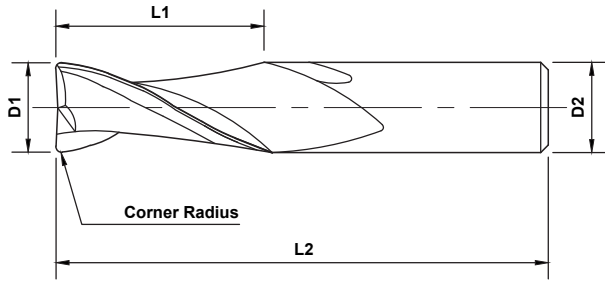

- Stub, Series 422
- Standard, Series 414, 420
- Long, Series 415, 415, 421



- Stub, Series 422, PowerZ
- Standard, Series 414, 420, PowerZ
- Long, Series 415, 421, PowerZ

Length Key (K)

Standard Stub Long

Non-Ferrous
N

K	OD	LOC	SHK	OAL	Radius	Uncoated		PowerZ	
						2 Flute	3 Flute	2 Flute	3 Flute
1/8	1/2	1/8	1/8	1-1/2	.015	414-401	420-401	414-401-4	420-401-4
						414-402	420-402	414-402-4	420-402-4
						414-403	420-403	414-403-4	420-403-4
						414-404	420-404	414-404-4	420-404-4
	5/8	1/8	1/8	2	.015	415-401	421-401	415-401-4	421-401-4
						415-402	421-402	415-402-4	421-402-4
						415-403	421-403	415-403-4	421-403-4
						415-404	421-404	415-404-4	421-404-4
		3/4	1/8	2	.015	415-411	421-411	415-411-4	421-411-4
						415-412	421-412	415-412-4	421-412-4
						415-413	421-413	415-413-4	421-413-4
						415-414	421-414	415-414-4	421-414-4
	1	1/8	3	.015	415-421	421-421	415-421-4	421-421-4	
					415-422	421-422	415-422-4	421-422-4	
					415-423	421-423	415-423-4	421-423-4	
					415-424	421-424	415-424-4	421-424-4	
5/32	9/16	5/32	2	.015	414-411	420-411	414-411-4	420-411-4	
					414-412	420-412	414-412-4	420-412-4	
					414-413	420-413	414-413-4	420-413-4	
					414-414	420-414	414-414-4	420-414-4	
3/16	3/4	3/16	2-1/2	.015	415-431	421-431	415-431-4	421-431-4	
					415-432	421-432	415-432-4	421-432-4	

CORNER RADIUS AXMILLS

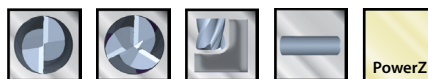

2 and 3 Flutes • Coated and Uncoated

- High Performance A-Gr-SiV submicron grain carbide
- Unique flute and relief angles for aluminum
- Faster speeds and feeds
- MAP certified quality

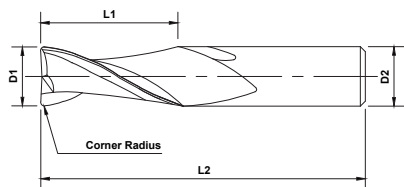

Length Key (K)

Standard Stub Long

Non-Ferrous
N

K	OD	LOC	SHK	OAL	Radius	Uncoated		PowerZ	
	D1	L1	D2	L2	R	2 Flute	3 Flute	2 Flute	3 Flute
3/16	3/16	3/4	3/16	2-1/2	.030	415-433	421-433	415-433-4	421-433-4
		3/4	3/16	2-1/2	.040	415-434	421-434	415-434-4	421-434-4
		3/4	3/16	2	.015	414-421	420-421	414-421-4	420-421-4
		3/4	3/16	2	.020	414-422	420-422	414-422-4	420-422-4
		3/4	3/16	2	.030	414-423	420-423	414-423-4	420-423-4
		3/4	3/16	2	.040	414-424	420-424	414-424-4	420-424-4
		1-1/8	3/16	3	.015	415-441	421-441	415-441-4	421-441-4
		1-1/8	3/16	3	.020	415-442	421-442	415-442-4	421-442-4
		1-1/8	3/16	3	.030	415-443	421-443	415-443-4	421-443-4
		1-1/8	3/16	3	.040	415-444	421-444	415-444-4	421-444-4
		1	3/16	4	.015	415-451	421-451	415-451-4	421-451-4
		1	3/16	4	.020	415-452	421-452	415-452-4	421-452-4
		1	3/16	4	.030	415-453	421-453	415-453-4	421-453-4
1/4	1/4	3/8	1/4	2-1/2	.015	-	422-401	-	422-401-4
		3/8	1/4	2-1/2	.020	-	422-402	-	422-402-4
		3/8	1/4	2-1/2	.030	-	422-403	-	422-403-4
		3/4	1/4	2-1/2	.015	414-431	420-431	414-431-4	420-431-4
		3/4	1/4	2-1/2	.020	414-432	420-432	414-432-4	420-432-4
		3/4	1/4	2-1/2	.030	414-433	420-433	414-433-4	420-433-4
		3/4	1/4	2-1/2	.040	414-434	420-434	414-434-4	420-434-4
		3/4	1/4	2-1/2	.060	414-425	420-425	414-425-4	420-425-4
		1	1/4	2-1/2	.015	414-441	420-441	414-441-4	420-441-4
		1	1/4	2-1/2	.020	414-442	420-442	414-442-4	420-442-4
		1	1/4	2-1/2	.030	414-443	420-443	414-443-4	420-443-4
		1	1/4	2-1/2	.040	414-444	420-444	414-444-4	420-444-4
		1	1/4	2-1/2	.060	414-445	420-445	414-445-4	420-445-4
		1-1/8	1/4	3	.015	415-461	421-461	415-461-4	421-461-4
		1-1/8	1/4	3	.020	415-462	421-462	415-462-4	421-462-4
		1-1/8	1/4	3	.030	415-463	421-463	415-463-4	421-463-4
		1-1/8	1/4	3	.040	415-464	421-464	415-464-4	421-464-4
		1-1/8	1/4	3	.060	415-465	421-465	415-465-4	421-465-4
		1-1/2	1/4	4	.015	415-481	421-481	415-481-4	421-481-4
		1-1/2	1/4	4	.020	415-482	421-482	415-482-4	421-482-4
		1-1/2	1/4	4	.030	415-483	421-483	415-483-4	421-483-4
		1-1/2	1/4	4	.040	415-484	421-484	415-484-4	421-484-4
		1-1/2	1/4	4	.060	415-485	421-485	415-485-4	421-485-4
		1	1/4	4	.015	415-471	421-471	415-471-4	421-471-4
		1	1/4	4	.020	415-472	421-472	415-472-4	421-472-4
		1	1/4	4	.030	415-473	421-473	415-473-4	421-473-4
		1	1/4	4	.040	415-474	421-474	415-474-4	421-474-4
1	1/4	4	.060	415-475	421-475	415-475-4	421-475-4		
1-1/2	1/4	6	.015	415-491	421-491	415-491-4	421-491-4		

CORNER RADIUS AXMILLS



2 and 3 Flutes • Coated and Uncoated



- High Performance A-Gr-SiV submicron grain carbide
- Unique flute and relief angles for aluminum
- Faster speeds and feeds
- MAP certified quality

High Performance

Length Key (K)

Standard Stub Long

Non-Ferrous
N

K	OD	LOC	SHK	OAL	Radius	Uncoated		PowerZ	
	D1	L1	D2	L2	R	2 Flute	3 Flute	2 Flute	3 Flute
1/4		1-1/2	1/4	6	.020	415-492	421-492	415-492-4	421-492-4
		1-1/2	1/4	6	.030	415-493	421-493	415-493-4	421-493-4
		1-1/2	1/4	6	.040	415-494	421-494	415-494-4	421-494-4
		1-1/2	1/4	6	.060	415-495	421-495	415-495-4	421-495-4
5/16		3/4	5/16	2-1/2	.015	414-451	420-451	414-451-4	420-451-4
		3/4	5/16	2-1/2	.020	414-452	420-452	414-452-4	420-452-4
		3/4	5/16	2-1/2	.030	414-453	420-453	414-453-4	420-453-4
		3/4	5/16	2-1/2	.040	414-454	420-454	414-454-4	420-454-4
		3/4	5/16	2-1/2	.060	414-455	420-455	414-455-4	420-455-4
		1-1/8	5/16	3	.015	415-501	421-501	415-501-4	421-501-4
		1-1/8	5/16	3	.020	415-502	421-502	415-502-4	421-502-4
		1-1/8	5/16	3	.030	415-503	421-503	415-503-4	421-503-4
		1-1/8	5/16	3	.040	415-504	421-504	415-504-4	421-504-4
		1-1/8	5/16	3	.060	415-505	421-505	415-505-4	421-505-4
		1	5/16	3	.015	414-461	420-461	414-461-4	420-461-4
		1	5/16	3	.020	414-462	420-462	414-462-4	420-462-4
		1	5/16	3	.030	414-463	420-463	414-463-4	420-463-4
		1	5/16	3	.040	414-464	420-464	414-464-4	420-464-4
		1	5/16	3	.060	414-465	420-465	414-465-4	420-465-4
		1-5/8	5/16	4	.015	415-521	421-521	415-521-4	421-521-4
		1-5/8	5/16	4	.020	415-522	421-522	415-522-4	421-522-4
		1-5/8	5/16	4	.030	415-523	421-523	415-523-4	421-523-4
		1-5/8	5/16	4	.040	415-524	421-524	415-524-4	421-524-4
		1-5/8	5/16	4	.060	415-525	421-525	415-525-4	421-525-4
		1	5/16	4	.015	415-511	421-511	415-511-4	421-511-4
		1	5/16	4	.020	415-512	421-512	415-512-4	421-512-4
		1	5/16	4	.030	415-513	421-513	415-513-4	421-513-4
		1	5/16	4	.040	415-514	421-514	415-514-4	421-514-4
		1	5/16	4	.060	415-515	421-515	415-515-4	421-515-4
		1-1/2	5/16	6	.015	415-531	421-531	415-531-4	421-531-4
		1-1/2	5/16	6	.020	415-532	421-532	415-532-4	421-532-4
		1-1/2	5/16	6	.030	415-533	421-533	415-533-4	421-533-4
	1-1/2	5/16	6	.040	415-534	421-534	415-534-4	421-534-4	
	1-1/2	5/16	6	.060	415-535	421-535	415-535-4	421-535-4	
3/8		1/2	3/8	2-1/2	.020	-	422-412	-	422-412-4
		1/2	3/8	2-1/2	.030	-	422-413	-	422-413-4
		1/2	3/8	2-1/2	.040	-	422-414	-	422-414-4
		7/8	3/8	2-1/2	.010	414-471	420-471	414-471-4	420-471-4
		7/8	3/8	2-1/2	.020	414-472	420-472	414-472-4	420-472-4
		7/8	3/8	2-1/2	.030	414-473	420-473	414-473-4	420-473-4
		7/8	3/8	2-1/2	.040	414-474	420-474	414-474-4	420-474-4
		7/8	3/8	2-1/2	.060	414-475	420-475	414-475-4	420-475-4
		1	3/8	2-1/2	.015	414-481	420-481	414-481-4	420-481-4
		1	3/8	2-1/2	.020	414-482	420-482	414-482-4	420-482-4

CORNER RADIUS AXMILLS



2 and 3 Flutes • Coated and Uncoated

- High Performance A-Gr-SiV submicron grain carbide
- Unique flute and relief angles for aluminum
- Faster speeds and feeds
- MAP certified quality

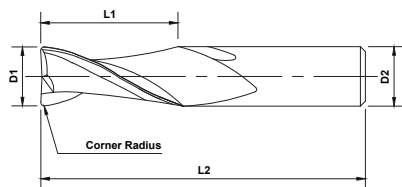

Length Key (K)

Standard Stub Long

Non-Ferrous
N

Quick Ship Items

K	OD	LOC	SHK	OAL	Radius	Uncoated		PowerZ	
	D1	L1	D2	L2	R	2 Flute	3 Flute	2 Flute	3 Flute
3/8	1	3/8	2-1/2	.030	414-483	420-483	414-483-4	420-483-4	
	1	3/8	2-1/2	.040	414-484	420-484	414-484-4	420-484-4	
	1	3/8	2-1/2	.060	414-485	420-485	414-485-4	420-485-4	
	1-1/8	3/8	3	.015	415-541	421-541	415-541-4	421-541-4	
	1-1/8	3/8	3	.020	415-542	421-542	415-542-4	421-542-4	
	1-1/8	3/8	3	.030	415-543	421-543	415-543-4	421-543-4	
	1-1/8	3/8	3	.040	415-544	421-544	415-544-4	421-544-4	
	1-1/8	3/8	3	.060	415-545	421-545	415-545-4	421-545-4	
	1-3/4	3/8	4	.015	415-551	421-551	415-551-4	421-551-4	
	1-3/4	3/8	4	.020	415-552	421-552	415-552-4	421-552-4	
	1-3/4	3/8	4	.030	415-553	421-553	415-553-4	421-553-4	
	1-3/4	3/8	4	.040	415-554	421-554	415-554-4	421-554-4	
	1-3/4	3/8	4	.060	415-555	421-555	415-555-4	421-555-4	
	2	3/8	4	.015	415-561	421-561	415-561-4	421-561-4	
	2	3/8	4	.020	415-562	421-562	415-562-4	421-562-4	
	2	3/8	4	.030	415-563	421-563	415-563-4	421-563-4	
	2	3/8	4	.040	415-564	421-564	415-564-4	421-564-4	
	2	3/8	4	.060	415-565	421-565	415-565-4	421-565-4	
	1-1/2	3/8	6	.015	415-571	421-571	415-571-4	421-571-4	
	1-1/2	3/8	6	.020	415-572	421-572	415-572-4	421-572-4	
1-1/2	3/8	6	.030	415-573	421-573	415-573-4	421-573-4		
1-1/2	3/8	6	.040	415-574	421-574	415-574-4	421-574-4		
1-1/2	3/8	6	.060	415-575	421-575	415-575-4	421-575-4		
3	3/8	6	.015	415-581	421-581	415-581-4	421-581-4		
3	3/8	6	.020	415-582	421-582	415-582-4	421-582-4		
3	3/8	6	.030	415-583	421-583	415-583-4	421-583-4		
3	3/8	6	.040	415-584	421-584	415-584-4	421-584-4		
3	3/8	6	.060	415-585	421-585	415-585-4	421-585-4		
7/16	1	7/16	2-1/2	.015	414-491	420-491	414-491-4	420-491-4	
	1	7/16	2-1/2	.020	414-492	420-492	414-492-4	420-492-4	
	1	7/16	2-1/2	.030	414-493	420-493	414-493-4	420-493-4	
	1	7/16	2-1/2	.040	414-494	420-494	414-494-4	420-494-4	
	1	7/16	2-1/2	.060	414-495	420-495	414-495-4	420-495-4	
	1	7/16	4	.015	415-591	421-591	415-591-4	421-591-4	
	1	7/16	4	.020	415-592	421-592	415-592-4	421-592-4	
	1	7/16	4	.030	415-593	421-593	415-593-4	421-593-4	
	1	7/16	4	.040	415-594	421-594	415-594-4	421-594-4	
	1	7/16	4	.060	415-595	421-595	415-595-4	421-595-4	
	2	7/16	4	.015	415-601	421-601	415-601-4	421-601-4	
	2	7/16	4	.020	415-602	421-602	415-602-4	421-602-4	
	2	7/16	4	.030	415-603	421-603	415-603-4	421-603-4	

CORNER RADIUS AXMILLS



High Performance

2 and 3 Flutes • Coated and Uncoated

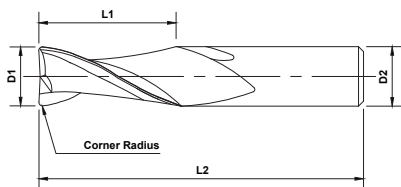

- High Performance A-Gr-SiV submicron grain carbide
- Unique flute and relief angles for aluminum
- Faster speeds and feeds
- MAP certified quality

Length Key (K)

Standard
 Stub
 Long

Quick Ship Items

Non-Ferrous
N

K	OD	LOC	SHK	OAL	Radius	Uncoated		PowerZ		
	D1	L1	D2	L2	R	2 Flute	3 Flute	2 Flute	3 Flute	
7/16		2	7/16	4	.040	415-604	421-604	415-604-4	421-604-4	
		2	7/16	4	.060	415-605	421-605	415-605-4	421-605-4	
		1-1/2	7/16	6	.015	415-611	421-611	415-611-4	421-611-4	
		1-1/2	7/16	6	.020	415-612	421-612	415-612-4	421-612-4	
		1-1/2	7/16	6	.030	415-613	421-613	415-613-4	421-613-4	
		1-1/2	7/16	6	.040	415-614	421-614	415-614-4	421-614-4	
		1-1/2	7/16	6	.060	415-615	421-615	415-615-4	421-615-4	
		3	7/16	6	.015	415-621	421-621	415-621-4	421-621-4	
		3	7/16	6	.020	415-622	421-622	415-622-4	421-622-4	
		3	7/16	6	.030	415-623	421-623	415-623-4	421-623-4	
		3	7/16	6	.040	415-624	421-624	415-624-4	421-624-4	
		3	7/16	6	.060	415-625	421-625	415-625-4	421-625-4	
	1/2		5/8	1/2	3	.020	-	422-422	-	422-422-4
			5/8	1/2	3	.030	-	422-423	-	422-423-4
			5/8	1/2	3	.060	-	422-425	-	422-425-4
			5/8	1/2	3	.090	-	422-426	-	422-426-4
		1-1/4	1/2	3	.015	414-511	420-511	414-511-4	420-511-4	
		1-1/4	1/2	3	.020	414-512	420-512	414-512-4	420-512-4	
		1-1/4	1/2	3	.030	414-513	420-513	414-513-4	420-513-4	
		1-1/4	1/2	3	.040	414-514	420-514	414-514-4	420-514-4	
		1-1/4	1/2	3	.060	414-515	420-515	414-515-4	420-515-4	
		1-1/4	1/2	3	.090	414-516	420-516	414-516-4	420-516-4	
		1-1/4	1/2	3	.120	414-517	420-517	414-517-4	420-517-4	
		1	1/2	3	.015	414-501	420-501	414-501-4	420-501-4	
		1	1/2	3	.020	414-502	420-502	414-502-4	420-502-4	
		1	1/2	3	.030	414-503	420-503	414-503-4	420-503-4	
		1	1/2	3	.040	414-504	420-504	414-504-4	420-504-4	
		1	1/2	3	.060	414-505	420-505	414-505-4	420-505-4	
		1	1/2	3	.090	414-506	420-506	414-506-4	420-506-4	
		1	1/2	3	.120	414-507	420-507	414-507-4	420-507-4	
		1	1/2	4	.015	415-631	421-631	415-631-4	421-631-4	
		1	1/2	4	.020	415-632	421-632	415-632-4	421-632-4	
		1	1/2	4	.030	415-633	421-633	415-633-4	421-633-4	
		1	1/2	4	.040	415-634	421-634	415-634-4	421-634-4	
		1	1/2	4	.060	415-635	421-635	415-635-4	421-635-4	
		1	1/2	4	.090	415-636	421-636	415-636-4	421-636-4	
	1	1/2	4	.120	415-637	421-637	415-637-4	421-637-4		
	2	1/2	4	.015	415-651	421-651	415-651-4	421-651-4		
	2	1/2	4	.020	415-652	421-652	415-652-4	421-652-4		
	2	1/2	4	.030	415-653	421-653	415-653-4	421-653-4		
	2	1/2	4	.040	415-654	421-654	415-654-4	421-654-4		

CORNER RADIUS AXMILLS



2 and 3 Flutes • Coated and Uncoated

- High Performance A-Gr-SiV submicron grain carbide
- Unique flute and relief angles for aluminum
- Faster speeds and feeds
- MAP certified quality

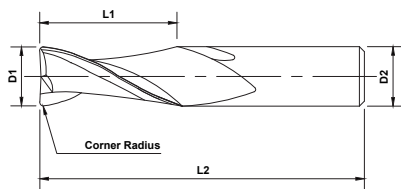

Length Key (K)

Standard Stub Long

Non-Ferrous
N

K	OD	LOC	SHK	OAL	Radius	Uncoated		PowerZ	
	D1	L1	D2	L2	R	2 Flute	3 Flute	2 Flute	3 Flute
1/2		2	1/2	4	.060	415-655	421-655	415-655-4	421-655-4
		2	1/2	4	.090	415-656	421-656	415-656-4	421-656-4
		2	1/2	4	.120	415-657	421-657	415-657-4	421-657-4
		1-1/2	1/2	6	.015	415-641	421-641	415-641-4	421-641-4
		1-1/2	1/2	6	.020	415-642	421-642	415-642-4	421-642-4
		1-1/2	1/2	6	.030	415-643	421-643	415-643-4	421-643-4
		1-1/2	1/2	6	.040	415-644	421-644	415-644-4	421-644-4
		1-1/2	1/2	6	.060	415-645	421-645	415-645-4	421-645-4
		1-1/2	1/2	6	.090	415-646	421-646	415-646-4	421-646-4
		1-1/2	1/2	6	.120	415-647	421-647	415-647-4	421-647-4
		3	1/2	6	.015	415-661	421-661	415-661-4	421-661-4
		3	1/2	6	.020	415-662	421-662	415-662-4	421-662-4
		3	1/2	6	.030	415-663	421-663	415-663-4	421-663-4
		3	1/2	6	.040	415-664	421-664	415-664-4	421-664-4
		3	1/2	6	.060	415-665	421-665	415-665-4	421-665-4
		3	1/2	6	.090	415-666	421-666	415-666-4	421-666-4
3	1/2	6	.120	415-667	421-667	415-667-4	421-667-4		
9/16		1-1/4	9/16	3	.015	414-521	420-521	414-521-4	420-521-4
		1-1/4	9/16	3	.020	414-522	420-522	414-522-4	420-522-4
		1-1/4	9/16	3	.030	414-523	420-523	414-523-4	420-523-4
		1-1/4	9/16	3	.040	414-524	420-524	414-524-4	420-524-4
		1-1/4	9/16	3	.060	414-525	420-525	414-525-4	420-525-4
		1-1/4	9/16	3	.090	414-526	420-526	414-526-4	420-526-4
1-1/4	9/16	3	.120	414-527	420-527	414-527-4	420-527-4		
5/8		1-1/4	5/8	3-1/2	.015	414-531	420-531	414-531-4	420-531-4
		1-1/4	5/8	3-1/2	.020	414-532	420-532	414-532-4	420-532-4
		1-1/4	5/8	3-1/2	.030	414-533	420-533	414-533-4	420-533-4
		1-1/4	5/8	3-1/2	.040	414-534	420-534	414-534-4	420-534-4
		1-1/4	5/8	3-1/2	.060	414-535	420-535	414-535-4	420-535-4
		1-1/4	5/8	3-1/2	.090	414-536	420-536	414-536-4	420-536-4
		1-1/4	5/8	3-1/2	.120	414-537	420-537	414-537-4	420-537-4
		1-5/8	5/8	3-1/2	.015	414-541	420-541	414-541-4	420-541-4
		1-5/8	5/8	3-1/2	.020	414-542	420-542	414-542-4	420-542-4
		1-5/8	5/8	3-1/2	.030	414-543	420-543	414-543-4	420-543-4
		1-5/8	5/8	3-1/2	.040	414-544	420-544	414-544-4	420-544-4
		1-5/8	5/8	3-1/2	.060	414-545	420-545	414-545-4	420-545-4
		1-5/8	5/8	3-1/2	.090	414-546	420-546	414-546-4	420-546-4
		1-5/8	5/8	3-1/2	.120	414-547	420-547	414-547-4	420-547-4
2-1/4	5/8	5	.015	415-671	421-671	415-671-4	421-671-4		
2-1/4	5/8	5	.020	415-672	421-672	415-672-4	421-672-4		
2-1/4	5/8	5	.030	415-673	421-673	415-673-4	421-673-4		
2-1/4	5/8	5	.040	415-674	421-674	415-674-4	421-674-4		
2-1/4	5/8	5	.060	415-675	421-675	415-675-4	421-675-4		

CORNER RADIUS AXMILLS



2 and 3 Flutes • Coated and Uncoated

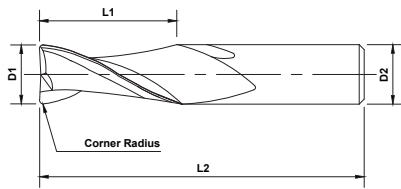

- High Performance A-Gr-SiV submicron grain carbide
- Unique flute and relief angles for aluminum
- Faster speeds and feeds
- MAP certified quality

Length Key (K)



Quick Ship Items



K	OD	LOC	SHK	OAL	Radius	Uncoated		PowerZ	
	D1	L1	D2	L2	R	2 Flute	3 Flute	2 Flute	3 Flute
5/8	2-1/4	5/8	5	.090	415-676	421-676	415-676-4	421-676-4	
	2-1/4	5/8	5	.120	415-677	421-677	415-677-4	421-677-4	
	3	5/8	6	.015	415-681	421-681	415-681-4	421-681-4	
	3	5/8	6	.020	415-682	421-682	415-682-4	421-682-4	
	3	5/8	6	.030	415-683	421-683	415-683-4	421-683-4	
	3	5/8	6	.040	415-684	421-684	415-684-4	421-684-4	
	3	5/8	6	.060	415-685	421-685	415-685-4	421-685-4	
	3	5/8	6	.090	415-686	421-686	415-686-4	421-686-4	
3/4	1-1/2	3/4	4	.015	414-561	420-561	414-561-4	420-561-4	
	1-1/2	3/4	4	.020	414-562	420-562	414-562-4	420-562-4	
	1-1/2	3/4	4	.030	414-563	420-563	414-563-4	420-563-4	
	1-1/2	3/4	4	.040	414-564	420-564	414-564-4	420-564-4	
	1-1/2	3/4	4	.060	414-565	420-565	414-565-4	420-565-4	
	1-1/2	3/4	4	.090	414-566	420-566	414-566-4	420-566-4	
	1-1/2	3/4	4	.120	414-567	420-567	414-567-4	420-567-4	
	1-5/8	3/4	4	.015	414-571	420-571	414-571-4	420-571-4	
	1-5/8	3/4	4	.020	414-572	420-572	414-572-4	420-572-4	
	1-5/8	3/4	4	.030	414-573	420-573	414-573-4	420-573-4	
	1-5/8	3/4	4	.040	414-574	420-574	414-574-4	420-574-4	
	1-5/8	3/4	4	.060	414-575	420-575	414-575-4	420-575-4	
	1-5/8	3/4	4	.090	414-576	420-576	414-576-4	420-576-4	
	1-5/8	3/4	4	.120	414-577	420-577	414-577-4	420-577-4	
	1-3/4	3/4	4	.015	414-581	420-581	414-581-4	420-581-4	
	1-3/4	3/4	4	.020	414-582	420-582	414-582-4	420-582-4	
	1-3/4	3/4	4	.030	414-583	420-583	414-583-4	420-583-4	
	1-3/4	3/4	4	.040	414-584	420-584	414-584-4	420-584-4	
	1-3/4	3/4	4	.060	414-585	420-585	414-585-4	420-585-4	
	1-3/4	3/4	4	.090	414-586	420-586	414-586-4	420-586-4	
	1-3/4	3/4	4	.120	414-587	420-587	414-587-4	420-587-4	
	1	3/4	4	.015	414-551	420-551	414-551-4	420-551-4	
	1	3/4	4	.020	414-552	420-552	414-552-4	420-552-4	
	1	3/4	4	.030	414-553	420-553	414-553-4	420-553-4	
	1	3/4	4	.040	414-554	420-554	414-554-4	420-554-4	
	1	3/4	4	.060	414-555	420-555	414-555-4	420-555-4	
	1	3/4	4	.090	414-556	420-556	414-556-4	420-556-4	
	1	3/4	4	.120	414-557	420-557	414-557-4	420-557-4	
2-1/4	3/4	5	.015	415-691	421-691	415-691-4	421-691-4		
2-1/4	3/4	5	.020	415-692	421-692	415-692-4	421-692-4		
2-1/4	3/4	5	.030	415-693	421-693	415-693-4	421-693-4		
2-1/4	3/4	5	.040	415-694	421-694	415-694-4	421-694-4		
2-1/4	3/4	5	.060	415-695	421-695	415-695-4	421-695-4		
2-1/4	3/4	5	.090	415-696	421-696	415-696-4	421-696-4		

High Performance



CORNER RADIUS AXMILLS



2 and 3 Flutes • Coated and Uncoated

- High Performance A-Gr-SiV submicron grain carbide
- Unique flute and relief angles for aluminum
- Faster speeds and feeds
- MAP certified quality

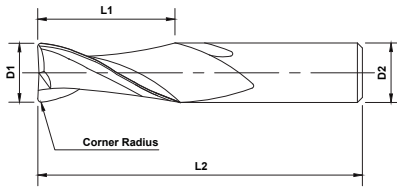

Length Key (K)

Standard Stub Long

Quick Ship Items

Non-Ferrous
N

K	OD	LOC	SHK	OAL	Radius	Uncoated		PowerZ	
	D1	L1	D2	L2	R	2 Flute	3 Flute	2 Flute	3 Flute
3/4	3/4	2-1/4	3/4	5	.120	415-697	421-697	415-697-4	421-697-4
		3	3/4	6	.010	415-702	421-702	415-702-4	421-702-4
		3	3/4	6	.015	415-701	421-701	415-701-4	421-701-4
		3	3/4	6	.030	415-703	421-703	415-703-4	421-703-4
		3	3/4	6	.040	415-704	421-704	415-704-4	421-704-4
		3	3/4	6	.060	415-705	421-705	415-705-4	421-705-4
		3	3/4	6	.090	415-706	421-706	415-706-4	421-706-4
		3	3/4	6	.120	415-707	421-707	415-707-4	421-707-4
1	1	1-1/2	1	4	.015	414-591	420-591	414-591-4	420-591-4
		1-1/2	1	4	.020	414-592	420-592	414-592-4	420-592-4
		1-1/2	1	4	.030	414-593	420-593	414-593-4	420-593-4
		1-1/2	1	4	.040	414-594	420-594	414-594-4	420-594-4
		1-1/2	1	4	.060	414-595	420-595	414-595-4	420-595-4
		1-1/2	1	4	.090	414-596	420-596	414-596-4	420-596-4
		1-1/2	1	4	.120	414-597	420-597	414-597-4	420-597-4
		2	1	6	.015	415-711	421-711	415-711-4	421-711-4
		2	1	6	.020	415-712	421-712	415-712-4	421-712-4
		2	1	6	.030	415-713	421-713	415-713-4	421-713-4
		2	1	6	.040	415-714	421-714	415-714-4	421-714-4
		2	1	6	.060	415-715	421-715	415-715-4	421-715-4
		2	1	6	.090	415-716	421-716	415-716-4	421-716-4
		2	1	6	.120	415-717	421-717	415-717-4	421-717-4
		3	1	6	.015	415-731	421-731	415-731-4	421-731-4
		3	1	6	.020	415-732	421-732	415-732-4	421-732-4
		3	1	6	.030	415-733	421-733	415-733-4	421-733-4
		3	1	6	.040	415-734	421-734	415-734-4	421-734-4
		3	1	6	.060	415-735	421-735	415-735-4	421-735-4
		3	1	6	.090	415-736	421-736	415-736-4	421-736-4
3	1	6	.120	415-737	421-737	415-737-4	421-737-4		
4	1	6	.015	415-721	421-721	415-721-4	421-721-4		
4	1	6	.020	415-722	421-722	415-722-4	421-722-4		
4	1	6	.030	415-723	421-723	415-723-4	421-723-4		
4	1	6	.040	415-724	421-724	415-724-4	421-724-4		
4	1	6	.060	415-725	421-725	415-725-4	421-725-4		
4	1	6	.090	415-726	421-726	415-726-4	421-726-4		
4	1	6	.120	415-727	421-727	415-727-4	421-727-4		

SQUARE END AXMILLS

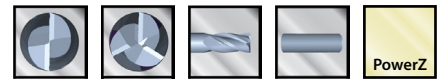

High Performance

CHIPBREAKER

2 and 3 Flutes • Coated and Uncoated

- High Performance A-Gr-SiV submicron grain carbide
- Unique flute and relief angles for aluminum
- Faster speeds and feeds
- MAP certified quality

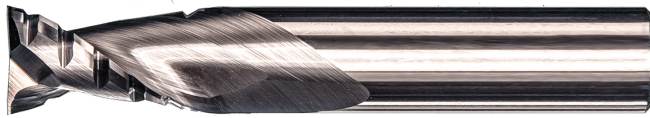
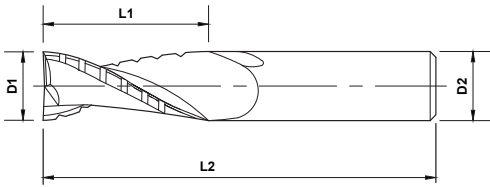

Standard, Series 417, 423



Standard, Series 417, 423, PowerZ

Length Key (K)

Standard Stub Long

Non-Ferrous
N

K	OD	LOC	SHK	OAL	Uncoated		PowerZ	
	D1	L1	D2	L2	2 Flute	3 Flute	2 Flute	3 Flute
1/8	1/2	1/8	1-1/2	417-002	423-002	417-002-4	423-002-4	
	9/16	5/32	2	417-004	423-004	417-004-4	423-004-4	
3/16	3/4	3/16	2	417-006	423-006	417-006-4	423-006-4	
	3/4	1/4	2-1/2	417-008	423-008	417-008-4	423-008-4	
1/4	1	1/4	2-1/2	417-010	423-010	417-010-4	423-010-4	
	3/4	5/16	2-1/2	417-012	423-012	417-012-4	423-012-4	
5/16	1	5/16	3	417-014	423-014	417-014-4	423-014-4	
	7/8	3/8	2-1/2	417-016	423-016	417-016-4	423-016-4	
3/8	1	3/8	2-1/2	417-018	423-018	417-018-4	423-018-4	
	1	7/16	2-1/2	417-020	423-020	417-020-4	423-020-4	
1/2	1	1/2	3	417-022	423-022	417-022-4	423-022-4	
	1-1/4	1/2	3	417-024	423-024	417-024-4	423-024-4	
9/16	1-1/4	9/16	3	417-026	423-026	417-026-4	423-026-4	
	1-1/4	5/8	3-1/2	417-028	423-028	417-028-4	423-028-4	
5/8	1-5/8	5/8	3-1/2	417-030	423-030	417-030-4	423-030-4	
	1-1/2	3/4	4	417-032	423-032	417-032-4	423-032-4	
3/4	1-3/4	3/4	4	417-034	423-034	417-034-4	423-034-4	
	1-1/2	1	4	417-036	423-036	417-036-4	423-036-4	

BALL END AXMILLS

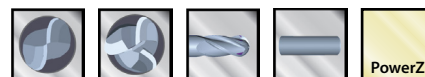

CHIPBREAKER

2 and 3 Flutes • Coated and Uncoated

- High Performance A-Gr-SiV submicron grain carbide
- Unique flute and relief angles for aluminum
- Faster speeds and feeds
- MAP certified quality

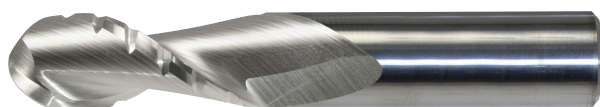
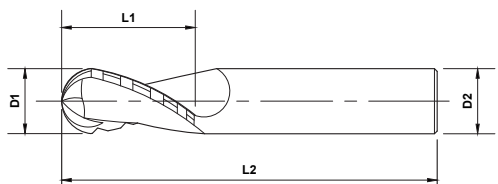

Standard, Series 417, 423

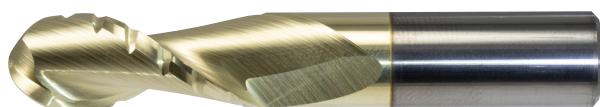

Standard, Series 417, 423, PowerZ

Length Key (K)

Standard Stub Long

Non-Ferrous
N

K	OD	LOC	SHK	OAL	Uncoated		PowerZ	
	D1	L1	D2	L2	2 Flute	3 Flute	2 Flute	3 Flute
K	1/8	1/2	1/8	1-1/2	417-202	423-202	417-202-4	423-202-4
	5/32	9/16	5/32	2	417-204	423-204	417-204-4	423-204-4
	3/16	3/4	3/16	2	417-206	423-206	417-206-4	423-206-4
	1/4	3/4	1/4	2-1/2	417-208	423-208	417-208-4	423-208-4
			1	2-1/2	417-210	423-210	417-210-4	423-210-4
	5/16	3/4	5/16	2-1/2	417-212	423-212	417-212-4	423-212-4
			1	3	417-214	423-214	417-214-4	423-214-4
	3/8	7/8	3/8	2-1/2	417-216	423-216	417-216-4	423-216-4
			1	2-1/2	417-218	423-218	417-218-4	423-218-4
	7/16	1	7/16	2-1/2	417-220	423-220	417-220-4	423-220-4
	1/2	1	1/2	3	417-222	423-222	417-222-4	423-222-4
			1-1/4	3	417-224	423-224	417-224-4	423-224-4
	9/16	1-1/4	9/16	3	417-226	423-226	417-226-4	423-226-4
	5/8	1-1/4	5/8	3-1/2	417-228	423-228	417-228-4	423-228-4
			1-5/8	3-1/2	417-230	423-230	417-230-4	423-230-4
	3/4	1-1/2	3/4	4	417-232	423-232	417-232-4	423-232-4
1-3/4			4	417-234	423-234	417-234-4	423-234-4	
1	1-1/2	1	4	417-236	423-236	417-236-4	423-236-4	

SQUARE END NECKED AXMILLS

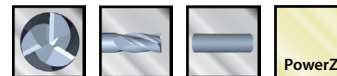

3 Flutes • Coated and Uncoated

- High Performance A-Gr-SiV submicron grain carbide
- Unique flute and relief angles for aluminum
- Faster speeds and feeds
- MAP certified quality

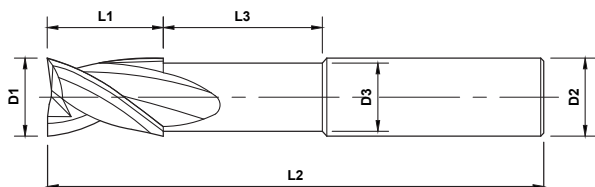

- Standard, Series, 426
- Long, Series 427

High Performance

Length Key (K)

- Standard
- Stub
- Long



	OD	LOC	SHK	OAL	Neck OD	Neck L	Uncoated	PowerZ
K	D1	L1	D2	L2	D3	L3	3 Flute	3 Flute
1/8	1/8	1/4	1/8	1-1/2	.115	1/4	426-002	426-002-4
		1/4	1/8	3	.115	1-1/8	427-002	427-002-4
3/16	3/16	5/16	3/16	2	.175	3/16	426-004	426-004-4
		5/16	3/16	3	.175	1-1/16	427-004	427-004-4
1/4	1/4	3/8	1/4	2-1/2	.235	3/4	426-006	426-006-4
		3/8	1/4	4	.235	1-3/4	427-006	427-006-4
		3/4	1/4	4	.235	1-3/8	427-008	427-008-4
5/16	5/16	7/16	5/16	2-1/2	.291	11/16	426-008	426-008-4
		7/16	5/16	4	.291	1-11/16	427-010	427-010-4
		13/16	5/16	4	.291	1-5/16	427-012	427-012-4
3/8	3/8	1/2	3/8	2-1/2	.355	5/8	426-010	426-010-4
		1/2	3/8	4	.355	1-5/8	427-014	427-014-4
		1	3/8	4	.355	1-1/8	427-016	427-016-4
1/2	1/2	5/8	1/2	3	.475	3/4	426-012	426-012-4
		5/8	1/2	4	.475	1-3/4	427-018	427-018-4
		5/8	1/2	6	.475	2-3/4	427-020	427-020-4
		1-1/4	1/2	6	.475	2-1/8	427-022	427-022-4
5/8	5/8	3/4	5/8	3-1/2	.519	7/8	426-014	426-014-4
		3/4	5/8	5	.519	1-5/8	427-024	427-024-4
		3/4	5/8	6	.519	2-5/8	427-026	427-026-4
		1-5/8	5/8	6	.519	1-3/4	427-028	427-028-4
3/4	3/4	1	3/4	4	.715	5/8	426-016	426-016-4
		1	3/4	5	.715	1-1/2	427-030	427-030-4
		1-5/8	3/4	6	.715	1-3/4	427-034	427-034-4
		1	3/4	6	.715	2-3/8	427-032	427-032-4
1	1	1-1/4	1	5	.960	7/8	426-018	426-018-4
		2	1	5	.960	1/8	427-040	427-040-4
		1-1/4	1	6	.960	2-1/8	427-036	427-036-4
		1-1/4	1	7	.960	3-1/8	427-038	427-038-4

BALL END NECKED AXMILLS

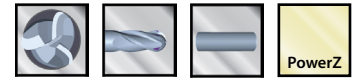

3 Flutes • Coated and Uncoated

- High Performance A-Gr-SiV submicron grain carbide
- Unique flute and relief angles for aluminum
- Faster speeds and feeds
- MAP certified quality

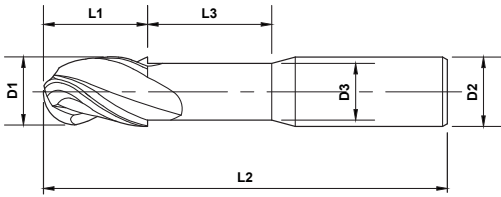

Length Key (K)

Standard Stub Long

Non-Ferrous
N

	OD	LOC	SHK	OAL	Neck OD	Neck L	Uncoated	PowerZ
K	D1	L1	D2	L2	D3	L3	3 Flute	3 Flute
Standard	1/8	1/4	1/8	1-1/2	.115	1/4	426-202	426-202-4
		1/4	1/8	3	.115	1-1/8	427-202	427-202-4
Standard	3/16	5/16	3/16	2	.175	3/16	426-204	426-204-4
		5/16	3/16	3	.175	1-1/16	427-204	427-204-4
Standard	1/4	3/8	1/4	2-1/2	.235	3/4	426-206	426-206-4
		3/8	1/4	4	.235	1-3/4	427-206	427-206-4
		3/4	1/4	4	.235	1-3/8	427-208	427-208-4
Standard	5/16	7/16	5/16	2-1/2	.291	11/16	426-208	426-208-4
		7/16	5/16	4	.291	1-11/16	427-210	427-210-4
Standard	3/8	1/2	3/8	2-1/2	.355	5/8	426-210	426-210-4
		1/2	3/8	4	.355	1-5/8	427-214	427-214-4
		1	3/8	4	.355	1-1/8	427-216	427-216-4
Standard	1/2	5/8	1/2	3	.475	1/2	426-212	426-212-4
		5/8	1/2	4	.475	1-3/4	427-218	427-218-4
		5/8	1/2	6	.475	2-3/4	427-220	427-220-4
		1-1/4	1/2	6	.475	2-1/8	427-222	427-222-4
Standard	5/8	3/4	5/8	3-1/2	.519	7/8	426-214	426-214-4
		3/4	5/8	5	.519	1-5/8	427-224	427-224-4
		3/4	5/8	6	.519	2-5/8	427-226	427-226-4
		1-5/8	5/8	6	.519	1-3/4	427-228	427-228-4
Standard	3/4	1	3/4	4	.715	5/8	426-216	426-216-4
		1	3/4	5	.715	1-1/2	427-230	427-230-4
		1-5/8	3/4	6	.715	1-3/4	427-234	427-234-4
		1	3/4	6	.715	2-3/8	427-232	427-232-4
Standard	1	1-1/4	1	5	.960	7/8	426-218	426-218-4
		2	1	5	.960	1/8	427-240	427-240-4
		1-1/4	1	6	.960	2-1/8	427-236	427-236-4
		1-1/4	1	7	.960	3-1/8	427-238	427-238-4

CORNER RADIUS NECKED AXMILLS



3 Flutes • Coated and Uncoated

- High Performance A-Gr-SiV submicron grain carbide
- Unique flute and relief angles for aluminum
- Faster speeds and feeds
- MAP certified quality

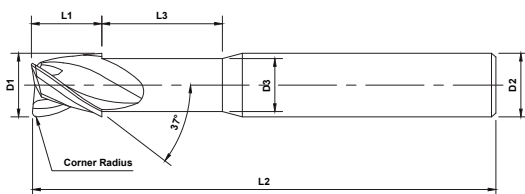

- Standard, Series 426
- Long, Series 427

Length Key (K)

Standard
 Stub
 Long



Quick Ship Items

	OD	LOC	SHK	OAL	Neck OD	Neck L	Radius	Uncoated	PowerZ
K	D1	L1	D2	L2	D3	L3	R	3 Flute	3 Flute
Standard	1/8	1/4	1/8	1-1/2	.115	1/4	.015	426-401	426-401-4
		1/4	1/8	3	.115	1-1/8	.015	427-401	427-401-4
Stub	3/16	5/16	3/16	2	.175	3/16	.020	426-412	426-412-4
		5/16	3/16	3	.175	1-1/16	.020	427-412	427-412-4
Standard	1/4	3/8	1/4	2-1/2	.235	3/4	.020	426-422	426-422-4
		3/8	1/4	4	.235	1-3/4	.020	427-422	427-422-4
		3/4	1/4	4	.235	1-3/8	.020	427-432	427-432-4
Stub	3/8	1/2	3/8	2-1/2	.355	11/16	.030	426-433	426-433-4
		1/2	3/8	4	.355	1-11/16	.030	427-443	427-443-4
Standard	1/2	5/8	1/2	3	.475	3/4	.030	426-443	426-443-4
		5/8	1/2	4	.475	1-3/4	.030	427-453	427-453-4
		5/8	1/2	6	.475	2-3/4	.030	427-463	427-463-4
		1-1/4	1/2	6	.475	2-1/8	.030	427-473	427-473-4
Stub	5/8	3/4	5/8	3-1/2	.519	3/4	.030	426-453	426-453-4
		3/4	5/8	5	.519	1-3/4	.030	427-483	427-483-4
		3/4	5/8	6	.519	2-3/4	.030	427-493	427-493-4
		1-5/8	5/8	6	.519	2-1/8	.030	427-503	427-503-4
Standard	3/4	1	3/4	4	.715	7/8	.030	426-463	426-463-4
		1	3/4	5	.715	1-5/8	.030	427-513	427-513-4
		1-5/8	3/4	6	.715	1-3/4	.030	427-533	427-533-4
		1	3/4	6	.715	2-5/8	.030	427-523	427-523-4
Long	1	1-1/4	1	5	.960	5/8	.030	426-473	426-473-4
		2	1	5	.960	1-3/4	.030	427-563	427-563-4
		1-1/4	1	6	.960	1-1/2	.030	427-543	427-543-4
		1-1/4	1	7	.960	2-3/8	.030	427-553	427-553-4

High Performance



45° 2 FLUTE HYPERMILLS



2 Flutes • Coated and Uncoated

- High Performance A-Gr-SiV submicron grain carbide
- Proven performer in aluminum



Standard, Series 428, PowerZ

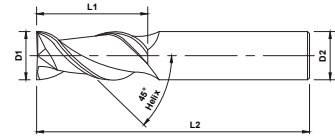

Length Key (K)

Standard Stub Long

Non-Ferrous
N

	OD	LOC	SHK	OAL	Uncoated	PowerA	PowerZ
K	D1	L1	D2	L2	2 Flute	2 Flute	2 Flute
	1/4	1	1/4	2-1/2	428-002	428-002-1	428-002-4
	5/16	1	5/16	3	428-004	428-004-1	428-004-4
	3/8	1	3/8	2-1/2	428-006	428-006-1	428-006-4
	1/2	1-1/4	1/2	3	428-008	428-008-1	428-008-4
	5/8	1-5/8	5/8	3-1/2	428-010	428-010-1	428-010-4
	3/4	1-3/4	3/4	4	428-012	428-012-1	428-012-4
	1	1-1/2	1	4	428-014	428-014-1	428-014-4

45° 3 FLUTE HYPERMILLS

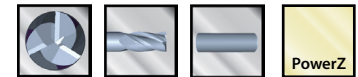

3 Flutes • With Wiper Flat • Coated and Uncoated

- High Performance A-Gr-SiV submicron grain carbide
- Proven performer in aluminum



Standard, Series 462, PowerZ

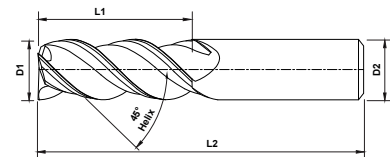

Length Key (K)

Standard Stub Long

Non-Ferrous
N

	OD	LOC	SHK	OAL	Uncoated	PowerZ
K	D1	L1	D2	L2	3 Flute	3 Flute
	1/8	1/2	1/8	1-1/2	462-002	462-002-4
	3/16	5/8	3/16	2	462-004	462-004-4
	1/4	3/4	1/4	2-1/2	462-006	462-006-4
	5/16	7/8	5/16	2-1/2	462-008	462-008-4
	3/8	7/8	3/8	2-1/2	462-010	462-010-4
	1/2	1	1/2	3	462-012	462-012-4
	1/2	1-1/2	1/2	3	462-014	462-014-4
	5/8	1-1/4	5/8	3-1/2	462-016	462-016-4
	3/4	1-1/2	3/4	4	462-018	462-018-4
	1	1-1/2	1	4	462-020	462-020-4

55° HELIX SQUARE ALUMAZIPS

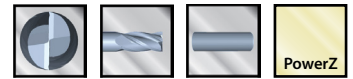

2 Flutes • Coated and Uncoated

- High Performance A-Gr-SiV submicron grain carbide
- Unique design for speed and finish in aluminum

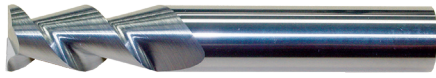

Standard, Series 428

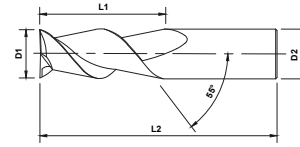

Non-Ferrous
N

High Performance

	OD	LOC	SHK	OAL	Uncoated	PowerZ
K	D1	L1	D2	L2	2 Flute	2 Flute
	1/8	1/2	1/8	1-1/2	428-202	428-202-4
	5/32	9/16	5/32	2	428-204	428-204-4
	3/16	3/4	3/16	2	428-206	428-206-4
	1/4	3/4	1/4	2-1/2	428-208	428-208-4
	5/16	3/4	5/16	2-1/2	428-210	428-210-4
	3/8	7/8	3/8	2-1/2	428-212	428-212-4
	1/2	1	1/2	3	428-214	428-214-4
	9/16	1-1/4	9/16	3	428-216	428-216-4
	5/8	1-1/4	5/8	3-1/2	428-218	428-218-4
	3/4	1-1/2	3/4	4	428-220	428-220-4
	1	1-1-2	1	4	428-222	428-222-4

PRO+ PERFORMANCE ENDMILLS

- **V4 Pro+**
- **V5 Pro+**
- **HY5 Pro+**
- **F45 Pro+**
- **V7 Pro+**











PRO+

Harness the power of our silicon based coatings; PowerN and PowerNR.









These coatings make our tools outstanding in high heat applications suited for hard material machining.

Our special honed flutes result in quieter running and an increase in overall tool precision.

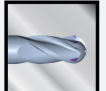
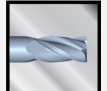

TABLE OF CONTENTS

	V4 Pro+ Square Endmills . . . V4%	102	Cermet	Hardened H	Cast Iron K	Titanium S	Stainless M	Steel P
	V4 Pro+ Ball Endmills. . . V4%	103	Cermet	Hardened H	Cast Iron K	Titanium S	Stainless M	Steel P
	V4 Pro+ Corner Radius Endmills. . . V4%	104	Cermet	Hardened H	Cast Iron K	Titanium S	Stainless M	Steel P
	V5 Pro+ Square Endmills . . . V5%	105	Cermet	Hardened H	Cast Iron K	Titanium S	Stainless M	Steel P
	V5 Pro+ Ball Endmills. . . V5%	106	Cermet	Hardened H	Cast Iron K	Titanium S	Stainless M	Steel P
	V5 Pro+ Corner Radius Endmills. . . V5%	107	Cermet	Hardened H	Cast Iron K	Titanium S	Stainless M	Steel P
	HY5 Pro+ Square Endmills . . . HY5	108	Cermet	Hardened H	Cast Iron K	Titanium S	Stainless M	Steel P
	HY5 Pro+ Corner Radius Endmills. . . HY5	109	Cermet	Hardened H	Cast Iron K	Titanium S	Stainless M	Steel P
	F45 Pro+ Square Endmills. . . F45	110	Cermet	Hardened H	Cast Iron K	Titanium S	Stainless M	Steel P
	F45 Pro+ Corner Radius Endmills . . . F45	110	Cermet	Hardened H	Cast Iron K	Titanium S	Stainless M	Steel P
	V7 Pro+ Endmills V7	111	Cermet	Hardened H	Cast Iron K	Titanium S	Stainless M	Steel P

Features Legend

	4 Flutes		Plain shank
	5 Flutes		Flat Shank
	6+ Flutes		Corner Radius
	Ball End		Square End
	4 Flutes Ball		5 Flutes Ball

Coatings Legend

	Power N Coating
	Power NR Coating

Mastercut's Superior Carbide Blend – A-Gr-SiV (Active Grain Sized Volume)

Our superior tungsten carbide gives you the ability to be *aggressive* when you need to be. Growth inhibitors in our submicron carbide blanks maintain the most consistent grain size available, giving you superior hardness AND toughness.

Please contact us for our full line of metric products.

V4 PRO+ SQUARE ENDMILLS

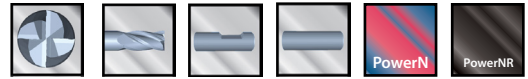

4 Flutes • Coated with and without Flat

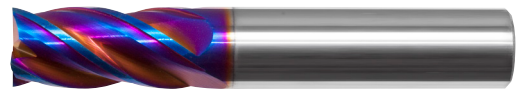
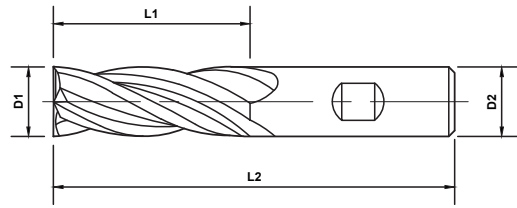

- Stub, Series 452, PowerN
- Standard, Series 450, PowerN
- Long, Series 451, PowerN

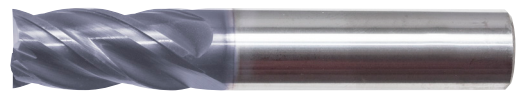

- Stub, Series 452, PowerNR
- Standard, Series 450, PowerNR
- Long, Series 451, PowerNR



Length Key (K)

■ Standard
 ■ Stub
 ■ Long

Cermat
 Cast Iron
K
 Titanium
S
 Stainless
M
 Steel
P
 Hardened
H

K	OD	LOC	SHK	OAL	PowerN		PowerNR	
					No Flat	With Flat	No Flat	With Flat
1/8	1/8	1/4	1/8	1-1/2	452-004-5	-	452-004-8	-
		3/8	1/8	1-1/2	450-002-5	-	450-002-8	-
3/16	3/16	3/8	3/16	2	452-006-5	-	452-006-8	-
		7/16	3/16	2	450-006-5	-	450-006-8	-
		3/4	3/16	2-1/2	450-042-5	-	450-042-8	-
1/4	1/4	1/2	1/4	2	452-010-5	452-010W-5	452-010-8	452-010W-8
		5/8	1/4	2-1/2	450-010-5	450-010W-5	450-010-8	450-010W-8
		3/4	1/4	2-1/2	450-040-5	450-040W-5	450-040-8	450-040W-8
		1-1/8	1/4	3	451-002-5	451-002W-5	451-002-8	451-002W-8
5/16	5/16	1/2	5/16	2	452-012-5	452-012W-5	452-012-8	452-012W-8
		13/16	5/16	2-1/2	450-012-5	450-012W-5	450-012-8	450-012W-8
		1-1/8	5/16	3	451-004-5	451-004W-5	451-004-8	451-004W-8
3/8	3/8	5/8	3/8	2	452-014-5	452-014W-5	452-014-8	452-014W-8
		7/8	3/8	2-1/2	450-016-5	450-016W-5	450-016-8	450-016W-8
1/2	1/2	5/8	1/2	2-1/2	452-018-5	452-018W-5	452-018-8	452-018W-8
		1	1/2	3	450-022-5	450-022W-5	450-022-8	450-022W-8
		1-1/4	1/2	3	450-024-5	450-024W-5	450-024-8	450-024W-8
		2	1/2	4	451-008-5	451-008W-5	451-008-8	451-008W-8
5/8	5/8	3/4	5/8	3	452-020-5	452-020W-5	452-020-8	452-020W-8
		1-1/4	5/8	3-1/2	450-028-5	450-028W-5	450-028-8	450-028W-8
		2-1/4	5/8	5	451-010-5	451-010W-5	451-010-8	451-010W-8
3/4	3/4	1	3/4	3	452-024-5	452-024W-5	452-024-8	452-024W-8
		1-1/2	3/4	4	450-030-5	450-030W-5	450-030-8	450-030W-8
		4	3/4	6	451-016-5	451-016W-5	451-016-8	451-016W-8
1	1	1-1/2	1	4	450-034-5	450-034W-5	450-034-8	450-034W-8
		3	1	6	451-020-5	451-020W-5	451-020-8	451-020W-8

We manufacture a full range of cutting diameters. Please call for availability.

V4 PRO+ BALL ENDMILLS

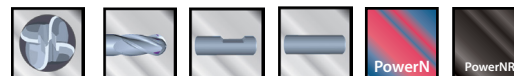

4 Flutes • Coated with and without Flat

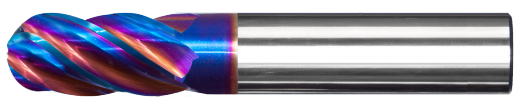
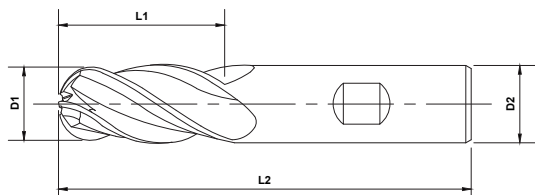

Stub, Series 452, PowerN
Standard, Series 450, PowerN
Long, Series 451, PowerN

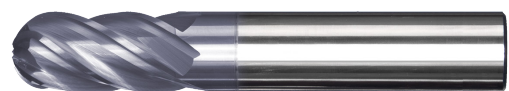

Stub, Series 452, PowerNR
Standard, Series 450, PowerNR
Long, Series 451, PowerNR



- Pro+ performance A-Gr-SiV submicron grain carbide
- Unique variable design, coating, and edge quality
- Best performance and finish on wide range of materials

Pro+ Performance Endmills

Length Key (K)

Standard Stub Long

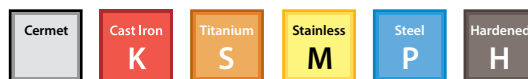

K	OD	LOC	SHK	OAL	PowerN		PowerNR	
					No Flat	With Flat	No Flat	With Flat
1/8	1/8	1/4	1/8	1-1/2	452-204-5	-	452-204-8	-
		3/8	1/8	1-1/2	450-202-5	-	450-202-8	-
3/16	3/16	3/8	3/16	2	452-206-5	-	452-206-8	-
		7/16	3/16	2	450-206-5	-	450-206-8	-
		3/4	3/16	2-1/2	450-242-5	-	450-242-8	-
1/4	1/4	1/2	1/4	2	452-210-5	452-210W-5	452-210-8	452-210W-8
		5/8	1/4	2-1/2	450-210-5	450-210W-5	450-210-8	450-210W-8
		3/4	1/4	2-1/2	450-240-5	450-240W-5	450-240-8	450-240W-8
		1-1/8	1/4	3	451-202-5	451-202W-5	451-202-8	451-202W-8
5/16	5/16	1/2	5/16	2	452-212-5	452-212W-5	452-212-8	452-212W-8
		13/16	5/16	2-1/2	450-212-5	450-212W-5	450-212-8	450-212W-8
		1-1/8	5/16	3	451-204-5	451-204W-5	451-204-8	451-204W-8
3/8	3/8	5/8	3/8	2	452-214-5	452-214W-5	452-214-8	452-214W-8
		7/8	3/8	2-1/2	450-216-5	450-216W-5	450-216-8	450-216W-8
1/2	1/2	5/8	1/2	2-1/2	452-218-5	452-218W-5	452-218-8	452-218W-8
		1	1/2	3	450-222-5	450-222W-5	450-222-8	450-222W-8
		1-1/4	1/2	3	450-224-5	450-224W-5	450-224-8	450-224W-8
		2	1/2	4	451-208-5	451-208W-5	451-208-8	451-208W-8
5/8	5/8	3/4	5/8	3	452-220-5	452-220W-5	452-220-8	452-220W-8
		1-1/4	5/8	3-1/2	450-228-5	450-228W-5	450-228-8	450-228W-8
		2-1/4	5/8	5	451-210-5	451-210W-5	451-210-8	451-210W-8
3/4	3/4	1	3/4	3	452-224-5	452-224W-5	452-224-8	452-224W-8
		1-1/2	3/4	4	450-230-5	450-230W-5	450-230-8	450-230W-8
		4	3/4	6	451-216-5	451-216W-5	451-216-8	451-216W-8
1	1	1-1/2	1	4	450-234-5	450-234W-5	450-234-8	450-234W-8
		3	1	6	451-220-5	451-220W-5	451-220-8	451-220W-8

We manufacture a full range of cutting diameters. Please call for availability.



V4 PRO+ CORNER RADIUS

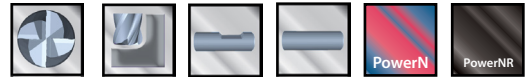

4 Flutes • Coated with and without Flat

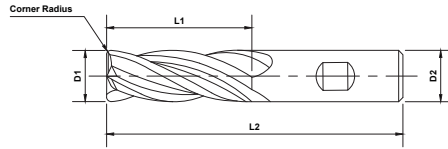

- Pro+ performance A-Gr-SiV submicron grain carbide
- Unique variable design, coating, and edge quality
- Best performance and finish on wide range of materials



- Stub, Series 452, PowerN
- Standard, Series 450, PowerN
- Long, Series 451, PowerN

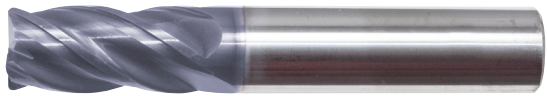

- Stub, Series 452, PowerNR
- Standard, Series 450, PowerNR
- Long, Series 451, PowerNR



Length Key (K)



K	OD	LOC	SHK	OAL	Radius	PowerN		PowerNR	
						No Flat	With Flat	No Flat	With Flat
1/8	1/8	1/4	1/8	1-1/2	.015	452-401-5	-	452-401-8	-
		1/4	1/8	1-1/2	.020	452-402-5	-	452-402-8	-
3/16	3/16	3/8	3/16	2	.020	452-422-5	-	452-422-8	-
		7/16	3/16	2	.020	450-412-5	-	450-412-8	-
1/4	1/4	3/4	3/16	2-1/2	.020	450-532-5	-	450-532-8	-
		1/2	1/4	2	.020	452-442-5	452-442W-5	452-442-8	452-442W-8
5/16	5/16	5/8	1/4	2-1/2	.020	450-422-5	450-422W-5	450-422-8	450-422W-8
		3/4	1/4	2-1/2	.020	450-542-5	450-542W-5	450-542-8	450-542W-8
3/8	3/8	1-1/8	1/4	3	.020	451-402-5	451-402W-5	451-402-8	451-402W-8
		1/2	5/16	2	.030	452-453-5	452-453W-5	452-453-8	452-453W-8
1/2	1/2	13/16	5/16	2-1/2	.030	450-433-5	450-433W-5	450-433-8	450-433W-8
		5/8	3/8	2	.030	452-463-5	452-463W-5	452-463-8	452-463W-8
5/8	5/8	7/8	3/8	2-1/2	.030	450-443-5	450-443W-5	450-443-8	450-443W-8
		1-1/8	3/8	3	.030	451-423-5	451-423W-5	451-423-8	451-423W-8
3/4	3/4	5/8	1/2	2-1/2	.030	452-483-5	452-483W-5	452-483-8	452-483W-8
		1	1/2	3	.030	450-463-5	450-463W-5	450-463-8	450-463W-8
1	1	1-1/4	1/2	3	.030	450-473-5	450-473W-5	450-473-8	450-473W-8
		2	1/2	4	.030	451-433-5	451-433W-5	451-433-8	451-433W-8
3/4	3/4	3/4	5/8	3	.030	452-493-5	452-493W-5	452-493-8	452-493W-8
		1-1/4	5/8	3-1/2	.030	450-493-5	450-493W-5	450-493-8	450-493W-8
1	1	2-1/4	5/8	5	.030	451-443-5	451-443W-5	451-443-8	451-443W-8
		1	3/4	3	.030	452-503-5	452-503W-5	452-503-8	452-503W-8
3/4	3/4	7/8	3/4	3-1/2	.030	452-513-5	452-513W-5	452-513-8	452-513W-8
		1-1/2	3/4	4	.030	450-503-5	450-503W-5	450-503-8	450-503W-8
1	1	1-5/8	3/4	4	.030	450-513-5	450-513W-5	450-513-8	450-513W-8
		3	3/4	6	.030	451-463-5	451-463W-5	451-463-8	451-463W-8
1	1	4	3/4	6	.030	451-473-5	451-473W-5	451-473-8	451-473W-8
		1-1/2	1	4	.045	450-524-5	450-524W-5	450-524-8	450-524W-8
1	1	2-1/4	1	5	.045	451-484-5	451-484W-5	451-484-8	451-484W-8
		3	1	6	.045	451-494-5	451-494W-5	451-494-8	451-494W-8

We manufacture a full range of cutting diameters and Endcut Radii. Please call for availability.

V5 PRO+ SQUARE ENDMILLS

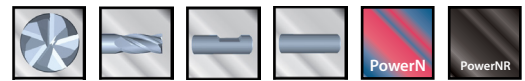

Pro+ Performance Endmills

5 Flutes • Coated with and without Flat

- Pro+ performance A-Gr-SiV submicron grain carbide
- Unique variable design, coating, and edge quality
- Best performance and finish on wide range of materials

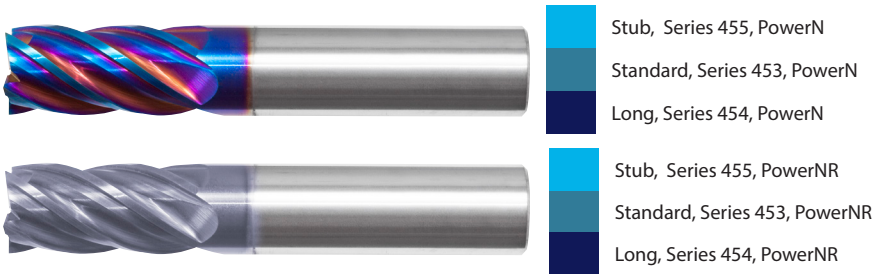
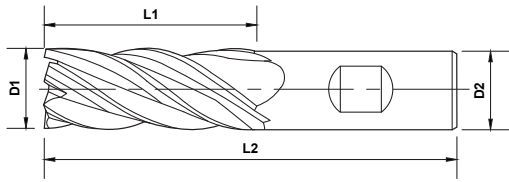

Length Key (K)



K	OD	LOC	SHK	OAL	PowerN		PowerNR	
					No Flat	With Flat	No Flat	With Flat
5/16	5/16	1/2	5/16	2	455-012-5	455-012W-5	455-012-8	455-012W-8
		13/16	5/16	2-1/2	453-008-5	453-008W-5	453-008-8	453-008W-8
3/8	3/8	5/8	3/8	2	455-014-5	455-014W-5	455-014-8	455-014W-8
		7/8	3/8	2-1/2	453-010-5	453-010W-5	453-010-8	453-010W-8
		1-1/8	3/8	3	454-004-5	454-004W-5	454-004-8	454-004W-8
1/2	1/2	5/8	1/2	2-1/2	455-018-5	455-018W-5	455-018-8	455-018W-8
		1	1/2	3	453-014-5	453-014W-5	453-014-8	453-014W-8
		1-1/4	1/2	3	453-016-5	453-016W-5	453-016-8	453-016W-8
		2	1/2	4	454-006-5	454-006W-5	454-006-8	454-006W-8
5/8	5/8	3/4	5/8	3	455-020-5	455-020W-5	455-020-8	455-020W-8
		1-1/4	5/8	3-1/2	453-020-5	453-020W-5	453-020-8	453-020W-8
		2-1/4	5/8	5	454-008-5	454-008W-5	454-008-8	454-008W-8
3/4	3/4	7/8	3/4	3-1/2	455-024-5	455-024W-5	455-024-8	455-024W-8
		1	3/4	3	455-022-5	455-022W-5	455-022-8	455-022W-8
		1-1/2	3/4	4	453-024-5	453-024W-5	453-024-8	453-024W-8
		1-5/8	3/4	4	453-022-5	453-022W-5	453-022-8	453-022W-8
		2-1/4	3/4	5	454-010-5	454-010W-5	454-010-8	454-010W-8
		3	3/4	6	454-012-5	454-012W-5	454-012-8	454-012W-8
1	1	1-1/2	1	4	453-026-5	453-026W-5	453-026-8	453-026W-8
		2-1/2	1	5	454-014-5	454-014W-5	454-014-8	454-014W-8
		3	1	6	454-016-5	454-016W-5	454-016-8	454-016W-8
		4	1	7	454-018-5	454-018W-5	454-018-8	454-018W-8

We manufacture a full range of cutting diameters. Please call for availability.

V5 PRO+ BALL ENDMILLS

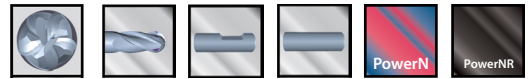

5 Flutes • Coated with and without Flat

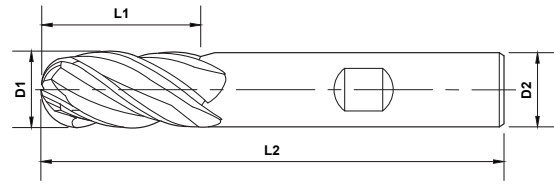

- Pro+ performance A-Gr-SiV submicron grain carbide
- Unique variable design, coating, and edge quality
- Best performance and finish on wide range of materials
- MAP certified quality

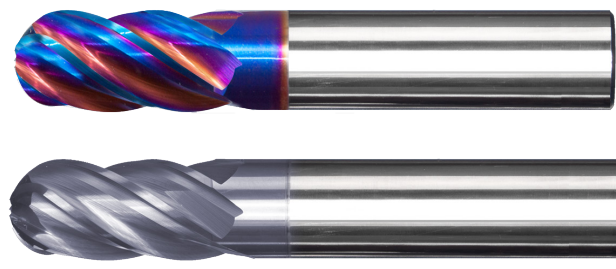

- Stub, Series 455, PowerN
- Standard, Series 453, PowerN
- Long, Series 454, PowerN
- Stub, Series 455, PowerNR
- Standard, Series 453, PowerNR
- Long, Series 454, PowerNR

Length Key (K)

Standard Stub Long



K	OD D1	LOC L1	SHK D2	OAL L2	PowerN		PowerNR	
					No Flat	With Flat	No Flat	With Flat
5/16	5/16	1/2	5/16	2	455-212-5	455-212W-5	455-212-8	455-212W-8
		13/16	5/16	2-1/2	453-208-5	453-208W-5	453-208-8	453-208W-8
3/8	3/8	5/8	3/8	2	455-214-5	455-214W-5	455-214-8	455-214W-8
		7/8	3/8	2-1/2	453-210-5	453-210W-5	453-210-8	453-210W-8
		1-1/8	3/8	3	454-204-5	454-204W-5	454-204-8	454-204W-8
		5/8	1/2	2-1/2	455-218-5	455-218W-5	455-218-8	455-218W-8
1/2	1/2	1	1/2	3	453-214-5	453-214W-5	453-214-8	453-214W-8
		1-1/4	1/2	3	453-216-5	453-216W-5	453-216-8	453-216W-8
		2	1/2	4	454-206-5	454-206W-5	454-206-8	454-206W-8
		3/4	5/8	3	455-220-5	455-220W-5	455-220-8	455-220W-8
5/8	5/8	1-1/4	5/8	3-1/2	453-220-5	453-220W-5	453-220-8	453-220W-8
		2-1/4	5/8	5	454-208-5	454-208W-5	454-208-8	454-208W-8
3/4	3/4	1	3/4	3	455-222-5	455-222W-5	455-222-8	455-222W-8
		1-1/2	3/4	4	453-222-5	453-222W-5	453-222-8	453-222W-8
		3	3/4	6	454-212-5	454-212W-5	454-212-8	454-212W-8
		1-1/2	1	4	453-226-5	453-226W-5	453-226-8	453-226W-8
1	1	3	1	6	454-216-5	454-216W-5	454-216-8	454-216W-8

We manufacture a full range of cutting diameters. Please call for availability.

V5 PRO+ CORNER RADIUS

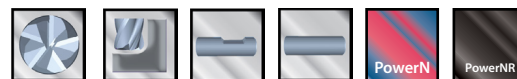

Pro+ Performance Endmills

5 Flutes • Coated with and without Flat

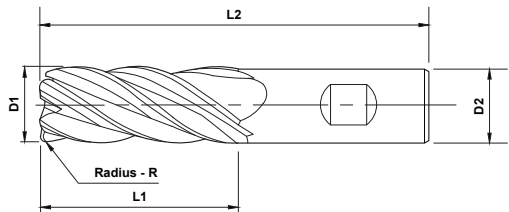

- Pro+ performance A-Gr-SiV submicron grain carbide
- Unique variable design, coating, and edge quality
- Best performance and finish on wide range of materials
- MAP certified quality

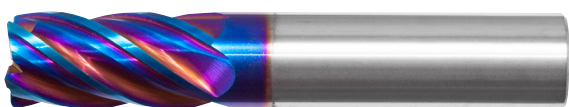

- Stub, Series 455, PowerN
- Standard, Series 453, 453, PowerN
- Long, Series 454, PowerN

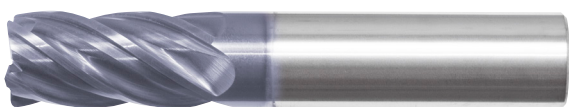

- Stub, Series 455, PowerNR
- Standard, Series 453, PowerNR
- Long, Series 454, PowerNR

Length Key (K)

Standard
 Stub
 Long



K	OD	LOC	SHK	OAL	Radius	PowerN		PowerNR	
	D1	L1	D2	L2	R	No Flat	With Flat	No Flat	With Flat
	5/16	1/2	5/16	2	.030	455-453-5	455-453W-5	455-453-8	455-453W-8
		13/16	5/16	2-1/2	.030	453-433-5	453-433W-5	453-433-8	453-433W-8
	3/8	7/8	3/8	2-1/2	.030	453-443-5	453-443W-5	453-443-8	453-443W-8
		1-1/8	3/8	3	.030	454-413-5	454-413W-5	454-413-8	454-413W-8
	1/2	5/8	1/2	2-1/2	.030	455-483-5	455-483W-5	455-483-8	455-483W-8
		1	1/2	3	.030	453-463-5	453-463W-5	453-463-8	453-463W-8
		2	1/2	4	.030	454-423-5	454-423W-5	454-423-8	454-423W-8
	5/8	3/4	5/8	3	.030	455-493-5	455-493W-5	455-493-8	455-493W-8
		1-1/4	5/8	3-1/2	.030	453-493-5	453-493W-5	453-493-8	453-493W-8
		2-1/4	5/8	5	.030	454-433-5	454-433W-5	454-433-8	454-433W-8
	3/4	1	3/4	3	.030	455-503-5	455-503W-5	455-503-8	455-503W-8
		7/8	3/4	3-1/2	.030	455-513-5	455-513W-5	455-513-8	455-513W-8
		1-1/2	3/4	4	.030	453-503-5	453-503W-5	453-503-8	453-503W-8
		1-5/8	3/4	4	.030	453-513-5	453-513W-5	453-513-8	453-513W-8
		3	3/4	6	.030	454-453-5	454-453W-5	454-453-8	454-453W-8
	1	1-1/2	1	4	.030	453-523-5	453-523W-5	453-523-8	453-523W-8
		3	1	6	.045	454-474-5	454-474W-5	454-474-8	454-474W-8

We manufacture a full range of cutting diameters. Please call for availability.



HY5 PRO+ SQUARE ENDMILLS

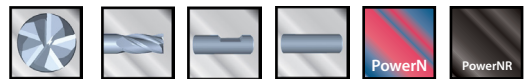

5 Flutes • Coated • With and without Flat

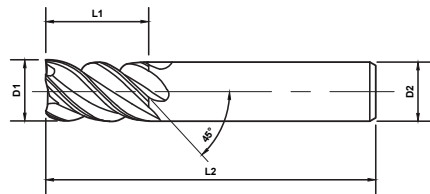

- Pro+ performance A-Gr-SiV submicron grain carbide
- Unique 45° 5 flute design, superior coating and edge quality
- Best performance and finish on wide range of materials- Specially on stainless steel, titanium and other exotic materials

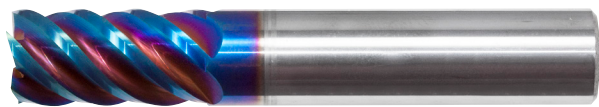

- Stub, Series 458, PowerN
- Standard, Series 456, PowerN
- Long, Series 457, PowerN

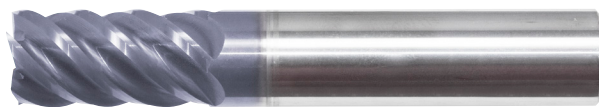

- Stub, Series 458, PowerNR
- Standard, Series 456, PowerNR
- Long, Series 457, PowerNR



Length Key (K)

Standard
 Stub
 Long

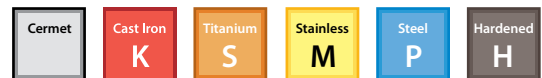

K	OD	LOC	SHK	OAL	PowerN		PowerNR	
					No Flat	With Flat	No Flat	With Flat
1/8	D1	1/4	1/8	1-1/2	458-004-5	-	458-004-8	-
		1/2	1/8	1-1/2	456-002-5	-	456-002-8	-
3/16	D1	3/8	3/16	2	458-006-5	-	458-006-8	-
		9/16	3/16	2	456-006-5	-	456-006-8	-
1/4	D1	1/2	1/4	2	458-010-5	458-010W-5	458-010-8	458-010W-8
		3/4	1/4	2-1/2	456-010-5	456-010W-5	456-010-8	456-010W-8
		1-1/8	1/4	3	457-002-5	457-002W-5	457-002-8	457-002W-8
5/16	D1	1/2	5/16	2	458-012-5	458-012W-5	458-012-8	458-012W-8
		13/16	5/16	2-1/2	456-012-5	456-012W-5	456-012-8	456-012W-8
		1-1/8	5/16	3	457-004-5	457-004W-5	457-004-8	457-004W-8
3/8	D1	5/8	3/8	2	458-014-5	458-014W-5	458-014-8	458-014W-8
		7/8	3/8	2-1/2	456-016-5	456-016W-5	456-016-8	456-016W-8
		1-1/8	3/8	3	457-006-5	457-006W-5	457-006-8	457-006W-8
1/2	D1	5/8	1/2	2-1/2	458-018-5	458-018W-5	458-018-8	458-018W-8
		1	1/2	3	456-022-5	456-022W-5	456-022-8	456-022W-8
		1-1/4	1/2	3	456-024-5	456-024W-5	456-024-8	456-024W-8
		2	1/2	4	457-008-5	457-008W-5	457-008-8	457-008W-8
5/8	D1	3/4	5/8	3	458-020-5	458-020W-5	458-020-8	458-020W-8
		1-1/4	5/8	3-1/2	456-028-5	456-028W-5	456-028-8	456-028W-8
3/4	D1	1	3/4	3	458-024-5	458-024W-5	458-024-8	458-024W-8
		1-1/2	3/4	4	456-030-5	456-030W-5	456-030-8	456-030W-8
1	D1	1-1/2	1	4	456-034-5	456-034W-5	456-034-8	456-034W-8
		3	1	6	457-020-5	457-020W-5	457-020-8	457-020W-8

We manufacture a full range of cutting diameters. Please call for availability.

HY5 PRO+ CORNER RADIUS

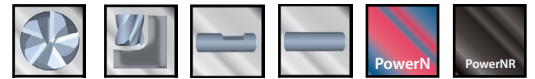

5 Flutes • Coated • With and without Flat

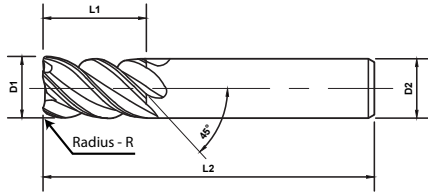

- Pro+ performance A-Gr-SiV submicron grain carbide
- Unique 45° 5 flute design, superior coating and edge quality
- Best performance and finish on wide range of materials- Specially on stainless steel, titanium and other exotic materials

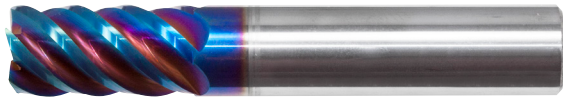

- Stub, Series 458, PowerN
- Standard, Series 456, PowerN
- Long, Series 457, PowerN

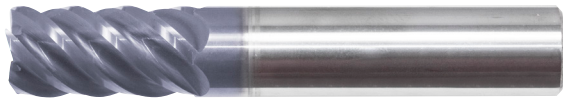

- Stub, Series 458, PowerNR
- Standard, Series 456, PowerNR
- Long, Series 457, PowerNR



Pro+ Performance Endmills

Length Key (K)

Standard Stub Long



K	OD	LOC	SHK	OAL	Radius	PowerN		PowerNR	
	D1	L1	D2	L2	R	No Flat	With Flat	No Flat	With Flat
1/8	1/8	1/4	1/8	1-1/2	.020	458-402-5	-	458-402-8	-
	3/16	3/8	3/16	2	.020	458-422-5	-	458-422-8	-
1/4	1/4	3/4	1/4	2-1/2	.015	456-421-5	456-421W-5	456-421-8	456-421W-8
		1-1/8	1/4	3	.020	457-402-5	457-402W-5	457-402-8	457-402W-8
5/16	5/16	1/2	5/16	2	.030	458-453-5	458-453W-5	458-453-8	458-453W-8
		13/16	5/16	2-1/2	.030	456-433-5	456-433W-5	456-433-8	456-433W-8
3/8	3/8	5/8	3/8	2	.030	458-463-5	458-463W-5	458-463-8	458-463W-8
		7/8	3/8	2-1/2	.030	456-443-5	456-443W-5	456-443-8	456-443W-8
		1-1/8	3/8	3	.030	457-423-5	457-423W-5	457-423-8	457-423W-8
1/2	1/2	5/8	1/2	2-1/2	.030	458-483-5	458-483W-5	458-483-8	458-483W-8
		1	1/2	3	.030	456-463-5	456-463W-5	456-463-8	456-463W-8
		1-1/4	1/2	3	.030	456-473-5	456-473W-5	456-473-8	456-473W-8
		2	1/2	4	.030	457-433-5	457-433W-5	457-433-8	457-433W-8
5/8	5/8	3/4	5/8	3	.030	458-493-5	458-493W-5	458-493-8	458-493W-8
		1-1/4	5/8	3-1/2	.030	456-493-5	456-493W-5	456-493-8	456-493W-8
		2-1/4	5/8	5	.030	457-443-5	457-443W-5	457-443-8	457-443W-8
3/4	3/4	1	3/4	3	.030	458-503-5	458-503W-5	458-503-8	458-503W-8
		7/8	3/4	3-1/2	.030	458-513-5	458-513W-5	458-513-8	458-513W-8
		2-1/4	3/4	5	.030	457-453-5	457-453W-5	457-453-8	457-453W-8
		3	3/4	6	.030	457-463-5	457-463W-5	457-463-8	457-463W-8
		4	3/4	6	.030	457-473-5	457-473W-5	457-473-8	457-473W-8
1	1	1-1/2	1	4	.045	456-524-5	456-524W-5	456-524-8	456-524W-8
		2-1/4	1	5	.045	457-484-5	457-484W-5	457-484-8	457-484W-8
		3	1	6	.045	457-494-5	457-494W-5	457-494-8	457-494W-8

We manufacture a full range of cutting diameters and endcut radii. Please call for availability.

F45 PRO+ SQUARE ENDMILLS

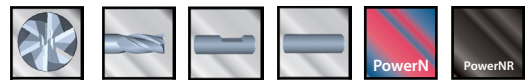

6 Flutes • Coated

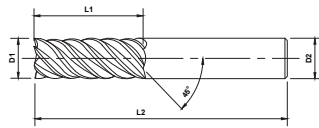

- Pro+ performance A-Gr-SiV submicron grain carbide
- Unique 45° 6 flute design, superior coating and edge quality
- Best performance and finish on wide range of materials- Specially on stainless steel, titanium and other exotic materials
- MAP certified quality

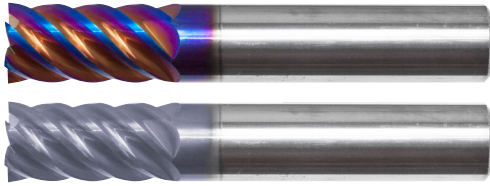

Standard, Series 459, PowerN

Standard, Series 459, PowerNR



Length Key (K)

Standard Stub Long



	OD	LOC	SHK	OAL	PowerN	PowerNR	
K	D1	L1	D2	L2			
Standard	3/16	5/8	3/16	2	459-002-5	459-002-8	
	1/4	3/4	1/4	2-1/2	459-004-5	459-004-8	
	5/16	7/8	5/16	2-1/2	459-006-5	459-006-8	
	3/8	1	3/8	2-1/2	459-008-5	459-008-8	
	7/16	1	7/16	2-1/2	459-010-5	459-010-8	
	1/2	1	1/2	3	459-012-5	459-012-8	
	9/16	1	9/16	3	459-014-5	459-014-8	
	5/8	1-1/4	5/8	3-1/2	459-016-5	459-016-8	
	3/4	1-1/2	3/4	4	459-018-5	459-018-8	
	7/8	1-1/2	7/8	4	459-020-5	459-020-8	
	Stub	1	1-1/2	1	4	459-022-5	459-022-8
			2-1/4	1	5	459-024-5	459-024-8

We manufacture a full range of cutting diameters. Please call for availability.

F45 PRO+ CORNER RADIUS

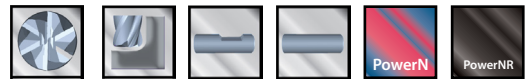

6 Flutes • Coated

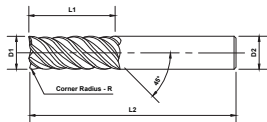

- Pro+ Performance A-Gr-SiV submicron grain carbide
- Unique 45° 6 flute design, superior coating and edge quality
- Best performance and finish on wide range of materials- Specially on stainless steel, titanium and other exotic materials
- MAP certified quality

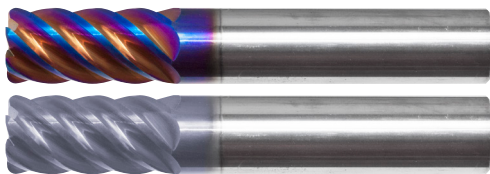

Standard, Series 459, PowerN

Standard, Series 459, PowerNR



	OD	LOC	SHK	OAL	Radius	PowerN	PowerNR	
K	D1	L1	D2	L2	R			
Standard	1/4	3/4	1/4	2-1/2	.010	459-200-5	459-200-8	
	5/16	7/8	5/16	2-1/2	.012	459-210-5	459-210-8	
	3/8	1	3/8	2-1/2	.012	459-220-5	459-220-8	
	7/16	1	7/16	2-1/2	.015	459-231-5	459-231-8	
	1/2	1	1/2	3	.015	459-241-5	459-241-8	
	9/16	1	9/16	3	.020	459-252-5	459-252-8	
	5/8	1-1/4	5/8	3-1/2	.020	459-262-5	459-262-8	
	3/4	1-1/2	3/4	4	.030	459-273-5	459-273-8	
	7/8	1-1/2	7/8	4	.030	459-283-5	459-283-8	
	Stub	1	1-1/2	1	4	.030	459-293-5	459-293-8

We manufacture a full range of cutting diameters and endcut radii. Please call for availability.

V7 PRO+ ENDMILLS

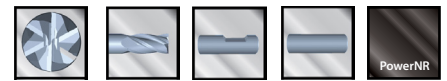

Pro+ Performance Endmills

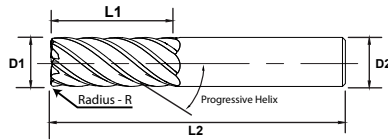

- Progressive Helix, Non-center cutting design
- High Performance, Eccentric relief
- Designed for HEM programs (High Efficiency Milling)
- Broad spectrum compatibility, including titanium alloys



Standard, Series 449, PowerNR



Length Key (K)

Standard
 Stub
 Long

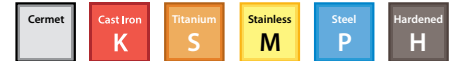

K	OD	LOC	SHK	OAL	Square	.015 Corner Radius	.020 Corner Radius	.030 Corner Radius	.060 Corner Radius
	D1	L1	D2	L2					
1/4	1/4	3/8	1/4	2	449-002-8	449-401-8	449-402-8	449-403-8	-
		1/2	1/4	2	449-004-8	449-411-8	449-412-8	449-413-8	-
		3/4	1/4	2-1/2	449-006-8	449-421-8	449-422-8	449-423-8	-
		1	1/4	3	449-008-8	449-431-8	449-432-8	449-433-8	-
		1-1/4	1/4	3	449-010-8	449-441-8	449-442-8	449-443-8	-
5/16	5/16	7/16	5/16	2	449-012-8	449-451-8	449-452-8	449-453-8	-
		3/4	5/16	2-1/2	449-014-8	449-461-8	449-462-8	449-463-8	-
		1	5/16	3	449-016-8	449-471-8	449-472-8	449-473-8	-
3/8	3/8	1/2	3/8	2	449-018-8	449-481-8	449-482-8	449-483-8	449-485-8
		3/4	3/8	2-1/2	449-020-8	449-491-8	449-492-8	449-493-8	449-495-8
		1	3/8	2-1/2	449-022-8	449-501-8	449-502-8	449-503-8	449-505-8
		1-1/2	3/8	3-1/2	449-024-8	449-511-8	449-512-8	449-513-8	449-515-8
		2	3/8	4	449-026-8	449-521-8	449-522-8	449-523-8	449-525-8
1/2	1/2	5/8	1/2	2-1/2	449-028-8	449-531-8	449-532-8	449-533-8	449-535-8
		1	1/2	3	449-030-8	449-541-8	449-542-8	449-543-8	449-545-8
		1-1/4	1/2	3	449-032-8	449-551-8	449-552-8	449-553-8	449-555-8
		1-5/8	1/2	4	449-034-8	449-561-8	449-562-8	449-563-8	449-565-8
		2	1/2	4	449-036-8	449-571-8	449-572-8	449-573-8	449-575-8
		2-1/2	1/2	5	449-038-8	449-581-8	449-582-8	449-583-8	449-585-8
5/8	5/8	3-1/8	1/2	6	449-040-8	449-591-8	449-592-8	449-593-8	449-595-8
		3/4	5/8	3	449-042-8	449-601-8	449-602-8	449-603-8	449-605-8
		1-1/4	5/8	3-1/2	449-044-8	449-611-8	449-612-8	449-613-8	449-615-8
		1-5/8	5/8	4	449-046-8	449-621-8	449-622-8	449-623-8	449-625-8
		2-1/8	5/8	4	449-048-8	449-631-8	449-632-8	449-633-8	449-635-8
3/4	3/4	1	3/4	3	449-050-8	449-641-8	449-642-8	449-643-8	449-645-8
		1-1/4	3/4	3-1/2	449-052-8	449-651-8	449-652-8	449-653-8	449-655-8
		1-5/8	3/4	4	449-054-8	449-661-8	449-662-8	449-663-8	449-665-8
		2-1/4	3/4	5	449-056-8	449-671-8	449-672-8	449-673-8	449-675-8
1	1	3-1/4	3/4	6	449-058-8	449-681-8	449-682-8	449-683-8	449-685-8
		1-1/2	1	4	449-060-8	449-691-8	449-692-8	449-693-8	449-695-8
		2	1	5	449-062-8	449-701-8	449-702-8	449-703-8	449-705-8
		3-1/4	1	6	449-064-8	449-711-8	449-712-8	449-713-8	449-715-8

Available with Weldon Flat - Add **W** to part ID for Weldon flat 449-XXX**W**-8

HIGH PERFORMANCE ROUTERS

SPECIALY SELECTED









- **Routers**
- **OFX ("O" Flute Extreme)**
- **CRFP Routers with CVD Diamond Coating**









PowerRD Real Diamond Coating

Our PowerRD Coating is our hardest coating at approximately 8,000 Vickers. PowerRD is a perfect selection for machining aluminum, graphite, and green ceramics.

TABLE OF CONTENTS

	2 Flute Compression Routers114	Fiberglass	Graphite	Composite	Metal Matrix	Carbon Fiber	Honeycomb
	2 Flute Compression Chipbreaker Routers115	Fiberglass	Graphite	Composite	Metal Matrix	Carbon Fiber	Honeycomb
	3 Flute Compression Routers116	Fiberglass	Graphite	Composite	Metal Matrix	Carbon Fiber	Honeycomb
	4 Flute Combination Compression Routers117	Fiberglass	Graphite	Composite	Metal Matrix	Carbon Fiber	Honeycomb
	4 Flute Compression Routers118	Fiberglass	Graphite	Composite	Metal Matrix	Carbon Fiber	Honeycomb
	4 Flute Fiberglass Mill End Routers119	Fiberglass					
	Fiberglass and Composite Finishers120	Fiberglass					
	OFX O-Flute Xtreme Routers121					Plastics	
	CVD Nano Crystalline Routers122	CRFP	Graphite	Composite		Carbon Fiber	Honeycomb

Features Legend

	2 Flutes		Multi-Flute
	3 Flutes		Plain Shank
	4 Flutes		Corner Radius
	6 Flutes		

Coatings Legend

	PowerA Coating
	PowerZ Coating
	PowerN Coating
	PowerRD Coating

Mastercut's Superior Carbide Blend – A-Gr-SiV (Active Grain Sized Volume)

Our superior tungsten carbide gives you the ability to be *aggressive* when you need to be. Growth inhibitors in our sub-micron carbide blanks maintain the most consistent grain size available, giving you superior hardness AND toughness.

Please contact us for our full line of metric products.

2 FLUTE COMPRESSION



2 Flutes • Coated and Uncoated

- High Performance A-Gr-SiV submicron grain carbide
- Unique right and left fluting, controls finish on both sides of work-piece
- Effective for wide range of materials
- MAP certified quality

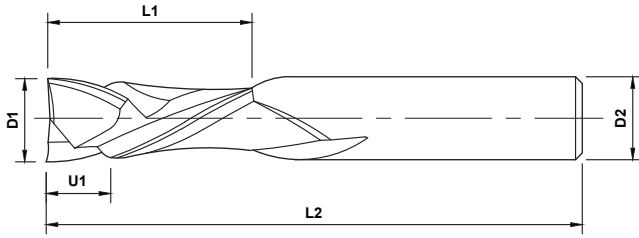

Standard, Series 810



OD	LOC	Upcut	SHK	OAL	Uncoated		PowerA		PowerZ	
					Standard	Mortise	Standard	Mortise	Standard	Mortise
D1	L1	U1	D2	L2						
1/4	7/8	.188	1/4	2-1/2	-	810-202	-	810-202-1	-	810-202-4
	7/8	.2756	1/4	2-1/2	810-030	-	810-030-1	-	810-030-4	-
	7/8	.385	1/4	2-1/2	810-020	-	810-020-1	-	810-020-4	-
3/8	7/8	.188	3/8	3	-	810-204	-	810-204-1	-	810-204-4
	1	.3543	1/2	3	810-034	-	810-034-1	-	810-034-4	-
	1	.440	1/2	3	810-024	-	810-024-1	-	810-024-4	-
	1-1/8	.188	3/8	3	-	810-210	-	810-210-1	-	810-210-4
	1-1/8	.188	3/8	3	-	810-212*	-	810-212-1*	-	810-212-4*
	1-1/8	.3543	1/2	3	810-026	-	810-026-1	-	810-026-4	-
	1-1/8	.495	3/8	3	810-002	-	810-002-1	-	810-002-4	-
	1-1/4	.3543	3/8	3	810-032	-	810-032-1	-	810-032-4	-
1/2	7/8	.200	1/2	3	-	810-206	-	810-206-1	-	810-206-4
	1	.440	1/2	3	810-004	-	810-004-1	-	810-004-4	-
	1-1/8	.495	1/2	3	810-006	-	810-006-1	-	810-006-4	-
	1-1/4	.250	1/2	3	-	810-214	-	810-214-1	-	810-214-4
	1-5/16	.577	1/2	3	810-022	-	810-022-1	-	810-022-4	-
	1-3/8	.200	1/2	3-1/2	-	810-208	-	810-208-1	-	810-208-4
	1-3/8	.605	1/2	3-1/2	810-008	-	810-008-1	-	810-008-4	-
	1-5/8	.433	1/2	3-1/2	810-028	-	810-028-1	-	810-028-4	-
	1-5/8	.715	1/2	4	810-010	-	810-010-1	-	810-010-4	-
	1-5/8	.715	1/2	4	810-012*	-	810-012-1*	-	810-012-4*	-
5/8	2-1/4	.990	5/8	5	810-014	-	810-014-1	-	810-014-4	-
3/4	1-7/8	.825	3/4	4	810-016	-	810-016-1	-	810-016-4	-
	2-1/2	1.10	3/4	5	810-018	-	810-018-1	-		

* Left Hand Cut

PowerNR Coating Available

2 FLUTE COMPRESSION



CHIPBREAKER FINISHER

2 Flutes • Coated and Uncoated

- High Performance A-Gr-SiV submicron grain carbide
- Unique right and left fluting, controls finish on both sides of work-piece
- Effective for wide range of materials
- MAP certified quality

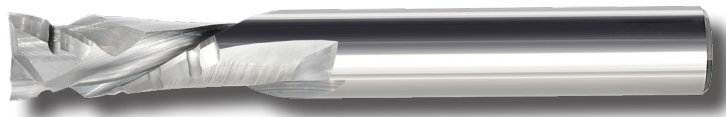
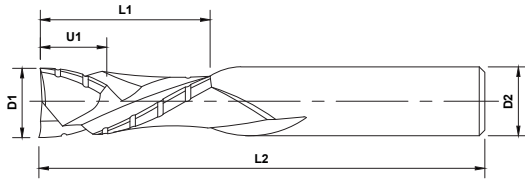

Standard, Series 810

High Performance Routers



OD	LOC	Upcut	SHK	OAL	Uncoated	PowerA	PowerZ
D1	L1	U1	D2	L2	Standard	Standard	Standard
3/8	7/8	.385	3/8	3	810-302	810-302-1	810-302-4
	1-1/8	.495	3/8	3	810-304	810-304-1	810-304-4
1/2	7/8	.385	1/2	3	810-318	810-318-1	810-318-4
	1	.440	1/2	3	810-306	810-306-1	810-306-4
	1-1/8	.495	1/2	3	810-308	810-308-1	810-308-4
	1-3/8	.605	1/2	3-1/2	810-310	810-310-1	810-310-4
	1-5/8	.715	1/2	4	810-312	810-312-1	810-312-4
5/8	2-1/4	.990	5/8	5	810-314	810-314-1	810-314-4
3/4	1-7/8	.825	3/4	4	810-316	810-316-1	810-316-4

PowerNR Coating Available

3 FLUTE COMPRESSION



3 Flutes • Coated and Uncoated

- High Performance A-Gr-SiV submicron grain carbide
- Unique right and left fluting, controls finish on both sides of work-piece
- Effective for wide range of materials
- MAP certified quality

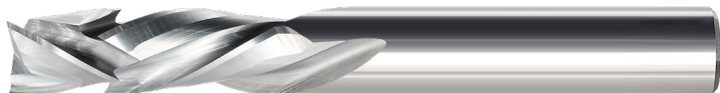
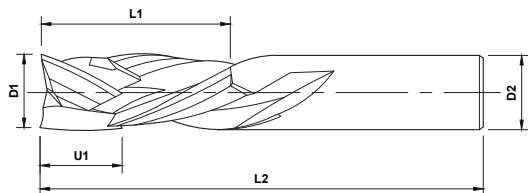

Standard, Series 818



OD	LOC	Upcut	SHK	OAL	Uncoated		PowerA		PowerZ	
					Standard	Mortise	Standard	Mortise	Standard	Mortise
3/8	7/8	.200	3/8	3	-	818-202	-	818-202-1	-	818-202-4
	1-1/8	.495	3/8	3	818-002	-	818-002-1	-	818-002-4	-
1/2	7/8	.200	1/2	3	-	818-204	-	818-204-1	-	818-204-4
	1-1/8	.495	1/2	3	818-004	-	818-004-1	-	818-004-4	-
	1-3/8	.200	1/2	3-1/2	-	818-206	-	818-206-1	-	818-206-4
	1-5/8	.715	1/2	3-1/2	818-006	-	818-006-1	-	818-006-4	-
3/4	2	.200	3/4	4	-	818-208	-	818-208-1	-	818-208-4
	2	.880	3/4	4	818-008	-	818-008-1	-	818-008-4	-

PowerNR Coating Available

4 FLUTE COMBINATION COMPRESSION



4 Flutes • Coated and Uncoated

- High Performance A-Gr-SiV submicron grain carbide
- Unique right and left fluting, controls finish on both sides of work-piece
- Effective for wide range of materials
- MAP certified quality

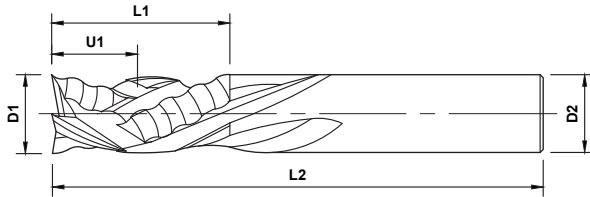

Standard, Series 820

High Performance Routers



OD	LOC	Upcut	SHK	OAL	Uncoated	PowerA	PowerZ
D1	L1	U1	D2	L2	Standard	Standard	Standard
1/2	1	.440	1/2	3	820-202	820-202-1	820-202-4
	1-1/8	.495	1/2	3	820-204	820-204-1	820-204-4
	1-3/8	.605	1/2	3-1/2	820-206	820-206-1	820-206-4
	1-5/8	.715	1/2	4	820-208	820-208-1	820-208-4
5/8	2-1/4	.990	5/8	5	820-210	820-210-1	820-210-4
3/4	1-7/8	.825	3/4	4	820-212	820-212-1	820-212-4
	2-1/2	1.100	3/4	5	820-214	820-214-1	820-214-4

PowerNR Coating Available

4 FLUTE COMPRESSION



4 Flutes • Coated and Uncoated

- High Performance A-Gr-SiV submicron grain carbide
- Unique right and left fluting, controls finish on both sides of work-piece
- Effective for wide range of materials
- MAP certified quality

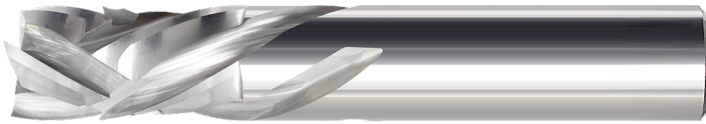
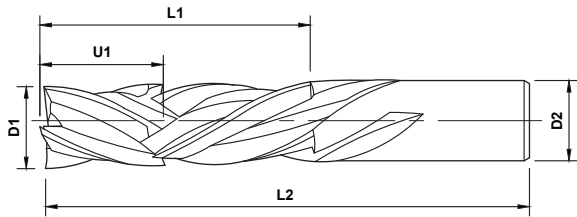

Standard, Series 821



OD	LOC	Upcut	SHK	OAL	Uncoated		PowerA		PowerZ	
					Standard	Mortise	Standard	Mortise	Standard	Mortise
1/2	7/8	.200	1/2	3	-	821-102	-	821-102-1	-	821-102-4
	1	.440	1/2	3	821-002	-	821-002-1	-	821-002-4	-
	1-1/8	.495	1/2	3	821-004	-	821-004-1	-	821-004-4	-
	1-3/8	.200	1/2	3-1/2	-	821-104	-	821-104-1	-	821-104-4
	1-3/8	.605	1/2	3-1/2	821-006	-	821-006-1	-	821-006-4	-
	1-5/8	.715	1/2	4	821-008	-	821-008-1	-	821-008-4	-
5/8	2-1/4	.990	5/8	5	821-010	-	821-010-1	-	821-010-4	-
3/4	1-7/8	.825	3/4	4	821-012	-	821-012-1	-	821-012-4	-
	2-1/2	1.100	3/4	5	821-014	-	821-014-1	-	821-014-4	-

4 FLUTE FIBERGLASS MILL END ROUTER



4 Flutes • Coated and Uncoated

- High Performance A-Gr-SiV submicron grain carbide
- design for superb edge quality
- MAP certified quality

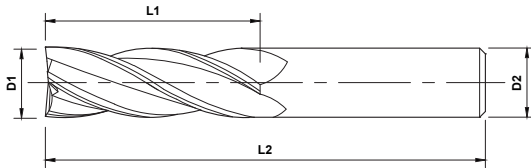

FIBERGLASS APPLICATIONS

Note: Please see the bur section of our catalog for additional fiberglass router selections.



Standard, Series 819

High Performance Routers

Fiberglass

OD	LOC	SHK	OAL	Uncoated		PowerA		PowerZ	
D1	L1	D2	L2	Upcut	Downcut	Upcut	Downcut	Upcut	Downcut
3/8	5/8	3/8	3	819-202	819-302	819-202-1	819-302-1	819-202-4	819-302-4
	1-1/8	3/8	3	819-204	819-304	819-204-1	819-304-1	819-204-4	819-304-4
1/2	5/8	1/2	3-1/2	819-206	819-306	819-206-1	819-306-1	819-206-4	819-306-4
	1-1/8	1/2	3-1/2	819-208	819-308	819-208-1	819-308-1	819-208-4	819-308-4

FIBERGLASS AND COMPOSITE FINISHERS



0 Flute, 2 Flute, and 2/5 Aramid Style

- High Performance A-Gr-SiV submicron grain carbide
- Fast removal and superb finish in fiberglass
- MAP certified quality

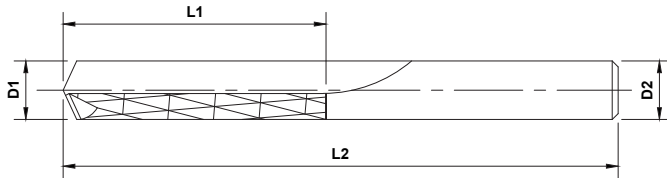

FIBERGLASS APPLICATIONS

Note: Please see the bur section of our catalog for additional fiberglass router selections.



Standard, Series 822 - 0 Flute



Standard, Series 822 - 2 Flute



Standard, Series 822 - 2/5 Aramid

Fiberglass

OD	LOC	SHK	OAL	Standard	Standard	Aramid
D1	L1	D2	L2	0 Flute	2 Flute	2/5 Flute
1/4	3/4	1/4	2-1/2	822-102	822-104	822-106
	1	1/4	3	822-108	-	-
3/8	7/8	3/8	2-1/2	822-110	822-112	822-114
1/2	1	1/2	3	822-116	822-118	822-120

OFX O-FLUTE EXTREME ROUTERS



High Polish • Upcut and Downcut

- High Performance A-Gr-SiV submicron grain carbide
- Polished flute for superior edge quality
- MAP certified quality
- Great on acrylics

OFX

Please contact us for
our full line of
router products

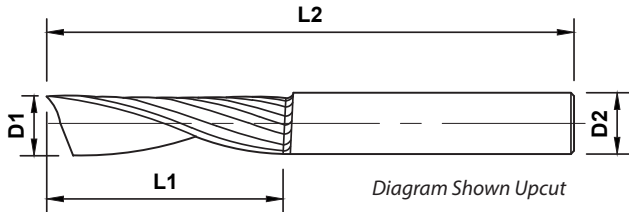

Standard, Series 823
Photo Shown Downcut



Standard, Series 823, PowerN
Photo Shown Downcut



OD	LOC	SHK	OAL	Upcut		Downcut	
D1	L1	D2	L2	Uncoated	PowerN	Uncoated	PowerN
1/16	1/4	1/8	2	823-002	823-002-5	823-102	823-102-5
1/8	1/4	1/8	2	823-004	823-004-5	823-104	823-104-5
	1/4	1/4	2	823-006	823-006-5	823-106	823-106-5
	1/2	1/8	2	823-008	823-008-5	823-108	823-108-5
	1/2	1/4	2	823-010	823-010-5	823-110	823-110-5
5/32	9/16	1/4	2	823-012	823-012-5	823-112	823-112-5
3/16	3/8	3/16	2	823-014	823-014-5	823-114	823-114-5
	5/8	3/16	2	823-016	823-016-5	823-116	823-116-5
	3/8	1/4	2	823-018	823-018-5	823-118	823-118-5
	1/2	1/4	2	823-020	823-020-5	823-120	823-120-5
	5/8	1/4	2	823-022	823-022-5	823-122	823-122-5
	7/8	1/4	2-1/2	823-042	823-042-5	823-142	823-142-5
	1-1/4	1/4	3	823-040	823-040-5	823-140	823-140-5
7/32	3/4	1/4	2-1/2	823-024	823-024-5	823-124	823-124-5
1/4	5/8	1/4	2	823-026	823-026-5	823-126	823-126-5
	3/4	1/4	2-1/2	823-028	823-028-5	823-128	823-128-5
	1-1/4	1/4	3	823-030	823-030-5	823-130	823-130-5
	1-1/2	1/4	3	823-044	823-044-5	823-144	823-144-5
3/8	1-1/8	3/8	3	823-032	823-032-5	823-132	823-132-5
1/2	1	1/2	3	823-034	823-034-5	823-134	823-134-5
	2	1/2	4	823-036	823-036-5	823-136	823-136-5

FINE PITCH NICKED NANO ROUTERS



6 -16 Flutes • Diamond Coated • Fine Pitched Nicked

- High Performance A-Gr-SiV submicron grain carbide
- Excellent performance on carbon graphite and carbon fiber panels

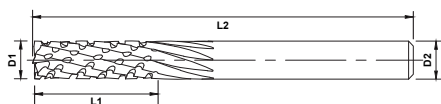

CVD Real Diamond Coated



Standard, Series 824

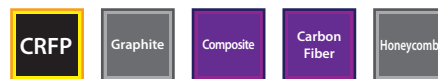

OD	LOC	SHK	OAL	Flutes	PowerRD		
					Plain End	Bur End	Mill End
1/8	1/4	1/8	1-1/2	6	824-002-7	824-102-7	824-202-7
	3/8	1/8	1-1/2	6	824-004-7	824-104-7	824-204-7
	1/2	1/8	1-1/2	8	824-006-7	824-106-7	824-206-7
3/16	3/8	3/16	2	6	824-008-7	824-108-7	824-208-7
	9/16	3/16	2	6	824-010-7	824-110-7	824-210-7
	3/4	3/16	2	8	824-012-7	824-112-7	824-212-7
1/4	1/2	1/4	2-1/2	8	824-014-7	824-114-7	824-214-7
	3/4	1/4	2-1/2	10	824-016-7	824-116-7	824-216-7
	1	1/4	3	10	824-018-7	824-118-7	824-218-7
	1-1/2	1/4	4	12	824-020-7	824-120-7	824-220-7
5/16	1	5/16	2-1/2	10	824-022-7	824-122-7	824-222-7
3/8	3/4	3/8	2-1/2	12	824-024-7	824-124-7	824-224-7
	1-1/8	3/8	3	12	824-026-7	824-126-7	824-226-7
	1-1/2	3/8	4	12	824-028-7	824-128-7	824-228-7
	2	3/8	4	12	824-030-7	824-130-7	824-230-7
1/2	1	1/2	3	14	824-032-7	824-132-7	824-232-7
	2	1/2	4	16	824-034-7	824-134-7	824-234-7

HERRINGBONE COMPOSITE SURFACE FINISHER



4 Flutes • Diamond Coated

- High Performance A-Gr-SiV submicron grain carbide
- Excellent performance on carbon graphite and carbon fiber panels

CVD Real Diamond Coated

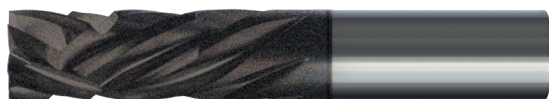

Standard, Series 825

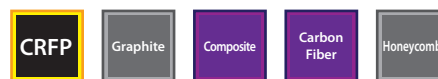

OD	LOC	SHK	OAL	PowerRD
D1	L1	D2	L2	
1/8	3/8	1/8	1-1/2	825-002-7
1/4	3/4	1/4	2-1/2	825-004-7
3/8	1-1/8	3/8	3	825-006-7
1/2	1-1/8	1/2	3	825-008-7

COMPOSITE ROUGHER/SEMI-FINISHER

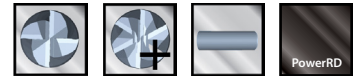

4-8 Flutes • Diamond Coated

- High Performance A-Gr-SiV submicron grain carbide
- Excellent performance on carbon graphite and carbon fiber panels

CVD Real Diamond Coated



Standard, Series 826



OD	LOC	SHK	OAL	Flutes	PowerRD
D1	L1	D2	L2		
15/64	3/4	1/4	2-1/2	4	826-002-7
1/4	1/2	1/4	2-1/2	4	826-004-7
	3/4	1/4	2-1/2	4	826-006-7
11/32	1-1/8	3/8	3	6	826-008-7
23/64	1-1/8	3/8	3	6	826-010-7
3/8	3/4	3/8	3	6	826-012-7
	1-1/2	3/8	3	6	826-014-7
7/16	1-1/2	1/2	3	8	826-016-7
31/64	1-1/2	1/2	3	8	826-018-7
1/2	1	1/2	3	8	826-020-7
	1-1/2	1/2	3	8	826-022-7

COMPOSITE FINISHER



8-14 Flutes • Diamond Coated

- High Performance A-Gr-SiV submicron grain carbide
- Excellent performance on carbon graphite and carbon fiber panels
- MAP certified quality

CVD Real Diamond Coated



Standard, Series 827



OD	LOC	SHK	OAL	Flutes	PowerRD
D1	L1	D2	L2		
1/4	3/4	1/4	2-1/2	8	827-002-7
	1	1/4	3	8	827-004-7
3/8	1-1/8	3/8	3	12	827-006-7
	1-1/2	3/8	3	12	827-008-7
1/2	1-1/2	1/2	4	14	827-010-7
	2	1/2	4	14	827-012-7

CARBIDE DRILLS



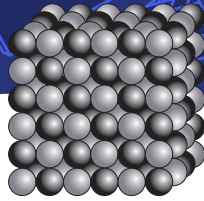







- **Jobber Drills**
- **Stub Drills**
- **Straight Flute Drills**
- **Spade Drills**
- **Spotting Drills**
- **Drill and Countersink**
- **Multiple Flute Countersinks**
- **Chamfer Tools**



Mastercut's Superior Carbide Blend – *A-Gr-SiV* (Active Grain Sized Volume)

Our superior tungsten carbide gives you the ability to be *aggressive* when you need to be. Growth inhibitors in our submicron carbide blanks maintain the most consistent grain size available, giving you superior hardness AND toughness.

TABLE OF CONTENTS

	Jobber Drills	126	Cermet	Hardened H	Cast Iron K	Titanium S	Non-Ferrous N	Stainless M	Steel P
	Stub Drills.	131	Cermet	Hardened H	Cast Iron K	Titanium S	Non-Ferrous N	Stainless M	Steel P
	Straight Flute Drills	135	Cermet	Hardened H	Cast Iron K	Titanium S	Non-Ferrous N	Stainless M	Steel P
	Spade Drills.	136	Cermet	Hardened H	Cast Iron K	Titanium S	Non-Ferrous N	Stainless M	Steel P
	NC Spotting Drills	137	Cermet	Hardened H	Cast Iron K	Titanium S	Non-Ferrous N	Stainless M	Steel P
	Drill and Countersink/ Center Drills	137	Cermet	Hardened H	Cast Iron K	Titanium S	Non-Ferrous N	Stainless M	Steel P
	Countersinks, Single Flute	138			Cast Iron K	Titanium S	Non-Ferrous N	Stainless M	Steel P
	Countersinks, Three Flute	138			Cast Iron K	Titanium S	Non-Ferrous N	Stainless M	Steel P
	Countersinks, Six Flute	139			Cast Iron K	Titanium S	Non-Ferrous N	Stainless M	Steel P
	Chamfer Tools	139	Hardened H	Cast Iron K	Titanium S	Non-Ferrous N	Stainless M	Steel P	







Carbide Drills

Mastercut's Superior Carbide Blend – A-Gr-SiV (Active Grain Sized Volume)

Our superior tungsten carbide gives you the ability to be *aggressive* when you need to be. Growth inhibitors in our sub-micron carbide blanks maintain the most consistent grain size available, giving you superior hardness AND toughness.

See Reamers and Threadmills pages for additional tools.

Features Legend

	2 Flutes		6 Flutes
	3 Flutes		Plain shank
	4 Flutes		Double End Square

Coatings Legend

	PowerA Coating
---	----------------

Please contact us for our full line of metric products.

JOBBER DRILLS



2 Flute 118° Four Facet Point • 3 Flute 130° High Performance Point • Coated and Uncoated

- Genuine A-Gr-SiV submicron grain carbide
- Proven, versatile performance
- MAP certified quality

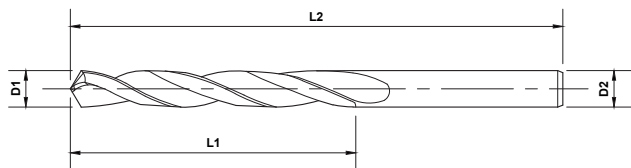

Series 601 - 2 Flute



Series 601 - 3 Flute

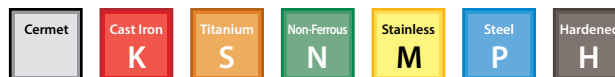

OD	LOC	SHK	OAL	Wire	Uncoated		PowerA	
					2 Flute	3 Flute	2 Flute	3 Flute
D1	L1	D2	L2	Letter				
.0280	5/16	.0280	1-1/4	70	601-002*	-	601-002-1*	-
.0292	5/16	.0292	1-1/4	69	601-004*	-	601-004-1*	-
.0310	5/16	.0310	1-1/4	68	601-006*	-	601-006-1*	-
1/32	5/16	1/32	1-1/4		601-008*	-	601-008-1*	-
.0320	5/16	.0320	1-1/4	67	601-010*	-	601-010-1*	-
.0330	5/16	.0330	1-1/4	66	601-012*	-	601-012-1*	-
.0350	5/8	.0350	1-3/8	65	601-014*	-	601-014-1*	-
.0360	5/8	.0360	1-3/8	64	601-016*	-	601-016-1*	-
.0370	5/8	.0370	1-3/8	63	601-018*	-	601-018-1*	-
.0380	5/8	.0380	1-3/8	62	601-020*	-	601-020-1*	-
.0390	5/8	.0390	1-3/8	61	601-022*	-	601-022-1*	-
.0394	5/8	.0394	1-1/2		601-024*	-	601-024-1*	-
.0400	3/4	.0400	1-1/2	60	601-026*	-	601-026-1*	-
.0410	3/4	.0410	1-1/2	59	601-028*	-	601-028-1*	-
.0420	3/4	.0420	1-1/2	58	601-030*	-	601-030-1*	-
.0430	3/4	.0430	1-1/2	57	601-032*	-	601-032-1*	-
.0465	3/4	.0465	1-1/2	56	601-034*	-	601-034-1*	-
3/64	3/4	3/64	1-1/2		601-036*	-	601-036-1*	-
.0520	3/4	.0520	1-1/2	55	601-038*	-	601-038-1*	-
.0550	3/4	.0550	1-1/2	54	601-040*	-	601-040-1*	-
.0591	3/4	.0591	1-1/2		601-042*	-	601-042-1*	-
.0595	3/4	.0595	1-1/2	53	601-044*	-	601-044-1*	-
1/16	3/4	1/16	1-1/2		601-046	-	601-046-1	-
.0635	3/4	.0635	1-1/2	52	601-048	-	601-048-1	-

* 135° Point

JOBBER DRILLS

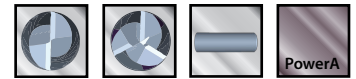

2 Flute 118° Four Facet Point • 3 Flute 130° High Performance Point • Coated and Uncoated

- Genuine A-Gr-SiV submicron grain carbide
- Proven, versatile performance
- MAP certified quality

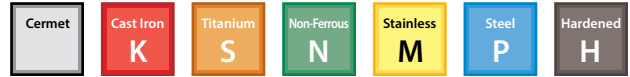
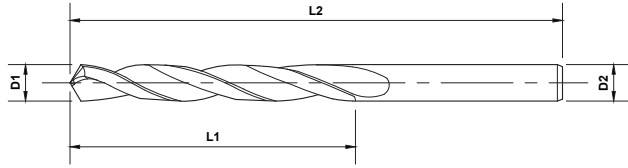

OD	LOC	SHK	OAL	Wire	Uncoated		PowerA	
					2 Flute	3 Flute	2 Flute	3 Flute
D1	L1	D2	L2	Letter				
.0670	3/4	.0670	1-1/2	51	601-050	-	601-050-1	-
.0700	7/8	.0700	1-3/4	50	601-052	-	601-052-1	-
.0730	7/8	.0730	1-3/4	49	601-054	-	601-054-1	-
.0760	7/8	.0760	1-3/4	48	601-056	-	601-056-1	-
5/64	7/8	5/64	1-3/4		601-058	-	601-058-1	-
.0785	7/8	.0785	1-3/4	47	601-060	-	601-060-1	-
.0787	7/8	.0787	1-3/4		601-062	-	601-062-1	-
.0810	7/8	.0810	1-3/4	46	601-064	-	601-064-1	-
.0820	7/8	.0820	1-3/4	45	601-066	-	601-066-1	-
.0860	1	.0860	2	44	601-068	-	601-068-1	-
.0890	1	.0890	2	43	601-070	-	601-070-1	-
.0935	1	.0935	2	42	601-072	-	601-072-1	-
3/32	1	3/32	2		601-074	-	601-074-1	-
.0960	1	.0960	2	41	601-076	-	601-076-1	-
.0980	1	.0980	2	40	601-078	-	601-078-1	-
.0984	1	.0984	2		601-080	-	601-080-1	-
.0995	1-1/4	.0995	2-1/4	39	601-082	-	601-082-1	-
.1015	1-1/4	.1015	2-1/4	38	601-084	-	601-084-1	-
.1040	1-1/4	.1040	2-1/4	37	601-086	-	601-086-1	-
.1065	1-1/4	.1065	2-1/4	36	601-088	-	601-088-1	-
7/64	1-1/4	7/64	2-1/4		601-090	-	601-090-1	-
.1100	1-1/4	.1100	2-1/4	35	601-092	-	601-092-1	-
.1110	1-1/4	.1110	2-1/4	34	601-094	-	601-094-1	-
.1130	1-1/4	.1130	2-1/4	33	601-096	-	601-096-1	-
.1160	1-1/4	.1160	2-1/4	32	601-098	-	601-098-1	-
.1181	1-1/4	.1181	2-1/4		601-100	-	601-100-1	-
.1200	1-1/4	.1200	2-1/4	31	601-102	-	601-102-1	-
1/8	1-1/4	1/8	2-1/4		601-104	601-504	601-104-1	601-504-1
.1285	1-3/8	.1285	2-1/2	30	601-106	601-506	601-106-1	601-506-1
.1360	1-3/8	.1360	2-1/2	29	601-108	601-508	601-108-1	601-508-1
.1378	1-3/8	.1378	2-1/2		601-110	601-510	601-110-1	601-510-1
.1405	1-3/8	.1405	2-1/2	28	601-112	601-512	601-112-1	601-512-1
9/64	1-3/8	9/64	2-1/2		601-114	601-514	601-114-1	601-514-1
.1440	1-3/8	.1440	2-1/2	27	601-116	601-516	601-116-1	601-516-1

Carbide Drills

JOBBER DRILLS

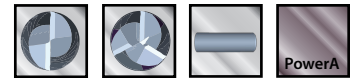

2 Flute 118° Four Facet Point • 3 Flute 130° High Performance Point • Coated and Uncoated

- Genuine A-Gr-SiV submicron grain carbide
- Proven, versatile performance
- MAP certified quality

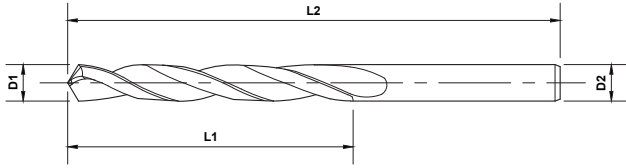

OD D1	LOC L1	SHK D2	OAL L2	Wire Letter	Uncoated		PowerA	
					2 Flute	3 Flute	2 Flute	3 Flute
.1470	1-3/8	.1470	2-1/2	26	601-118	601-518	601-118-1	601-518-1
.1495	1-3/8	.1495	2-1/2	25	601-120	601-520	601-120-1	601-520-1
.1520	1-3/8	.1520	2-1/2	24	601-122	601-522	601-122-1	601-522-1
.1540	1-3/8	.1540	2-1/2	23	601-124	601-524	601-124-1	601-524-1
5/32	1-3/8	5/32	2-1/2		601-126	601-526	601-126-1	601-526-1
.1570	1-3/8	.1570	2-1/2	22	601-128	601-528	601-128-1	601-528-1
.1575	1-3/8	.1575	2-1/2		601-130	601-530	601-130-1	601-530-1
.1590	1-3/8	.1590	2-1/2	21	601-132	601-532	601-132-1	601-532-1
.1610	1-3/8	.1610	2-1/2	20	601-134	601-534	601-134-1	601-534-1
.1660	1-5/8	.1660	2-3/4	19	601-136	601-536	601-136-1	601-536-1
.1695	1-5/8	.1695	2-3/4	18	601-138	601-538	601-138-1	601-538-1
11/64	1-5/8	11/64	2-3/4		601-140	601-540	601-140-1	601-540-1
.1730	1-5/8	.1730	2-3/4	17	601-142	601-542	601-142-1	601-542-1
.1770	1-5/8	.1770	2-3/4	16	601-144	601-544	601-144-1	601-544-1
.1772	1-5/8	.1772	2-3/4		601-146	601-546	601-146-1	601-546-1
.1800	1-5/8	.1800	2-3/4	15	601-148	601-548	601-148-1	601-548-1
.1820	1-5/8	.1820	2-3/4	14	601-150	601-550	601-150-1	601-550-1
.1850	1-5/8	.1850	2-3/4	13	601-152	601-552	601-152-1	601-552-1
3/16	1-5/8	3/16	2-3/4		601-154	601-554	601-154-1	601-554-1
.1890	1-5/8	.1890	2-3/4	12	601-156	601-556	601-156-1	601-556-1
.1910	1-5/8	.1910	2-3/4	11	601-158	601-558	601-158-1	601-558-1
.1935	1-5/8	.1935	2-3/4	10	601-160	601-560	601-160-1	601-560-1
.1960	1-3/4	.1960	3	9	601-162	601-562	601-162-1	601-562-1
.1968	1-3/4	.1968	3		601-164	601-564	601-164-1	601-564-1
.1990	1-3/4	.1990	3	8	601-166	601-566	601-166-1	601-566-1
.2010	1-3/4	.2010	3	7	601-168	601-568	601-168-1	601-568-1
13/64	1-3/4	13/64	3		601-170	601-570	601-170-1	601-570-1
.2040	1-3/4	.2040	3	6	601-172	601-572	601-172-1	601-572-1
.2055	1-3/4	.2055	3	5	601-174	601-574	601-174-1	601-574-1
.2090	1-3/4	.2090	3	4	601-176	601-576	601-176-1	601-576-1
.2130	1-3/4	.2130	3	3	601-178	601-578	601-178-1	601-578-1
.2165	1-3/4	.2165	3		601-180	601-580	601-180-1	601-580-1
7/32	1-3/4	7/32	3		601-182	601-582	601-182-1	601-582-1
.2210	1-3/4	.2210	3	2	601-184	601-584	601-184-1	601-584-1

JOBBER DRILLS

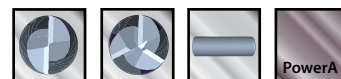

2 Flute 118° Four Facet Point • 3 Flute 130° High Performance Point • Coated and Uncoated

- Genuine A-Gr-SiV submicron grain carbide
- Proven, versatile performance
- MAP certified quality

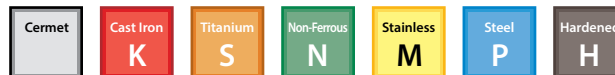
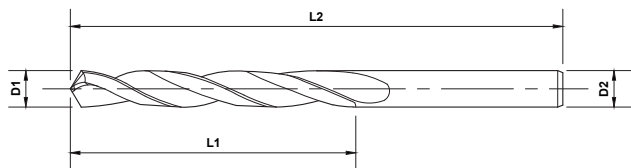

OD	LOC	SHK	OAL	Wire	Uncoated		PowerA	
D1	L1	D2	L2	Letter	2 Flute	3 Flute	2 Flute	3 Flute
.2280	1-3/4	.2280	3	I	601-186	601-586	601-186-1	601-586-1
.2340	2	.2340	3-1/4	A	601-188	601-588	601-188-1	601-588-1
15/64	2	15/64	3-1/4		601-190	601-590	601-190-1	601-590-1
.2362	2	.2362	3-1/4		601-192	601-592	601-192-1	601-592-1
.2380	2	.2380	3-1/4	B	601-194	601-594	601-194-1	601-594-1
.2420	2	.2420	3-1/4	C	601-196	601-596	601-196-1	601-596-1
.2460	2	.2460	3-1/4	D	601-198	601-598	601-198-1	601-598-1
1/4	2	1/4	3-1/4	E	601-200	601-600	601-200-1	601-600-1
.2559	2	.2559	3-1/4		601-202	601-602	601-202-1	601-602-1
.2570	2	.2570	3-1/4	F	601-204	601-604	601-204-1	601-604-1
.2610	2-1/8	.2610	3-1/2	G	601-206	601-606	601-206-1	601-606-1
17/64	2-1/8	17/64	3-1/2		601-208	601-608	601-208-1	601-608-1
.2660	2-1/8	.2660	3-1/2	H	601-210	601-610	601-210-1	601-610-1
.2720	2-1/8	.2720	3-1/2	I	601-212	601-612	601-212-1	601-612-1
.2756	2-1/8	.2756	3-1/2		601-214	601-614	601-214-1	601-614-1
.2770	2-1/8	.2770	3-1/2	J	601-216	601-616	601-216-1	601-616-1
.2810	2-1/8	.2810	3-1/2	K	601-218	601-618	601-218-1	601-618-1
9/32	2-1/8	9/32	3-1/2		601-220	601-620	601-220-1	601-620-1
.2900	2-1/8	.2900	3-1/2	L	601-222	601-622	601-222-1	601-622-1
.2950	2-3/8	.2950	4	M	601-224	601-624	601-224-1	601-624-1
.2953	2-3/8	.2953	4		601-226	601-626	601-226-1	601-626-1
19/64	2-3/8	19/64	4		601-228	601-628	601-228-1	601-628-1
.3020	2-3/8	.3020	4	N	601-230	601-630	601-230-1	601-630-1
5/16	2-3/8	5/16	4		601-232	601-632	601-232-1	601-632-1
.3150	2-3/8	.3150	4		601-234	601-634	601-234-1	601-634-1
.3160	2-3/8	.3160	4	O	601-236	601-636	601-236-1	601-636-1
.3230	2-3/8	.3230	4	P	601-238	601-638	601-238-1	601-638-1
21/64	2-3/8	21/64	4		601-240	601-640	601-240-1	601-640-1
.3320	2-3/8	.3320	4	Q	601-242	601-642	601-242-1	601-642-1
.3346	2-3/8	.3346	4		601-244	601-644	601-244-1	601-644-1
.3390	2-3/8	.3390	4	R	601-246	601-646	601-246-1	601-646-1
11/32	2-3/8	11/32	4		601-248	601-648	601-248-1	601-648-1
.3480	2-3/8	.3480	4	S	601-250	601-650	601-250-1	601-650-1
.3543	2-3/4	.3543	4-1/4		601-252	601-652	601-252-1	601-652-1

Carbide Drills

JOBBER DRILLS



2 Flute 118° Four Facet Point • 3 Flute 130° High Performance Point • Coated and Uncoated

- Genuine A-Gr-SiV submicron grain carbide
- Proven, versatile performance
- MAP certified quality

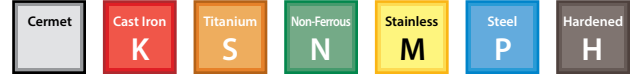
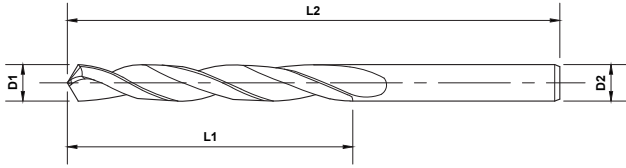

OD	LOC	SHK	OAL	Wire	Uncoated		PowerA	
D1	L1	D2	L2	Letter	2 Flute	3 Flute	2 Flute	3 Flute
.3580	2-3/4	.3580	4-1/4	T	601-254	601-654	601-254-1	601-654-1
23/64	2-3/4	23/64	4-1/4		601-256	601-656	601-256-1	601-656-1
.3680	2-3/4	.3680	4-1/4	U	601-258	601-658	601-258-1	601-658-1
.3740	2-3/4	.3740	4-1/4		601-260	601-660	601-260-1	601-660-1
3/8	2-3/4	3/8	4-1/4		601-262	601-662	601-262-1	601-662-1
.3770	2-3/4	.3770	4-1/4	V	601-264	601-664	601-264-1	601-664-1
.3860	2-7/8	.3860	4-1/2	W	601-266	601-666	601-266-1	601-666-1
25/64	2-7/8	25/64	4-1/2		601-268	601-668	601-268-1	601-668-1
.3937	2-7/8	.3937	4-1/2		601-270	601-670	601-270-1	601-670-1
.3970	2-7/8	.3970	4-1/2	X	601-272	601-672	601-272-1	601-672-1
.4040	2-7/8	.4040	4-1/2	Y	601-274	601-674	601-274-1	601-674-1
13/32	2-7/8	13/32	4-1/2		601-276	601-676	601-276-1	601-676-1
.4130	2-7/8	.4130	4-1/2	Z	601-278	601-678	601-278-1	601-678-1
.4134	2-7/8	.4134	4-1/2		601-280	601-680	601-280-1	601-680-1
27/64	2-7/8	27/64	4-1/2		601-282	601-682	601-282-1	601-682-1
.4331	2-7/8	.4331	4-1/2		601-284	601-684	601-284-1	601-684-1
7/16	2-7/8	7/16	4-1/2		601-286	601-686	601-286-1	601-686-1
.4527	3	.4527	4-3/4		601-288	601-688	601-288-1	601-688-1
29/64	3	29/64	4-3/4		601-290	601-690	601-290-1	601-690-1
15/32	3	15/32	4-3/4		601-292	601-692	601-292-1	601-692-1
.4724	3	.4724	4-3/4		601-294	601-694	601-294-1	601-694-1
31/64	3	31/64	4-3/4		601-296	601-696	601-296-1	601-696-1
.4921	3	.4921	4-3/4		601-298	601-698	601-298-1	601-698-1
1/2	3	1/2	4-3/4		601-300	601-700	601-300-1	601-700-1
17/32	4	17/32	6		601-302	601-702	601-302-1	601-702-1
9/16	4	9/16	6		601-304	601-704	601-304-1	601-704-1
19/32	4	19/32	6		601-306	601-706	601-306-1	601-706-1
5/8	4	5/8	6		601-308	601-708	601-308-1	601-708-1
21/32	4	21/32	6		601-310	601-710	601-310-1	601-710-1
11/16	4	11/16	6		601-312	601-712	601-312-1	601-712-1
23/32	4	23/32	6		601-314	601-714	601-314-1	601-714-1
3/4	4	3/4	6		601-316	601-716	601-316-1	601-716-1
25/32	4	25/32	6		601-318	-	601-318-1	-
7/8	4	7/8	6		601-320	601-720	601-320-1	601-720-1
1	4	1	6		601-322	601-722	601-322-1	601-722-1

STUB DRILLS

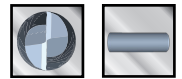

2 Flute • 135° & 118° Four Facet Point • Uncoated

- Genuine A-Gr-SiV submicron grain carbide
- Proven, versatile performance
- MAP certified quality

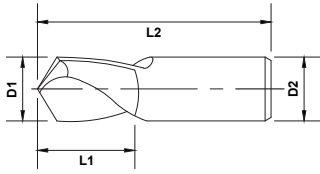

Stub, Series 603

Carbide Drills



OD	LOC	SHK	OAL	Wire	Point	Uncoated
D1	L1	D2	L2	Letter	Angle	2 Flute
.0465	1/2	.0465	1-1/2	#56	135°	603-002
3/64	1/2	3/64	1-1/2		135°	603-004
.0520	1/2	.0520	1-1/2	#55	135°	603-006
.0550	1/2	.0550	1-1/2	#54	135°	603-008
.0595	1/2	.0595	1-1/2	#53	135°	603-010
1/16	5/8	1/16	2		118°	603-012
.0635	5/8	.0635	2	#52	118°	603-014
.0670	5/8	.0670	2	#51	118°	603-016
.0700	5/8	.0700	2	#50	118°	603-018
.0730	5/8	.0730	2	#49	118°	603-020
.0760	5/8	.0760	2	#48	118°	603-022
5/64	5/8	5/64	2		118°	603-024
.0785	5/8	.0785	2	#47	118°	603-026
.0810	5/8	.0810	2	#46	118°	603-028
.0820	5/8	.0820	2	#45	118°	603-030
.0860	5/8	.0860	2	#44	118°	603-032
.0890	5/8	.0890	2	#43	118°	603-034
.0935	5/8	.0935	2	#42	118°	603-036

STUB DRILLS

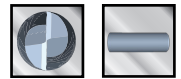

2 Flute • 135° & 118° Four Facet Point • Uncoated

- Genuine A-Gr-SiV submicron grain carbide
- Proven, versatile performance
- MAP certified quality

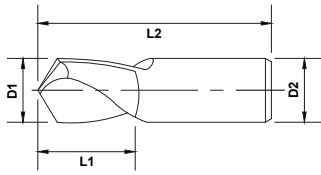

OD	LOC	SHK	OAL	Wire	Point	Uncoated
D1	L1	D2	L2	Letter	Angle	2 Flute
3/32	5/8	3/32	2		118°	603-038
.0960	5/8	.0960	2	#41	118°	603-040
.0980	5/8	.0980	2	#40	118°	603-042
.0995	5/8	.0995	2	#39	118°	603-044
.1015	5/8	.1015	2	#38	118°	603-046
.1040	5/8	.1040	2	#37	118°	603-048
.1065	5/8	.1065	2		118°	603-050
7/64	5/8	7/64	2		118°	603-052
.1100	5/8	.1100	2	#35	118°	603-054
.1110	5/8	.1110	2	#34	118°	603-056
.1130	5/8	.1130	2	#33	118°	603-058
.1160	5/8	.1160	2	#32	118°	603-060
.1200	5/8	.1200	2	#31	118°	603-062
1/8	5/8	1/8	2		118°	603-064
.1285	5/8	.1285	2	#30	118°	603-066
.1360	5/8	.1360	2		118°	603-068
.1405	5/8	.1405	2	#28	118°	603-070
9/64	5/8	9/64	2		118°	603-072
.1440	5/8	.1440	2	#27	118°	603-074
.1470	5/8	.1470	2	#26	118°	603-076
.1495	3/4	.1495	2-1/2		118°	603-078
.1520	3/4	.1520	2-1/2	#24	118°	603-080
.1540	3/4	.1540	2-1/2	#23	118°	603-082
5/32	3/4	5/32	2-1/2		118°	603-084
.1570	3/4	.1570	2-1/2		118°	603-086
.1590	3/4	.1590	2-1/2	#21	118°	603-088
.1610	3/4	.1610	2-1/2	#20	118°	603-090
.1660	3/4	.1660	2-1/2	#19	118°	603-092
.1695	3/4	.1695	2-1/2	#18	118°	603-094
11/64	3/4	11/64	2-1/2		118°	603-096
.1730	3/4	.1730	2-1/2	#17	118°	603-098
.1770	3/4	.1770	2-1/2	#16	118°	603-100
.1800	3/4	.1800	2-1/2	#15	118°	603-102

STUB DRILLS

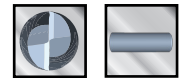

2 Flute • 135° & 118° Four Facet Point • Uncoated

- Genuine A-Gr-SiV submicron grain carbide
- Proven, versatile performance
- MAP certified quality

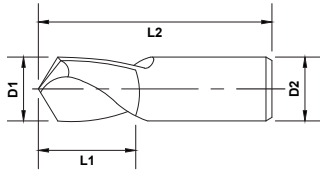

OD	LOC	SHK	OAL	Wire	Point	Uncoated
D1	L1	D2	L2	Letter	Angle	2 Flute
.1820	3/4	.1820	2-1/2	#14	118°	603-104
.1850	3/4	.1850	2-1/2	#13	118°	603-106
3/16	3/4	3/16	2-1/2		118°	603-108
.1890	3/4	.1890	2-1/2	#12	118°	603-110
.1910	3/4	.1910	2-1/2	#11	118°	603-112
.1935	3/4	.1935	2-1/2	#10	118°	603-114
.1960	3/4	.1960	2-1/2	#9	118°	603-116
.1990	3/4	.1990	2-1/2	#8	118°	603-118
.2010	3/4	.2010	2-1/2	#7	118°	603-120
13/64	3/4	13/64	2-1/2		118°	603-122
.2040	3/4	.2040	2-1/2	#6	118°	603-124
.2055	3/4	.2055	2-1/2	#5	118°	603-126
.2090	3/4	.2090	2-1/2	#4	118°	603-128
.2130	1	.2130	2-1/2		118°	603-130
7/32	1	7/32	2-1/2		118°	603-132
.2210	1	.2210	2-1/2	#2	118°	603-134
.2280	1	.2280	2-1/2	#1	118°	603-136
.2340	1	.2340	2-1/2	A	118°	603-138
15/64	1	15/64	2-1/2		118°	603-140
.2380	1	.2380	2-1/2	B	118°	603-142
.2420	1	.2420	2-1/2	C	118°	603-144
.2460	1	.2460	2-1/2	D	118°	603-146
1/4	1	1/4	2-1/2		118°	603-148
.2570	1	.2570	2-1/2		118°	603-150
.2610	1	.2610	2-1/2	G	118°	603-152
17/64	1	17/64	2-1/2		118°	603-154
.2660	1	.2660	2-1/2	H	118°	603-156
.2720	1	.2720	2-1/2	I	118°	603-158
.2786	1-1/4	.2756	2-1/2		118°	603-160
.2770	1	.2770	2-1/2	J	118°	603-162
.2810	1	.2810	2-1/2	K	118°	603-164
9/32	1	9/32	2-1/2		118°	603-166
.2900	1	.2900	2-1/2	L	118°	603-168

Carbide Drills

STUB DRILLS

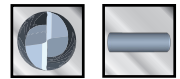

2 Flute • 135° & 118° Four Facet Point • Uncoated

- Genuine A-Gr-SiV submicron grain carbide
- Proven, versatile performance
- MAP certified quality

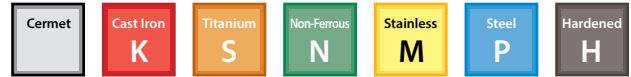
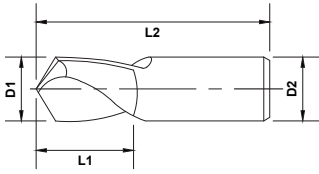

OD	LOC	SHK	OAL	Wire	Point	Uncoated
D1	L1	D2	L2	Letter	Angle	2 Flute
.2950	1	.2950	2-1/2	M	118°	603-170
19/64	1-1/4	19/64	2-3/4		118°	603-172
.3020	1-1/4	.3020	3	N	118°	603-174
5/16	1-1/4	5/16	2-3/4		118°	603-176
.3160	1-1/4	.3160	3	O	118°	603-178
.3230	1-1/4	.3230	3	P	118°	603-180
21/64	1-1/4	21/64	2-3/4		118°	603-182
.3320	1-1/4	.3320	3	Q	118°	603-184
.3390	1-1/4	.3390	3	R	118°	603-186
11/32	1-1/4	11/32	3		118°	603-188
.3480	1-1/4	.3480	3	S	118°	603-190
.3580	1-1/4	.3580	3	T	118°	603-192
23/64	1-1/4	23/64	3		118°	603-194
.3680	1-1/4	.3680	3	U	118°	603-196
3/8	1-1/4	3/8	3		118°	603-198
.3770	1-1/4	.3770	3	V	118°	603-200
.3860	1-1/4	.3860	3	W	118°	603-202
25/64	1-1/4	25/64	3		118°	603-204
.3970	1-1/4	.3970	3	X	118°	603-206
.4040	1-1/4	.4040	3	Y	118°	603-208
13/32	1-1/4	13/32	3		118°	603-210
.4130	1-1/4	.4130	3		118°	603-212
27/64	1-1/4	27/64	3		118°	603-214
7/16	1-1/4	7/16	3		118°	603-216
29/64	1-1/4	29/64	3		118°	603-218
15/32	1-1/4	15/32	3		118°	603-220
31/64	1-1/4	31/64	3		118°	603-222
1/2	1-1/4	1/2	3		118°	603-224
9/16	1-1/4	9/16	3-1/2		118°	603-226
5/8	1-1/2	5/8	3-1/2		118°	603-228
3/4	1-1/2	3/4	4		118°	603-230

STRAIGHT FLUTE DRILLS

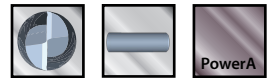

2 Flute • Coated and Uncoated • Point Angle 135°

- Genuine A-Gr-SiV submicron grain carbide
- Superb performance in hardened materials
- MAP certified quality

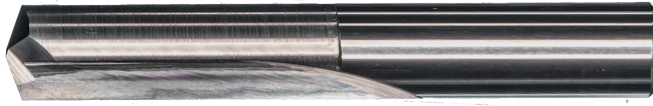
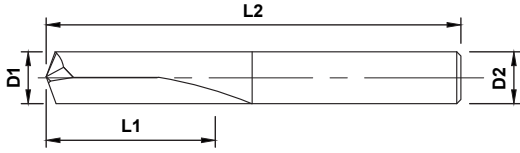

Standard, Series 604



OD	LOC	SHK	OAL	Uncoated	PowerA
D1	L1	D2	L2	2 Flute	2 Flute
3/32	1/2	3/32	1-1/2	604-002	604-002-1
1/8	5/8	1/8	1-1/2	604-004	604-004-1
9/64	5/8	9/64	2	604-006	604-006-1
5/32	5/8	5/32	2	604-008	604-008-1
11/64	5/8	11/64	2	604-010	604-010-1
3/16	5/8	3/16	2	604-012	604-012-1
13/64	3/4	13/64	2	604-014	604-014-1
7/32	3/4	7/32	2	604-016	604-016-1
15/64	3/4	15/64	2	604-018	604-018-1
1/4	3/4	1/4	2	604-020	604-020-1
17/64	3/4	17/64	2-1/2	604-022	604-022-1
9/32	3/4	9/32	2-1/2	604-024	604-024-1
19/64	3/4	19/64	2-1/2	604-026	604-026-1
5/16	3/4	5/16	2-1/2	604-028	604-028-1
21/64	1	21/64	2-1/2	604-030	604-030-1
11/32	1	11/32	2-1/2	604-032	604-032-1
23/64	1	23/64	2-1/2	604-034	604-034-1
3/8	1	3/8	2-1/2	604-036	604-036-1
25/64	1	25/64	2-3/4	604-038	604-038-1
13/32	1	13/32	2-3/4	604-040	604-040-1
27/64	1	27/64	2-3/4	604-042	604-042-1
7/16	1	7/16	2-3/4	604-044	604-044-1
29/64	1	29/64	3	604-046	604-046-1
15/32	1	15/32	3	604-048	604-048-1
31/64	1	31/64	3	604-050	604-050-1
1/2	1	1/2	3	604-052	604-052-1

SPADE DRILLS

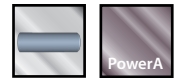

118° Point • Coated and Uncoated

- Genuine A-Gr-SiV submicron grain carbide
- Proven versatile performance
- MAP certified quality

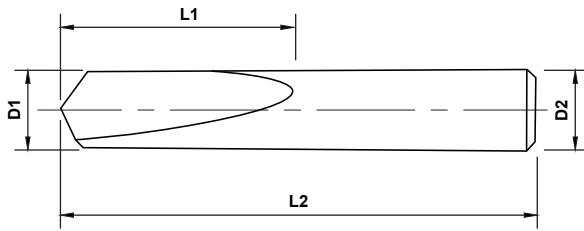

Standard, Series 600



OD	LOC	SHK	OAL	Uncoated	PowerA
D1	L1	D2	L2		
1/16	5/16	1/16	1-1/2	600-004	600-004-1
3/32	3/8	3/32	1-1/2	600-006	600-006-1
1/8	7/16	1/8	1-1/2	600-008	600-008-1
5/32	15/32	5/32	2	600-010	600-010-1
3/16	9/16	3/16	2	600-012	600-012-1
7/32	19/32	7/32	2	600-014	600-014-1
1/4	11/16	1/4	2	600-016	600-016-1
9/32	3/4	9/32	2-1/2	600-018	600-018-1
5/16	7/8	5/16	2-1/2	600-020	600-020-1
3/8	1	3/8	2-1/2	600-022	600-022-1
7/16	1-1/4	7/16	2-1/2	600-024	600-024-1
1/2	1-3/8	1/2	2-1/2	600-026	600-026-1

NC SPOTTING DRILLS

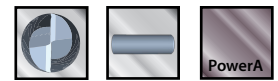

90°, 120° and 142° • Coated and Uncoated

- Genuine A-Gr-SiV submicron grain carbide
- Proven versatile performance
- MAP certified quality

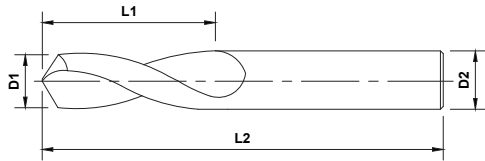

Standard, Series 600



OD	LOC	SHK	OAL	Uncoated			PowerA		
				D1	L1	D2	L2	90°	120°
1/8	3/8	1/8	2	600-402	600-502	600-602	600-402-1	600-502-1	600-602-1
3/16	3/4	3/16	3	600-404	600-504	600-604	600-404-1	600-504-1	600-604-1
1/4	3/4	1/4	3	600-406	600-506	600-606	600-406-1	600-506-1	600-606-1
5/16	1	5/16	2-1/2	600-408	600-508	600-608	600-408-1	600-508-1	600-608-1
3/8	1	3/8	3	600-410	600-510	600-610	600-410-1	600-510-1	600-610-1
1/2	1	1/2	4	600-412	600-512	600-612	600-412-1	600-512-1	600-612-1

DRILL AND COUNTERSINK

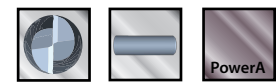

118° point Center Drills • 60°, 82° and 90° Countersink • Coated and Uncoated

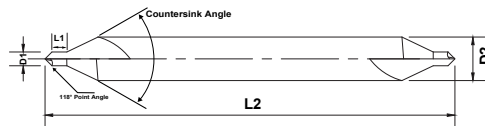

Standard, Series 600

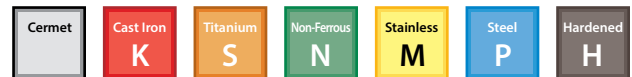

#	OD	LOC	SHK	OAL	Uncoated			PowerA		
					D1	L1	D2	L2	60°	82°
1	3/64	3/64	1/8	1-1/2	600-304	600-104	600-204	600-304-1	600-104-1	600-204-1
2	5/64	5/64	3/16	2	600-306	600-106	600-206	600-306-1	600-106-1	600-206-1
3	7/64	7/64	1/4	2	600-308	600-108	600-208	600-308-1	600-108-1	600-208-1
4	1/8	1/8	5/16	2-1/8	600-310	600-110	600-210	600-310-1	600-110-1	600-210-1
5	3/16	3/16	7/16	2-3/4	600-312	600-112	600-212	600-312-1	600-112-1	600-212-1
6	7/32	7/32	1/2	3	600-314	600-114	600-214	600-314-1	600-114-1	600-214-1
7	1/4	1/4	5/8	3-1/8	600-316	600-116	600-216	600-316-1	600-116-1	600-216-1
8	5/16	5/16	3/4	3-3/8	600-318	600-118	600-218	600-318-1	600-118-1	600-218-1

SINGLE FLUTE COUNTERSINKS

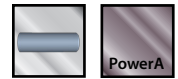

Single Flute • 60°, 82° and 90° • Coated and Uncoated

- Genuine A-Gr-SiV submicron grain carbide
- Proven, versatile performance

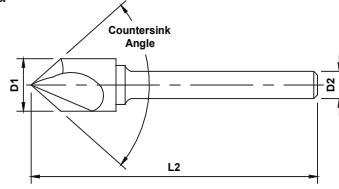

Standard, Series 680

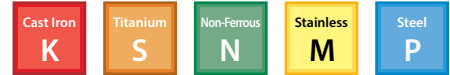

OD	SHK	OAL	Uncoated			PowerA		
			60°	82°	90°	60°	82°	90°
D1	D2	L2						
1/8	1/8	1-1/2	680-002	680-102	680-202	680-002-1	680-102-1	680-202-1
3/16	3/16	2	680-004	680-104	680-204	680-004-1	680-104-1	680-204-1
1/4	1/4	2	680-006	680-106	680-206	680-006-1	680-106-1	680-206-1
3/8	1/4	2-1/2	680-008	680-108	680-208	680-008-1	680-108-1	680-208-1
1/2	1/4	2-3/4	680-010	680-110	680-210	680-010-1	680-110-1	680-210-1
5/8	3/8	3	680-012	680-112	680-212	680-012-1	680-112-1	680-212-1
3/4	1/2	3	680-014	680-114	680-214	680-014-1	680-114-1	680-214-1
1	1/2	3	680-016	680-116	680-216	680-016-1	680-116-1	680-216-1

THREE FLUTE COUNTERSINKS

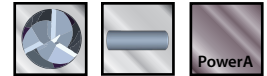

Three Flute • 60°, 82°, 90° and 100° • Coated and Uncoated

- Genuine A-Gr-SiV submicron grain carbide
- Proven, versatile performance

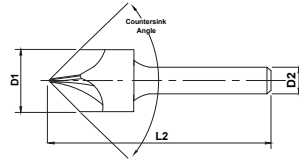

Standard, Series 680



OD	SHK	OAL	Uncoated				PowerA			
			60°	82°	90°	100°	60°	82°	90°	100°
D1	D2	L2								
1/8	1/8	1-1/2	680-302	680-402	680-502	-	680-302-1	680-402-1	680-502-1	-
3/16	3/16	2	680-304	680-404	680-504	-	680-304-1	680-404-1	680-504-1	-
1/4	1/4	2	680-306	680-406	680-506	682-106	680-306-1	680-406-1	680-506-1	682-106-1
3/8	1/4	2-1/2	680-308	680-408	680-508	682-108	680-308-1	680-408-1	680-508-1	682-108-1
1/2	1/4	2-3/4	680-310	680-410	680-510	682-110	680-310-1	680-410-1	680-510-1	682-110-1
5/8	3/8	3	680-312	680-412	680-512	682-112	680-312-1	680-412-1	680-512-1	682-112-1
3/4	1/2	3	680-314	680-414	680-514	682-114	680-314-1	680-414-1	680-514-1	682-114-1
1	1/2	3	680-316	680-416	680-516	682-116	680-316-1	680-416-1	680-516-1	682-116-1

SIX FLUTE COUNTERSINKS

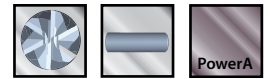

Six Flute • 60°, 82°, 90°, and 100° • Coated and Uncoated

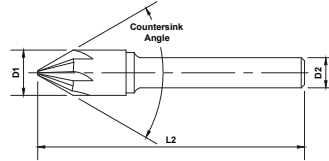

- Genuine A-Gr-SiV submicron grain carbide
- Proven, versatile performance



Standard, Series 680



OD	SHK	OAL	Uncoated				PowerA					
			D1	D2	L2	60°	82°	90°	100°	60°	82°	90°
1/8	1/8	1-1/2	680-602	680-702	680-802	-	680-602-1	680-702-1	680-802-1	-		
3/16	3/16	2	680-604	680-704	680-804	-	680-604-1	680-704-1	680-804-1	-		
1/4	1/4	2	680-606	680-706	680-806	680-906	680-606-1	680-706-1	680-806-1	680-906-1		
3/8	1/4	2-1/2	680-608	680-708	680-808	680-908	680-608-1	680-708-1	680-808-1	680-908-1		
1/2	1/4	2-3/4	680-610	680-710	680-810	680-910	680-610-1	680-710-1	680-810-1	680-910-1		
5/8	3/8	3	680-612	680-712	680-812	680-912	680-612-1	680-712-1	680-812-1	680-912-1		
3/4	1/2	3	680-614	680-714	680-814	680-914	680-614-1	680-714-1	680-814-1	680-914-1		
1	1/2	3	680-616	680-716	680-816	680-916	680-616-1	680-716-1	680-816-1	680-916-1		

CHAMFER TOOLS

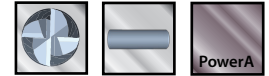

Four Flute • 60°, 82° and 90° • Coated and Uncoated

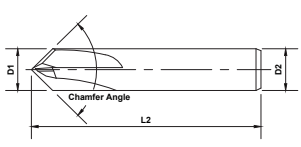

- Genuine A-Gr-SiV submicron grain carbide
- Proven, versatile performance



Standard, Series 681



OD	SHK	OAL	Uncoated			PowerA		
			D1	D2	L2	60°	82°	90°
1/8	1/8	2	681-002	681-102	681-202	681-002-1	681-102-1	681-202-1
3/16	3/16	2	681-004	681-104	681-204	681-004-1	681-104-1	681-204-1
1/4	1/4	2-1/2	681-006	681-106	681-206	681-006-1	681-106-1	681-206-1
5/16	5/16	2-1/2	681-008	681-108	681-208	681-008-1	681-108-1	681-208-1
3/8	3/8	2-1/2	681-010	681-110	681-210	681-010-1	681-110-1	681-210-1
1/2	1/2	3	681-012	681-112	681-212	681-012-1	681-112-1	681-212-1

HIGH PERFORMANCE DRILLS

Hurricane Drill Series

- **Non-Coolant Through**
- **Coolant Through**



Our continuous improvement has led us to a process that gives you unmatched, consistent quality. That process is our unique MAP Technology! Mastercut Automated Production is our exclusive method of standardization and quality repeatability. The MAP combines technology, skill, and rigid processes to provide you with the most precise products that money can buy, batch to batch and year to year.

Our MAP...your map to success!

TABLE OF CONTENTS



 Hurricane 3XD Non-Coolant & Coolant Through 142

 Hurricane 5XD Non-Coolant & Coolant Through 146

 Hurricane 8XD Coolant Through 152



Features Legend

	2 FL Non-Coolant Through		Plain shank
	2 FL Coolant Through		

Coatings Legend

	PowerA Coating
--	-------------------

Mastercut's Superior Carbide Blend – A-Gr-SiV (Active Grain Sized Volume)

Our superior tungsten carbide gives you the ability to be *aggressive* when you need to be. Growth inhibitors in our sub-micron carbide blanks maintain the most consistent grain size available, giving you superior hardness AND toughness.

HURRICANE HIGH PERFORMANCE DRILL FEATURES



- High performance drill with a common shank
- Coolant Through and Non-Coolant Through styles available
- 3xD, 5xD, 8xD
- Uncoated and PowerA coating available
- Now also available in PowerNR coating (call for information)



Please contact us for our full line of metric products.

HURRICANE DRILLS - 3xD

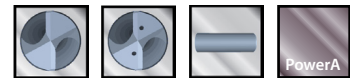

HIGH PERFORMANCE DRILLS

3xD • 2 FL, 140° Point and 30° Helix • Coated and Uncoated

- High Performance A-Gr-SiV submicron grain carbide
- Coolant and non-coolant through
- Rigid design for fast feed rates
- MAP certified quality

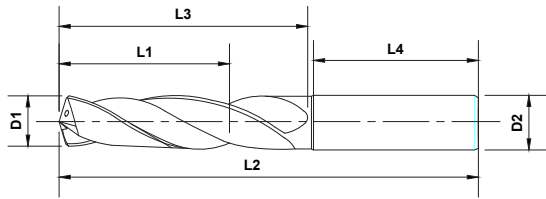

Series 650



Series 650, PowerA



OD	LOC	LOF	SHK	SHK-L	OAL	Uncoated		PowerA	
						Non-Coolant Through	Coolant Through	Non-Coolant Through	Coolant Through
D1	L1	L3	D2	L4	L2				
.1181	0.5511	0.787	0.2362	1.417	2.44	750-002	-	750-002-1	-
.1220	0.5511	0.787	0.2362	1.417	2.44	750-004	-	750-004-1	-
.1248	0.5511	0.787	0.2362	1.417	2.44	750-006	-	750-006-1	-
1/8	0.5511	0.787	0.2362	1.417	2.44	750-008	-	750-008-1	-
.1260	0.5511	0.787	0.2362	1.417	2.44	750-010	-	750-010-1	-
.1280	0.5511	0.787	0.2362	1.417	2.44	750-012	-	750-012-1	-
.1299	0.5511	0.787	0.2362	1.417	2.44	750-014	-	750-014-1	-
.1339	0.5511	0.787	0.2362	1.417	2.44	750-016	750-516	750-016-1	750-516-1
.1378	0.5511	0.787	0.2362	1.417	2.44	750-018	750-518	750-018-1	750-518-1
9/64	0.5511	0.787	0.2362	1.417	2.44	750-022	750-522	750-022-1	750-522-1
.1417	0.5511	0.787	0.2362	1.417	2.44	750-024	750-524	750-024-1	750-524-1
.1457	0.5511	0.787	0.2362	1.417	2.44	750-026	750-526	750-026-1	750-526-1
.1496	0.6690	0.944	0.2362	1.417	2.59	750-028	750-528	750-028-1	750-528-1
.1535	0.6690	0.944	0.2362	1.417	2.59	750-030	750-530	750-030-1	750-530-1
5/32	0.6690	0.944	0.2362	1.417	2.59	750-032	750-532	750-032-1	750-532-1
.1575	0.6690	0.944	0.2362	1.417	2.59	750-036	750-536	750-036-1	750-536-1
.1614	0.6690	0.944	0.2362	1.417	2.59	750-038	750-538	750-038-1	750-538-1
.1654	0.6690	0.944	0.2362	1.417	2.59	750-040	750-540	750-040-1	750-540-1
.1693	0.6690	0.944	0.2362	1.417	2.59	750-042	750-542	750-042-1	750-542-1
11/64	0.6690	0.944	0.2362	1.417	2.59	750-044	750-544	750-044-1	750-544-1
.1720	0.6690	0.944	0.2362	1.417	2.59	750-046	750-546	750-046-1	750-546-1
.1732	0.6690	0.944	0.2362	1.417	2.59	750-048	750-548	750-048-1	750-548-1
.1772	0.6690	0.944	0.2362	1.417	2.59	750-050	750-550	750-050-1	750-550-1
.1811	0.6690	0.944	0.2362	1.417	2.59	750-052	750-552	750-052-1	750-552-1
.1831	0.6690	0.944	0.2362	1.417	2.59	750-054	750-554	750-054-1	750-554-1
.1850	0.6690	0.944	0.2362	1.417	2.59	750-056	750-556	750-056-1	750-556-1

* For extreme performance drilling, try our PowerNR coating. Use the uncoated part number and add -8.

HURRICANE DRILLS - 3xD

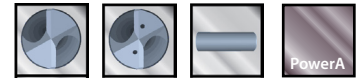

HIGH PERFORMANCE DRILLS

3xD • 2 FL, 140° Point and 30° Helix • Coated and Uncoated

- High Performance A-Gr-SiV submicron grain carbide
- Coolant and non-coolant through
- Rigid design for fast feed rates
- MAP certified quality

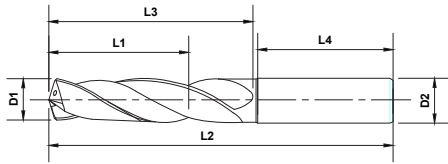

OD	LOC	LOF	SHK	SHK-L	OAL	Uncoated		PowerA	
D1	L1	L3	D2	L4	L2	Non-Coolant Through	Coolant Through	Non-Coolant Through	Coolant Through
.1874	0.7874	1.102	0.2362	1.417	2.59	750-058	750-558	750-058-1	750-558-1
3/16	0.7874	1.102	0.2362	1.417	2.59	750-060	750-560	750-060-1	750-560-1
.1890	0.7874	1.102	0.2362	1.417	2.59	750-062	750-562	750-062-1	750-562-1
.1929	0.7874	1.102	0.2362	1.417	2.59	750-064	750-564	750-064-1	750-564-1
.1969	0.7874	1.102	0.2362	1.417	2.59	750-066	750-566	750-066-1	750-566-1
.2008	0.7874	1.102	0.2362	1.417	2.59	750-068	750-568	750-068-1	750-568-1
13/64	0.7874	1.102	0.2362	1.417	2.59	750-070	750-570	750-070-1	750-570-1
.2047	0.7874	1.102	0.2362	1.417	2.59	750-074	750-574	750-074-1	750-574-1
.2087	0.7874	1.102	0.2362	1.417	2.59	750-076	750-576	750-076-1	750-576-1
.2126	0.7874	1.102	0.2362	1.417	2.59	750-078	750-578	750-078-1	750-578-1
.2165	0.7874	1.102	0.2362	1.417	2.59	750-080	750-580	750-080-1	750-580-1
.2185	0.7874	1.102	0.2362	1.417	2.59	750-082	750-582	750-082-1	750-582-1
7/32	0.7874	1.102	0.2362	1.417	2.59	750-084	750-584	750-084-1	750-584-1
.2189	0.7874	1.102	0.2362	1.417	2.59	750-086	750-586	750-086-1	750-586-1
.2205	0.7874	1.102	0.2362	1.417	2.59	750-088	750-588	750-088-1	750-588-1
.2244	0.7874	1.102	0.2362	1.417	2.59	750-090	750-590	750-090-1	750-590-1
.2283	0.7874	1.102	0.2362	1.417	2.59	750-092	750-592	750-092-1	750-592-1
.2323	0.7874	1.102	0.2362	1.417	2.59	750-094	750-594	750-094-1	750-594-1
.2343	0.7874	1.102	0.2362	1.417	2.59	750-096	750-596	750-096-1	750-596-1
15/64	0.7874	1.102	0.2362	1.417	2.59	750-098	750-598	750-098-1	750-598-1
.2362	0.7874	1.102	0.2362	1.417	2.59	750-100	750-600	750-100-1	750-600-1
.2402	0.9448	1.338	0.3150	1.417	3.11	750-102	750-602	750-102-1	750-602-1
.2441	0.9448	1.338	0.3150	1.417	3.11	750-104	750-604	750-104-1	750-604-1
.2480	0.9448	1.338	0.3150	1.417	3.11	750-106	750-606	750-106-1	750-606-1
1/4	0.9448	1.338	0.3150	1.417	3.11	750-108	750-608	750-108-1	750-608-1
.2520	0.9448	1.338	0.3150	1.417	3.11	750-110	750-610	750-110-1	750-610-1
.2559	0.9448	1.338	0.3150	1.417	3.11	750-112	750-612	750-112-1	750-612-1
.2598	0.9448	1.338	0.3150	1.417	3.11	750-114	750-614	750-114-1	750-614-1
.2638	0.9448	1.338	0.3150	1.417	3.11	750-116	750-616	750-116-1	750-616-1
17/64	0.9448	1.338	0.3150	1.417	3.11	750-118	750-618	750-118-1	750-618-1
.2657	0.9448	1.338	0.3150	1.417	3.11	750-120	750-620	750-120-1	750-620-1
.2677	0.9448	1.338	0.3150	1.417	3.11	750-122	750-622	750-122-1	750-622-1
.2717	0.9448	1.338	0.3150	1.417	3.11	750-124	750-624	750-124-1	750-624-1
.2756	0.9448	1.338	0.3150	1.417	3.11	750-126	750-626	750-126-1	750-626-1
.2795	1.1410	1.614	0.3150	1.417	3.11	750-128	750-628	750-128-1	750-628-1
.2811	1.1410	1.614	0.3150	1.417	3.11	750-130	750-630	750-130-1	750-630-1
9/32	1.1410	1.614	0.3150	1.417	3.11	750-132	750-632	750-132-1	750-632-1
.2835	1.1410	1.614	0.3150	1.417	3.11	750-134	750-634	750-134-1	750-634-1
.2874	1.1410	1.614	0.3150	1.417	3.11	750-136	750-636	750-136-1	750-636-1
.2913	1.1410	1.614	0.3150	1.417	3.11	750-138	750-638	750-138-1	750-638-1
.2953	1.1410	1.614	0.3150	1.417	3.11	750-140	750-640	750-140-1	750-640-1

* For extreme performance drilling, try our PowerNR coating. Use the uncoated part number and add -8.

High Performance Drills



HURRICANE DRILLS - 3xD

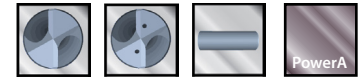

HIGH PERFORMANCE DRILLS

3xD • 2 FL, 140° Point and 30° Helix • Coated and Uncoated

- High Performance A-Gr-SiV submicron grain carbide
- Coolant and non-coolant through
- Rigid design for fast feed rates
- MAP certified quality

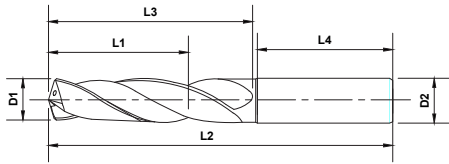

OD	LOC	LOF	SHK	SHK-L	OAL	Uncoated		PowerA	
						Non-Coolant Through	Coolant Through	Non-Coolant Through	Coolant Through
D1	L1	L3	D2	L4	L2				
19/64	1.1410	1.614	0.3150	1.417	3.11	750-144	750-644	750-144-1	750-644-1
.2992	1.1410	1.614	0.3150	1.417	3.11	750-146	750-646	750-146-1	750-646-1
.3031	1.1410	1.614	0.3150	1.417	3.11	750-148	750-648	750-148-1	750-648-1
.3071	1.1410	1.614	0.3150	1.417	3.11	750-150	750-650	750-150-1	750-650-1
.3110	1.1410	1.614	0.3150	1.417	3.11	750-152	750-652	750-152-1	750-652-1
5/16	1.1410	1.614	0.3150	1.417	3.11	750-154	750-654	750-154-1	750-654-1
.3126	1.1410	1.614	0.3150	1.417	3.11	750-156	750-656	750-156-1	750-656-1
.3150	1.1410	1.614	0.3150	1.417	3.11	750-158	750-658	750-158-1	750-658-1
.3189	1.3770	1.850	0.3937	1.575	3.50	750-160	750-660	750-160-1	750-660-1
.3228	1.3770	1.850	0.3937	1.575	3.50	750-162	750-662	750-162-1	750-662-1
.3268	1.3770	1.850	0.3937	1.575	3.50	750-164	750-664	750-164-1	750-664-1
.3280	1.3770	1.850	0.3937	1.575	3.50	750-166	750-666	750-166-1	750-666-1
21/64	1.3770	1.850	0.3937	1.575	3.50	750-168	750-668	750-168-1	750-668-1
.3307	1.3770	1.850	0.3937	1.575	3.50	750-170	750-670	750-170-1	750-670-1
.3346	1.3770	1.850	0.3937	1.575	3.50	750-172	750-672	750-172-1	750-672-1
.3386	1.3770	1.850	0.3937	1.575	3.50	750-174	750-674	750-174-1	750-674-1
.3425	1.3770	1.850	0.3937	1.575	3.50	750-176	750-676	750-176-1	750-676-1
11/32	1.3770	1.850	0.3937	1.575	3.50	750-180	750-680	750-180-1	750-680-1
.3465	1.3770	1.850	0.3937	1.575	3.50	750-182	750-682	750-182-1	750-682-1
.3504	1.3770	1.850	0.3937	1.575	3.50	750-184	750-684	750-184-1	750-684-1
.3543	1.3770	1.850	0.3937	1.575	3.50	750-186	750-686	750-186-1	750-686-1
.3583	1.3770	1.850	0.3937	1.575	3.50	750-188	750-688	750-188-1	750-688-1
23/64	1.3770	1.850	0.3937	1.575	3.50	750-190	750-690	750-190-1	750-690-1
.3622	1.3770	1.850	0.3937	1.575	3.50	750-194	750-694	750-194-1	750-694-1
.3642	1.3770	1.850	0.3937	1.575	3.50	750-196	750-696	750-196-1	750-696-1
.3661	1.3770	1.850	0.3937	1.575	3.50	750-198	750-698	750-198-1	750-698-1
.3701	1.3770	1.850	0.3937	1.575	3.50	750-200	750-700	750-200-1	750-700-1
.3740	1.3770	1.850	0.3937	1.575	3.50	750-202	750-702	750-202-1	750-702-1
.3748	1.3770	1.850	0.3937	1.575	3.50	750-204	750-704	750-204-1	750-704-1
3/8	1.3770	1.850	0.3937	1.575	3.50	750-206	750-706	750-206-1	750-706-1
.3780	1.3770	1.850	0.3937	1.575	3.50	750-208	750-708	750-208-1	750-708-1
.3819	1.3770	1.850	0.3937	1.575	3.50	750-210	750-710	750-210-1	750-710-1
.3858	1.3770	1.850	0.3937	1.575	3.50	750-212	750-712	750-212-1	750-712-1
.3898	1.3770	1.850	0.3937	1.575	3.50	750-214	750-714	750-214-1	750-714-1
25/64	1.3770	1.850	0.3937	1.575	3.50	750-218	750-718	750-218-1	750-718-1
.3937	1.3770	1.850	0.3937	1.575	3.50	750-220	750-720	750-220-1	750-720-1
.3976	1.5740	2.165	0.4724	1.772	4.01	750-222	750-722	750-222-1	750-722-1
.4016	1.5740	2.165	0.4724	1.772	4.01	750-224	750-724	750-224-1	750-724-1
.4055	1.5740	2.165	0.4724	1.772	4.01	750-226	750-726	750-226-1	750-726-1
13/32	1.5740	2.165	0.4724	1.772	4.01	750-228	750-728	750-228-1	750-728-1
.4094	1.5740	2.165	0.4724	1.772	4.01	750-232	750-732	750-232-1	750-732-1
.4134	1.5740	2.165	0.4724	1.772	4.01	750-234	750-734	750-234-1	750-734-1
.4173	1.5740	2.165	0.4724	1.772	4.01	750-236	750-736	750-236-1	750-736-1

* For extreme performance drilling, try our PowerNR coating. Use the uncoated part number and add -8.

HURRICANE DRILLS - 3xD

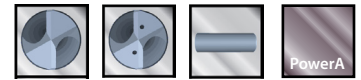

HIGH PERFORMANCE DRILLS

3xD • 2 FL, 140° Point and 30° Helix • Coated and Uncoated

- High Performance A-Gr-SiV submicron grain carbide
- Coolant and non-coolant through
- Rigid design for fast feed rates
- MAP certified quality

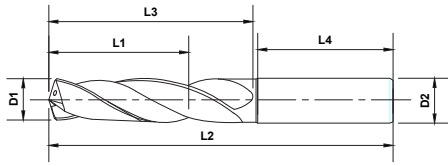

OD	LOC	LOF	SHK	SHK-L	OAL	Uncoated		PowerA	
D1	L1	L3	D2	L4	L2	Non-Coolant Through	Coolant Through	Non-Coolant Through	Coolant Through
.4213	1.5740	2.165	0.4724	1.772	4.01	750-238	750-738	750-238-1	750-738-1
.27/64	1.5740	2.165	0.4724	1.772	4.01	750-240	750-740	750-240-1	750-740-1
.4252	1.5740	2.165	0.4724	1.772	4.01	750-242	750-742	750-242-1	750-742-1
.4291	1.5740	2.165	0.4724	1.772	4.01	750-244	750-744	750-244-1	750-744-1
.4331	1.5740	2.165	0.4724	1.772	4.01	750-246	750-746	750-246-1	750-746-1
.4370	1.5740	2.165	0.4724	1.772	4.01	750-248	750-748	750-248-1	750-748-1
.4374	1.5740	2.165	0.4724	1.772	4.01	750-250	750-750	750-250-1	750-750-1
7/16	1.5740	2.165	0.4724	1.772	4.01	750-252	750-752	750-252-1	750-752-1
.4409	1.5740	2.165	0.4724	1.772	4.01	750-254	750-754	750-254-1	750-754-1
.4449	1.5740	2.165	0.4724	1.772	4.01	750-256	750-756	750-256-1	750-756-1
.4488	1.5740	2.165	0.4724	1.772	4.01	750-258	750-758	750-258-1	750-758-1
.4528	1.5740	2.165	0.4724	1.772	4.01	750-260	750-760	750-260-1	750-760-1
.29/64	1.5740	2.165	0.4724	1.772	4.01	750-262	750-762	750-262-1	750-762-1
.4567	1.5740	2.165	0.4724	1.772	4.01	750-264	750-764	750-264-1	750-764-1
.4606	1.5740	2.165	0.4724	1.772	4.01	750-266	750-766	750-266-1	750-766-1
.4646	1.5740	2.165	0.4724	1.772	4.01	750-268	750-768	750-268-1	750-768-1
.4685	1.5740	2.165	0.4724	1.772	4.01	750-270	750-770	750-270-1	750-770-1
15/32	1.5740	2.165	0.4724	1.772	4.01	750-272	750-772	750-272-1	750-772-1
.4689	1.5740	2.165	0.4724	1.772	4.01	750-274	750-774	750-274-1	750-774-1
.4724	1.5740	2.165	0.4724	1.772	4.01	750-276	750-776	750-276-1	750-776-1
31/64	1.5740	2.165	0.5512	1.772	4.01	750-278	750-778	750-278-1	750-778-1
.4921	1.6920	2.362	0.5512	1.772	4.21	750-280	750-780	750-280-1	750-780-1
1/2	1.6920	2.362	0.5512	1.772	4.21	750-284	750-784	750-284-1	750-784-1
.5118	1.6920	2.362	0.5512	1.772	4.21	750-286	750-786	750-286-1	750-786-1
.5315	1.6920	2.362	0.5512	1.772	4.21	750-288	750-788	750-288-1	750-788-1
.5394	1.6920	2.362	0.5512	1.772	4.21	750-290	750-790	750-290-1	750-790-1
.5512	1.6920	2.362	0.5512	1.772	4.21	750-292	750-792	750-292-1	750-792-1
9/16	1.7710	2.559	0.6299	1.889	4.52	750-294	750-794	750-294-1	750-794-1
.5709	1.7710	2.559	0.6299	1.889	4.52	750-296	750-796	750-296-1	750-796-1
.5787	1.7710	2.559	0.6299	1.889	4.52	750-298	750-798	750-298-1	750-798-1
.5906	1.7710	2.559	0.6299	1.889	4.52	750-300	750-800	750-300-1	750-800-1
.6102	1.7710	2.559	0.6299	1.889	4.52	750-302	750-802	750-302-1	750-802-1
.6181	1.7710	2.559	0.6299	1.889	4.52	750-304	750-804	750-304-1	750-804-1
.6299	1.7710	2.559	0.6299	1.889	4.52	750-306	750-806	750-306-1	750-806-1
.6496	2.007	2.874	0.7087	1.889	4.84	750-308	750-808	750-308-1	750-808-1
.6693	2.007	2.874	0.7087	1.889	4.84	750-310	750-810	750-310-1	750-810-1
.6890	2.007	2.874	0.7087	1.889	4.84	750-312	750-812	750-312-1	750-812-1
.7087	2.007	2.874	0.7087	1.889	4.84	750-314	750-814	750-314-1	750-814-1
.7283	2.165	3.110	0.7874	1.969	5.15	750-316	750-816	750-316-1	750-816-1
.7480	2.165	3.110	0.7874	1.969	5.15	750-318	750-818	750-318-1	750-818-1
.7677	2.165	3.110	0.7874	1.969	5.15	750-320	750-820	750-320-1	750-820-1
.7874	2.165	3.110	0.7874	1.969	5.15	750-322	750-822	750-322-1	750-822-1

* For extreme performance drilling, try our PowerNR coating. Use the uncoated part number and add -8.

High Performance Drills

HURRICANE DRILLS - 5xD

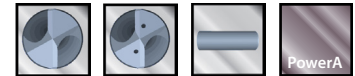

HIGH PERFORMANCE DRILLS

5xD • 2 FL, 140° Point and 30° Helix • Coated and Uncoated

- High Performance A-Gr-SiV submicron grain carbide
- Coolant and non-coolant through
- Rigid design for fast feed rates
- MAP certified quality

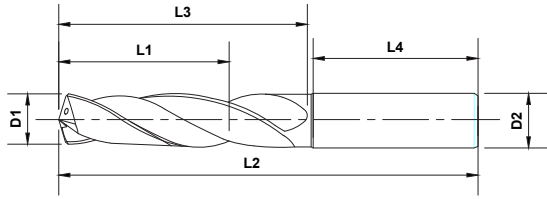

Series 651



Series 651, PowerA



OD	LOC	LOF	SHK	SHK-L	OAL	Uncoated		PowerA	
D1	L1	L3	D2	L4	L2	Non-Coolant Through	Coolant Through	Non-Coolant Through	Coolant Through
.1181	0.905	1.102	.2362	1.417	2.59	751-002	-	751-002-1	-
.1220	0.905	1.102	.2362	1.417	2.59	751-004	-	751-004-1	-
.1248	0.905	1.102	.2362	1.417	2.59	751-006	-	751-006-1	-
1/8	0.905	1.102	.2362	1.417	2.59	751-008	-	751-008-1	-
.1260	0.905	1.102	.2362	1.417	2.59	751-010	-	751-010-1	-
.1280	0.905	1.102	.2362	1.417	2.59	751-012	-	751-012-1	-
.1299	0.905	1.102	.2362	1.417	2.59	751-014	-	751-014-1	-
.1339	0.905	1.102	.2362	1.417	2.59	751-016	751-516	751-016-1	751-516-1
.1378	0.905	1.102	.2362	1.417	2.59	751-018	751-518	751-018-1	751-518-1
9/64	0.905	1.102	.2362	1.417	2.59	751-022	751-522	751-022-1	751-522-1
.1417	0.905	1.102	.2362	1.417	2.59	751-024	751-524	751-024-1	751-524-1
.1457	0.905	1.102	.2362	1.417	2.59	751-026	751-526	751-026-1	751-526-1
.1496	1.141	1.417	.2362	1.417	2.91	751-028	751-528	751-028-1	751-528-1
.1535	1.141	1.417	.2362	1.417	2.91	751-030	751-530	751-030-1	751-530-1
5/32	1.141	1.417	.2362	1.417	2.91	751-032	751-532	751-032-1	751-532-1
.1575	1.141	1.417	.2362	1.417	2.91	751-036	751-536	751-036-1	751-536-1
.1614	1.141	1.417	.2362	1.417	2.91	751-038	751-538	751-038-1	751-538-1
.1654	1.141	1.417	.2362	1.417	2.91	751-040	751-540	751-040-1	751-540-1

* For extreme performance drilling, try our PowerNR coating. Use the uncoated part number and add -8.

HURRICANE DRILLS - 5xD

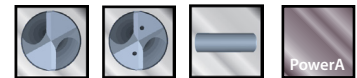

HIGH PERFORMANCE DRILLS

5xD • 2 FL, 140° Point and 30° Helix • Coated and Uncoated

- High Performance A-Gr-SiV submicron grain carbide
- Coolant and non-coolant through
- Rigid design for fast feed rates
- MAP certified quality

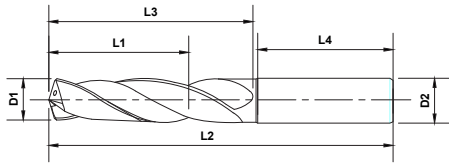

OD	LOC	LOF	SHK	SHK-L	OAL	Uncoated		PowerA	
						Non-Coolant Through	Coolant Through	Non-Coolant Through	Coolant Through
D1	L1	L3	D2	L4	L2				
.1693	1.141	1.417	.2362	1.417	2.91	751-042	751-542	751-042-1	751-542-1
11/64	1.141	1.417	.2362	1.417	2.91	751-044	751-544	751-044-1	751-544-1
.1720	1.141	1.417	.2362	1.417	2.91	751-046	751-546	751-046-1	751-546-1
.1732	1.141	1.417	.2362	1.417	2.91	751-048	751-548	751-048-1	751-548-1
.1772	1.141	1.417	.2362	1.417	2.91	751-050	751-550	751-050-1	751-550-1
.1811	1.141	1.417	.2362	1.417	2.91	751-052	751-552	751-052-1	751-552-1
.1831	1.141	1.417	.2362	1.417	2.91	751-054	751-554	751-054-1	751-554-1
.1850	1.377	1.732	.2362	1.417	3.22	751-056	751-556	751-056-1	751-556-1
.1874	1.377	1.732	.2362	1.417	3.22	751-058	751-558	751-058-1	751-558-1
3/16	1.377	1.732	.2362	1.417	3.22	751-060	751-560	751-060-1	751-560-1
.1890	1.377	1.732	.2362	1.417	3.22	751-062	751-562	751-062-1	751-562-1
.1929	1.377	1.732	.2362	1.417	3.22	751-064	751-564	751-064-1	751-564-1
.1969	1.377	1.732	.2362	1.417	3.22	751-066	751-566	751-066-1	751-566-1
.2008	1.377	1.732	.2362	1.417	3.22	751-068	751-568	751-068-1	751-568-1
13/64	1.377	1.732	.2362	1.417	3.22	751-070	751-570	751-070-1	751-570-1
.2047	1.377	1.732	.2362	1.417	3.22	751-074	751-574	751-074-1	751-574-1
.2087	1.377	1.732	.2362	1.417	3.22	751-076	751-576	751-076-1	751-576-1
.2126	1.377	1.732	.2362	1.417	3.22	751-078	751-578	751-078-1	751-578-1
.2165	1.377	1.732	.2362	1.417	3.22	751-080	751-580	751-080-1	751-580-1
.2185	1.377	1.732	.2362	1.417	3.22	751-082	751-582	751-082-1	751-582-1
7/32	1.377	1.732	.2362	1.417	3.22	751-084	751-584	751-084-1	751-584-1
.2189	1.377	1.732	.2362	1.417	3.22	751-086	751-586	751-086-1	751-586-1
.2205	1.377	1.732	.2362	1.417	3.22	751-088	751-588	751-088-1	751-588-1
.2244	1.377	1.732	.2362	1.417	3.22	751-090	751-590	751-090-1	751-590-1
.2283	1.377	1.732	.2362	1.417	3.22	751-092	751-592	751-092-1	751-592-1
.2323	1.377	1.732	.2362	1.417	3.22	751-094	751-594	751-094-1	751-594-1
.2343	1.377	1.732	.2362	1.417	3.22	751-096	751-596	751-096-1	751-596-1
15/64	1.377	1.732	.2362	1.417	3.22	751-098	751-598	751-098-1	751-598-1

* For extreme performance drilling, try our PowerNR coating. Use the uncoated part number and add -8.

High Performance Drills



HURRICANE DRILLS - 5xD

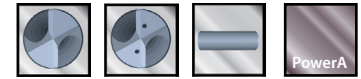

HIGH PERFORMANCE DRILLS

5xD • 2 FL, 140° Point and 30° Helix • Coated and Uncoated

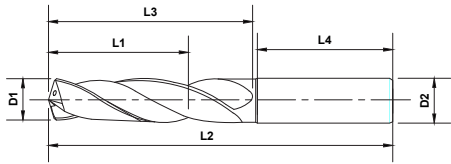

- High Performance A-Gr-SiV submicron grain carbide
- Coolant and non-coolant through
- Rigid design for fast feed rates
- MAP certified quality



OD	LOC	LOF	SHK	SHK-L	OAL	Uncoated		PowerA	
D1	L1	L3	D2	L4	L2	Non-Coolant Through	Coolant Through	Non-Coolant Through	Coolant Through
.2362	1.377	1.732	.2362	1.417	3.22	751-100	751-600	751-100-1	751-600-1
.2402	1.692	2.086	.3150	1.417	3.58	751-102	751-602	751-102-1	751-602-1
.2441	1.692	2.086	.3150	1.417	3.58	751-104	751-604	751-104-1	751-604-1
.2480	1.692	2.086	.3150	1.417	3.58	751-106	751-606	751-106-1	751-606-1
1/4	1.692	2.086	.3150	1.417	3.58	751-108	751-608	751-108-1	751-608-1
.2520	1.692	2.086	.3150	1.417	3.58	751-110	751-610	751-110-1	751-610-1
.2559	1.692	2.086	.3150	1.417	3.58	751-112	751-612	751-112-1	751-612-1
.2598	1.692	2.086	.3150	1.417	3.58	751-114	751-614	751-114-1	751-614-1
.2638	1.692	2.086	.3150	1.417	3.58	751-116	751-616	751-116-1	751-616-1
17/64	1.692	2.086	.3150	1.417	3.58	751-118	751-618	751-118-1	751-618-1
.2657	1.692	2.086	.3150	1.417	3.58	751-120	751-620	751-120-1	751-620-1
.2677	1.692	2.086	.3150	1.417	3.58	751-122	751-622	751-122-1	751-622-1
.2717	1.692	2.086	.3150	1.417	3.58	751-124	751-624	751-124-1	751-624-1
.2756	1.692	2.086	.3150	1.417	3.58	751-126	751-626	751-126-1	751-626-1
.2795	1.692	2.086	.3150	1.417	3.58	751-128	751-628	751-128-1	751-628-1
.2811	1.692	2.086	.3150	1.417	3.58	751-130	751-630	751-130-1	751-630-1
9/32	1.692	2.086	.3150	1.417	3.58	751-132	751-632	751-132-1	751-632-1
.2835	1.692	2.086	.3150	1.417	3.58	751-134	751-634	751-134-1	751-634-1
.2874	1.692	2.086	.3150	1.417	3.58	751-136	751-636	751-136-1	751-636-1
.2913	1.692	2.086	.3150	1.417	3.58	751-138	751-638	751-138-1	751-638-1
.2953	1.692	2.086	.3150	1.417	3.58	751-140	751-640	751-140-1	751-640-1
19/64	1.692	2.086	.3150	1.417	3.58	751-144	751-644	751-144-1	751-644-1
.2992	1.692	2.086	.3150	1.417	3.58	751-146	751-646	751-146-1	751-646-1
.3031	1.692	2.086	.3150	1.417	3.58	751-148	751-648	751-148-1	751-648-1
.3071	1.692	2.086	.3150	1.417	3.58	751-150	751-650	751-150-1	751-650-1
.3110	1.692	2.086	.3150	1.417	3.58	751-152	751-652	751-152-1	751-652-1
5/16	1.692	2.086	.3150	1.417	3.58	751-154	751-654	751-154-1	751-654-1
.3126	1.692	2.086	.3150	1.417	3.58	751-156	751-656	751-156-1	751-656-1

* For extreme performance drilling, try our PowerNR coating. Use the uncoated part number and add -8.

HURRICANE DRILLS - 5xD

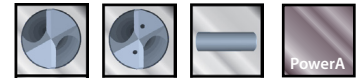

HIGH PERFORMANCE DRILLS

5xD • 2 FL, 140° Point and 30° Helix • Coated and Uncoated

- High Performance A-Gr-SiV submicron grain carbide
- Coolant and non-coolant through
- Rigid design for fast feed rates
- MAP certified quality

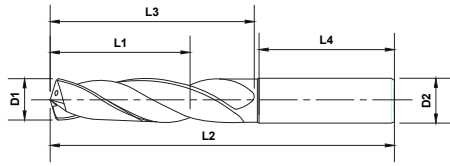

OD	LOC	LOF	SHK	SHK-L	OAL	Uncoated		PowerA	
						Non-Coolant Through	Coolant Through	Non-Coolant Through	Coolant Through
D1	L1	L3	D2	L4	L2				
.3150	1.692	2.086	.3150	1.417	3.58	751-158	751-658	751-158-1	751-658-1
.3189	1.929	2.401	.3937	1.575	4.05	751-160	751-660	751-160-1	751-660-1
.3228	1.929	2.401	.3937	1.575	4.05	751-162	751-662	751-162-1	751-662-1
.3268	1.929	2.401	.3937	1.575	4.05	751-164	751-664	751-164-1	751-664-1
.3280	1.929	2.401	.3937	1.575	4.05	751-166	751-666	751-166-1	751-666-1
21/64	1.929	2.401	.3937	1.575	4.05	751-168	751-668	751-168-1	751-668-1
.3307	1.929	2.401	.3937	1.575	4.05	751-170	751-670	751-170-1	751-670-1
.3346	1.929	2.401	.3937	1.575	4.05	751-172	751-672	751-172-1	751-672-1
.3386	1.929	2.401	.3937	1.575	4.05	751-174	751-674	751-174-1	751-674-1
.3425	1.929	2.401	.3937	1.575	4.05	751-176	751-676	751-176-1	751-676-1
11/32	1.929	2.401	.3937	1.575	4.05	751-180	751-680	751-180-1	751-680-1
.3465	1.929	2.401	.3937	1.575	4.05	751-182	751-682	751-182-1	751-682-1
.3504	1.929	2.401	.3937	1.575	4.05	751-184	751-684	751-184-1	751-684-1
.3543	1.929	2.401	.3937	1.575	4.05	751-186	751-686	751-186-1	751-686-1
.3583	1.929	2.401	.3937	1.575	4.05	751-188	751-688	751-188-1	751-688-1
23/64	1.929	2.401	.3937	1.575	4.05	751-190	751-690	751-190-1	751-690-1
.3622	1.929	2.401	.3937	1.575	4.05	751-194	751-694	751-194-1	751-694-1
.3642	1.929	2.401	.3937	1.575	4.05	751-196	751-696	751-196-1	751-696-1
.3661	1.929	2.401	.3937	1.575	4.05	751-198	751-698	751-198-1	751-698-1
.3701	1.929	2.401	.3937	1.575	4.05	751-200	751-700	751-200-1	751-700-1
.3740	1.929	2.401	.3937	1.575	4.05	751-202	751-702	751-202-1	751-702-1
.3748	1.929	2.401	.3937	1.575	4.05	751-204	751-704	751-204-1	751-704-1
3/8	1.929	2.401	.3937	1.575	4.05	751-206	751-706	751-206-1	751-706-1
.3780	1.929	2.401	.3937	1.575	4.05	751-208	751-708	751-208-1	751-708-1
.3819	1.929	2.401	.3937	1.575	4.05	751-210	751-710	751-210-1	751-710-1
.3858	1.929	2.401	.3937	1.575	4.05	751-212	751-712	751-212-1	751-712-1
.3898	1.929	2.401	.3937	1.575	4.05	751-214	751-714	751-214-1	751-714-1
25/64	1.929	2.401	.3937	1.575	4.05	751-218	751-718	751-218-1	751-718-1

* For extreme performance drilling, try our PowerNR coating. Use the uncoated part number and add -8.

High Performance Drills



HURRICANE DRILLS - 5xD

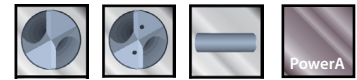

HIGH PERFORMANCE DRILLS

5xD • 2 FL, 140° Point and 30° Helix • Coated and Uncoated

- High Performance A-Gr-SiV submicron grain carbide
- Coolant and non-coolant through
- Rigid design for fast feed rates
- MAP certified quality

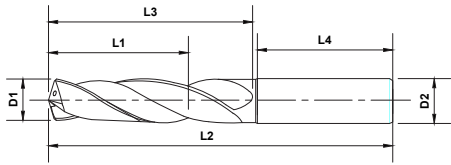

OD	LOC	LOF	SHK	SHK-L	OAL	Uncoated		PowerA	
D1	L1	L3	D2	L4	L2	Non-Coolant Through	Coolant Through	Non-Coolant Through	Coolant Through
.3937	1.929	2.401	.3937	1.575	4.05	751-220	751-720	751-220-1	751-720-1
.3976	2.204	2.795	.4724	1.772	4.64	751-222	751-722	751-222-1	751-722-1
.4016	2.204	2.795	.4724	1.772	4.64	751-224	751-724	751-224-1	751-724-1
.4055	2.204	2.795	.4724	1.772	4.64	751-226	751-726	751-226-1	751-726-1
13/32	2.204	2.795	.4724	1.772	4.64	751-228	751-728	751-228-1	751-728-1
.4094	2.204	2.795	.4724	1.772	4.64	751-232	751-732	751-232-1	751-732-1
.4134	2.204	2.795	.4724	1.772	4.64	751-234	751-734	751-234-1	751-734-1
.4173	2.204	2.795	.4724	1.772	4.64	751-236	751-736	751-236-1	751-736-1
.4213	2.204	2.795	.4724	1.772	4.64	751-238	751-738	751-238-1	751-738-1
27/64	2.204	2.795	.4724	1.772	4.64	751-240	751-740	751-240-1	751-740-1
.4252	2.204	2.795	.4724	1.772	4.64	751-242	751-742	751-242-1	751-742-1
.4291	2.204	2.795	.4724	1.772	4.64	751-244	751-744	751-244-1	751-744-1
.4331	2.204	2.795	.4724	1.772	4.64	751-246	751-746	751-246-1	751-746-1
.4374	2.204	2.795	.4724	1.772	4.64	751-250	751-748	751-250-1	751-748-1
7/16	2.204	2.795	.4724	1.772	4.64	751-252	751-752	751-252-1	751-752-1
.4409	2.204	2.795	.4724	1.772	4.64	751-254	751-754	751-254-1	751-754-1
.4449	2.204	2.795	.4724	1.772	4.64	751-256	751-756	751-256-1	751-756-1
.4488	2.204	2.795	.4724	1.772	4.64	751-258	751-758	751-258-1	751-758-1
.4528	2.204	2.795	.4724	1.772	4.64	751-260	751-760	751-260-1	751-760-1
29/64	2.204	2.795	.4724	1.772	4.64	751-262	751-762	751-262-1	751-762-1
.4567	2.204	2.795	.4724	1.772	4.64	751-264	751-764	751-264-1	751-764-1
.4606	2.204	2.795	.4724	1.772	4.64	751-266	751-766	751-266-1	751-766-1
.4646	2.204	2.795	.4724	1.772	4.64	751-268	751-768	751-268-1	751-768-1
15/32	2.204	2.795	.4724	1.772	4.64	751-272	751-772	751-272-1	751-772-1
.4689	2.204	2.795	.4724	1.772	4.64	751-274	751-774	751-274-1	751-774-1
.4724	2.204	2.795	.4724	1.772	4.64	751-276	751-776	751-276-1	751-776-1
31/64	2.362	2.795	.5512	1.772	4.64	751-278	751-778	751-278-1	751-778-1

* For extreme performance drilling, try our PowerNR coating. Use the uncoated part number and add -8.

HURRICANE DRILLS - 5xD

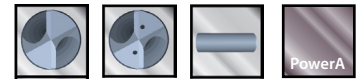

HIGH PERFORMANCE DRILLS

5xD, 2 FL, 140° Point and 30° Helix • Coated and Uncoated

- High Performance A-Gr-SiV submicron grain carbide
- Coolant and non-coolant through
- Rigid design for fast feed rates
- MAP certified quality

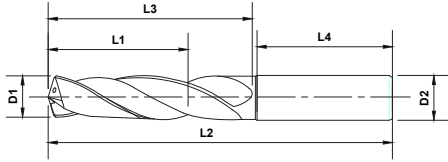

OD	LOC	LOF	SHK	SHK-L	OAL	Uncoated		PowerA	
						Non-Coolant Through	Coolant Through	Non-Coolant Through	Coolant Through
D1	L1	L3	D2	L4	L2				
.4921	2.362	3.031	.5512	1.772	4.88	751-280	751-780	751-280-1	751-780-1
1/2	2.362	3.031	.5512	1.772	4.88	751-284	751-784	751-284-1	751-784-1
.5118	2.362	3.031	.5512	1.772	4.88	751-286	751-786	751-286-1	751-786-1
17/32	2.362	3.03	.5512	1.772	4.88	751-288	751-788	751-288-1	751-788-1
.5315	2.362	3.031	.5512	1.772	4.88	751-290	751-790	751-290-1	751-790-1
.5394	2.362	3.031	.5512	1.772	4.88	751-292	751-792	751-292-1	751-792-1
.5512	2.362	3.031	.5512	1.772	4.88	751-296	751-796	751-296-1	751-796-1
9/16	2.480	3.267	.6299	1.889	5.23	751-302	751-800	751-302-1	751-800-1
.5709	2.480	3.267	.6299	1.889	5.23	751-304	751-804	751-304-1	751-804-1
37/64	2.480	3.267	.6299	1.889	5.23	751-306	751-806	751-306-1	751-806-1
.5787	2.480	3.267	.6299	1.889	5.23	751-308	751-808	751-308-1	751-808-1
.5906	2.480	3.267	.6299	1.889	5.23	751-310	751-810	751-310-1	751-810-1
39/64	2.480	3.267	.6299	1.889	5.23	751-312	751-812	751-312-1	751-812-1
.6102	2.480	3.267	.6299	1.889	5.23	751-314	751-814	751-314-1	751-814-1
.6181	2.480	3.267	.6299	1.889	5.23	751-316	751-816	751-316-1	751-816-1
5/8	2.480	3.267	.6299	1.889	5.23	751-318	751-818	751-318-1	751-818-1
.6299	2.480	3.267	.6299	1.889	5.23	751-320	751-820	751-320-1	751-820-1
.6496	2.795	3.661	.7087	1.889	5.62	751-322	751-822	751-322-1	751-822-1
.6693	2.795	3.661	.7087	1.889	5.62	751-324	751-824	751-324-1	751-824-1
.6890	2.795	3.661	.7087	1.889	5.62	751-326	751-826	751-326-1	751-826-1
.7087	2.795	3.661	.7087	1.889	5.62	751-328	751-828	751-328-1	751-828-1
.7283	3.031	3.976	.7874	1.969	6.02	751-330	751-830	751-330-1	751-830-1
.7480	3.031	3.976	.7874	1.969	6.02	751-332	751-832	751-332-1	751-832-1
.7677	3.031	3.976	.7874	1.969	6.02	751-334	751-834	751-334-1	751-834-1
.7874	3.031	3.976	.7874	1.969	6.02	751-336	751-836	751-336-1	751-836-1

* For extreme performance drilling, try our PowerNR coating. Use the uncoated part number and add -8.

High Performance Drills

HURRICANE DRILLS - 8xD



HIGH PERFORMANCE DRILLS

8xD • 2 FL, 140° Point and 30° Helix • Coated and Uncoated

- High Performance A-Gr-SiV submicron grain carbide
- Coolant through
- Rigid design for fast feed rates
- MAP certified quality

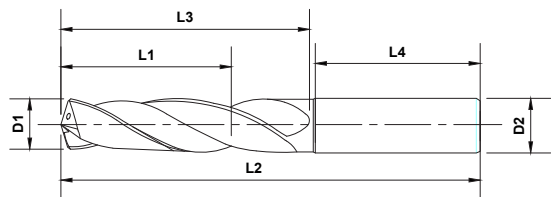

Series 652



Series 652, PowerA



OD	LOC	LOF	SHK	SHK-L	OAL	Uncoated	PowerA
D1	L1	L3	D2	L4	L2	Coolant Through	Coolant Through
.1339	1.141	1.338	.2362	1.3386	2.83	752-512	752-512-1
.1378	1.141	1.338	.2362	1.3386	2.83	752-514	752-514-1
9/64	1.141	1.338	.2362	1.3386	2.83	752-516	752-516-1
.1417	1.141	1.338	.2362	1.3386	2.83	752-518	752-518-1
.1457	1.141	1.338	.2362	1.3386	2.83	752-520	752-520-1
.1496	1.417	1.692	.2362	1.3386	3.18	752-522	752-522-1
.1535	1.417	1.692	.2362	1.3386	3.18	752-524	752-524-1
5/32	1.417	1.692	.2362	1.3386	3.18	752-526	752-526-1
.1575	1.417	1.692	.2362	1.3386	3.18	752-528	752-528-1
.1614	1.417	1.692	.2362	1.3386	3.18	752-530	752-530-1
.1654	1.417	1.692	.2362	1.3386	3.18	752-532	752-532-1
.1693	1.417	1.692	.2362	1.3386	3.18	752-534	752-534-1
11/64	1.417	1.692	.2362	1.3386	3.18	752-536	752-536-1
.1732	1.417	1.692	.2362	1.3386	3.18	752-538	752-538-1
.1772	1.417	1.692	.2362	1.3386	3.18	752-540	752-540-1
.1811	1.417	1.692	.2362	1.3386	3.18	752-542	752-542-1
.1850	1.417	1.692	.2362	1.3386	3.18	752-544	752-544-1
3/16	1.417	1.692	.2362	1.3386	3.18	752-546	752-546-1
.1890	2.086	2.244	.2362	1.3386	3.74	752-548	752-548-1
.1929	2.086	2.244	.2362	1.3386	3.74	752-550	752-550-1
.1969	2.086	2.244	.2362	1.4173	3.74	752-552	752-552-1
.2008	2.086	2.244	.2362	1.4173	3.74	752-554	752-554-1
13/64	2.086	2.244	.2362	1.4173	3.74	752-556	752-556-1
.2047	2.086	2.244	.2362	1.4173	3.74	752-558	752-558-1
.2087	2.086	2.244	.2362	1.4173	3.74	752-560	752-560-1

HURRICANE DRILLS - 8xD

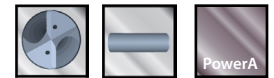

HIGH PERFORMANCE DRILLS

8xD • 2 FL, 140° Point and 30° Helix • Coated and Uncoated

- High Performance A-Gr-SiV submicron grain carbide
- Coolant through
- Rigid design for fast feed rates
- MAP certified quality

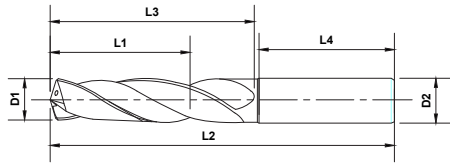

OD	LOC	LOF	SHK	SHK-L	OAL	Uncoated	PowerA
D1	L1	L3	D2	L4	L2	Coolant Through	Coolant Through
.2126	2.086	2.244	.2362	1.4173	3.74	752-562	752-562-1
.2165	2.086	2.244	.2362	1.4173	3.74	752-564	752-564-1
7/32	2.086	2.244	.2362	1.4173	3.74	752-566	752-566-1
.2205	2.086	2.244	.2362	1.4173	3.74	752-568	752-568-1
.2244	2.086	2.244	.2362	1.4173	3.74	752-570	752-570-1
.2283	2.086	2.244	.2362	1.4173	3.74	752-572	752-572-1
.2323	2.086	2.244	.2362	1.4173	3.74	752-574	752-574-1
15/64	2.086	2.244	.2362	1.4173	3.74	752-576	752-576-1
.2362	2.086	2.244	.2362	1.4173	3.74	752-578	752-578-1
.2402	2.598	2.992	.3150	1.4173	4.48	752-580	752-580-1
.2441	2.598	2.992	.3150	1.4173	4.48	752-582	752-582-1
.2480	2.598	2.992	.3150	1.4173	4.48	752-584	752-584-1
1/4	2.598	2.992	.3150	1.4173	4.48	752-586	752-586-1
.2520	2.598	2.992	.3150	1.4173	4.48	752-588	752-588-1
.2559	2.598	2.992	.3150	1.4173	4.48	752-590	752-590-1
.2598	2.598	2.992	.3150	1.4173	4.48	752-592	752-592-1
.2638	2.598	2.992	.3150	1.4173	4.48	752-594	752-594-1
17/64	2.598	2.992	.3150	1.4173	4.48	752-596	752-596-1
.2677	2.598	2.992	.3150	1.4173	4.48	752-598	752-598-1
.2717	2.598	2.992	.3150	1.4173	4.48	752-600	752-600-1
.2756	2.598	2.992	.3150	1.4173	4.48	752-602	752-602-1
.2795	2.598	2.992	.3150	1.4173	4.48	752-604	752-604-1
9/32	2.598	2.992	.3150	1.4173	4.48	752-606	752-606-1
.2835	2.598	2.992	.3150	1.4173	4.48	752-608	752-608-1
.2874	2.598	2.992	.3150	1.4173	4.48	752-610	752-610-1
.2913	2.598	2.992	.3150	1.4173	4.48	752-612	752-612-1
.2953	2.598	2.992	.3150	1.4173	4.48	752-614	752-614-1
19/64	2.598	2.992	.3150	1.4173	4.48	752-616	752-616-1
.2992	2.598	2.992	.3150	1.4173	4.48	752-618	752-618-1
.3031	2.598	2.992	.3150	1.4173	4.48	752-620	752-620-1
.3071	2.598	2.992	.3150	1.4173	4.48	752-622	752-622-1
.3110	2.598	2.992	.3150	1.4173	4.48	752-624	752-624-1
5/16	2.598	2.992	.3150	1.4173	4.48	752-626	752-626-1
.3150	2.598	2.992	.3150	1.4173	4.48	752-628	752-628-1
.3189	3.346	3.740	.3937	1.771	5.59	752-630	752-630-1
.3228	3.346	3.740	.3937	1.771	5.59	752-632	752-632-1

High Performance Drills

HURRICANE DRILLS - 8xD

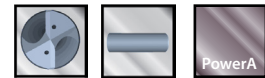

HIGH PERFORMANCE DRILLS

8xD • 2 FL, 140° Point and 30° Helix • Coated and Uncoated

- High Performance A-Gr-SiV submicron grain carbide
- Coolant through
- Rigid design for fast feed rates
- MAP certified quality

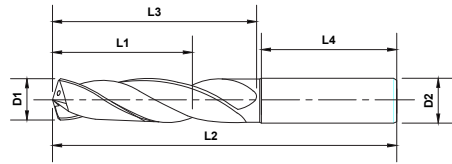

OD	LOC	LOF	SHK	SHK-L	OAL	Uncoated	PowerA
D1	L1	L3	D2	L4	L2	Coolant Through	Coolant Through
.3268	3.346	3.740	.3937	1.771	5.59	752-634	752-634-1
21/64	3.346	3.740	.3937	1.771	5.59	752-636	752-636-1
.3307	3.346	3.740	.3937	1.771	5.59	752-638	752-638-1
.3346	3.346	3.740	.3937	1.771	5.59	752-640	752-640-1
.3386	3.346	3.740	.3937	1.771	5.59	752-642	752-642-1
.3425	3.346	3.740	.3937	1.771	5.59	752-644	752-644-1
11/32	3.346	3.740	.3937	1.771	5.59	752-646	752-646-1
.3465	3.346	3.740	.3937	1.771	5.59	752-648	752-648-1
.3504	3.346	3.740	.3937	1.771	5.59	752-650	752-650-1
.3543	3.346	3.740	.3937	1.771	5.59	752-652	752-652-1
.3583	3.346	3.740	.3937	1.771	5.59	752-654	752-654-1
23/64	3.346	3.740	.3937	1.771	5.59	752-656	752-656-1
.3622	3.346	3.740	.3937	1.771	5.59	752-658	752-658-1
.3661	3.346	3.740	.3937	1.771	5.59	752-660	752-660-1
.3701	3.346	3.740	.3937	1.771	5.59	752-662	752-662-1
.3740	3.346	3.740	.3937	1.771	5.59	752-664	752-664-1
.3748	3.346	3.740	.3937	1.771	5.59	752-666	752-666-1
3/8	3.346	3.740	.3937	1.771	5.59	752-668	752-668-1
.3780	3.346	3.740	.3937	1.771	5.59	752-670	752-670-1
.3819	3.346	3.740	.3937	1.771	5.59	752-672	752-672-1
.3858	3.346	3.740	.3937	1.771	5.59	752-674	752-674-1
.3898	3.346	3.740	.3937	1.771	5.59	752-676	752-676-1
25/64	3.346	3.740	.3937	1.771	5.59	752-678	752-678-1
.3937	3.346	3.740	.3937	1.771	5.59	752-680	752-680-1
.3976	3.897	4.488	.4724	1.810	6.37	752-682	752-682-1
.4016	3.897	4.488	.4724	1.810	6.37	752-684	752-684-1
.4055	3.897	4.488	.4724	1.810	6.37	752-686	752-686-1
13/32	3.897	4.488	.4724	1.810	6.37	752-688	752-688-1
.4094	3.897	4.488	.4724	1.810	6.37	752-690	752-690-1
.4134	3.897	4.488	.4724	1.810	6.37	752-692	752-692-1
.4173	3.897	4.488	.4724	1.810	6.37	752-694	752-694-1
.4213	3.897	4.488	.4724	1.810	6.37	752-696	752-696-1
.4218	3.897	4.488	.4724	1.810	6.37	752-698	752-698-1
.4252	3.897	4.488	.4724	1.810	6.37	752-700	752-700-1
.4291	3.897	4.488	.4724	1.810	6.37	752-702	752-702-1

HURRICANE DRILLS - 8xD

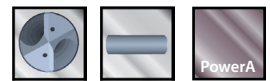

HIGH PERFORMANCE DRILLS

8xD • 2 FL, 140° Point and 30° Helix • Coated and Uncoated

- High Performance A-Gr-SiV submicron grain carbide
- Coolant through
- Rigid design for fast feed rates
- MAP certified quality

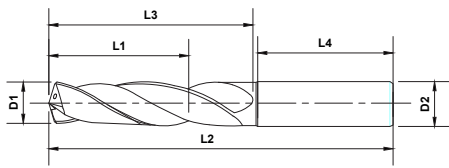

OD	LOC	LOF	SHK	SHK-L	OAL	Uncoated	PowerA
D1	L1	L3	D2	L4	L2	Coolant Through	Coolant Through
.4331	3.897	4.488	.4724	1.810	6.37	752-704	752-704-1
.4370	3.897	4.488	.4724	1.810	6.37	752-706	752-706-1
7/16	3.897	4.488	.4724	1.810	6.37	752-708	752-708-1
.4409	3.897	4.488	.4724	1.810	6.37	752-710	752-710-1
.4449	3.897	4.488	.4724	1.810	6.37	752-712	752-712-1
.4488	3.897	4.488	.4724	1.810	6.37	752-714	752-714-1
.4528	3.897	4.488	.4724	1.810	6.37	752-716	752-716-1
.4531	3.897	4.488	.4724	1.810	6.37	752-718	752-718-1
.4567	3.897	4.488	.4724	1.810	6.37	752-720	752-720-1
.4606	3.897	4.488	.4724	1.810	6.37	752-722	752-722-1
.4646	3.897	4.488	.4724	1.810	6.37	752-724	752-724-1
.4685	3.897	4.488	.4724	1.810	6.37	752-726	752-726-1
15/32	3.897	4.488	.4724	1.810	6.37	752-728	752-728-1
.4724	3.897	4.488	.4724	1.810	6.37	752-730	752-730-1
31/64	3.897	4.488	.5512	1.850	6.37	752-732	752-732-1
.4921	4.566	5.236	.5512	1.850	7.16	752-734	752-734-1
1/2	4.566	5.236	.5512	1.850	7.16	752-736	752-736-1
.5118	4.566	5.236	.5512	1.850	7.16	752-738	752-738-1
.5315	4.566	5.236	.5512	1.850	7.16	752-740	752-740-1
.5512	4.566	5.236	.5512	1.850	7.16	752-742	752-742-1
.5709	5.196	5.984	.6299	1.969	8.03	752-744	752-744-1
.5906	5.196	5.984	.6299	1.969	8.03	752-746	752-746-1
.6102	5.196	5.984	.6299	1.969	8.03	752-748	752-748-1
.6299	5.196	5.984	.6299	1.969	8.03	752-750	752-750-1
.6496	5.886	6.732	.7087	1.969	8.77	752-752	752-752-1
.6693	5.886	6.732	.7087	1.969	8.77	752-754	752-754-1
.6890	5.886	6.732	.7087	1.969	8.77	752-756	752-756-1
.7087	5.886	6.732	.7087	1.969	8.77	752-758	752-758-1
.7283	6.535	7.480	.7874	2.047	9.60	752-760	752-760-1
.7480	6.535	7.480	.7874	2.047	9.60	752-762	752-762-1
3/4	6.535	7.480	.7874	2.047	9.60	752-764	752-764-1
.7677	6.535	7.480	.7874	2.047	9.60	752-766	752-766-1
.7874	6.535	7.480	.7874	2.047	9.60	752-768	752-768-1

High Performance Drills

CHUCKING REAMERS

Solid Carbide

- 45° Corner Lead
- Four or Six Flutes

ISO 9001:2015
CERTIFIED



In 2003, Mastercut Tool Corp. successfully achieved registration under ISO 9001:2000 and has maintained our quality system to our current ISO 9001:2015 certification and Lean Six Sigma practices. We maintain these strict standards to further guarantee that every tool you buy from Mastercut Tool Corp. is of the highest quality.

TABLE OF CONTENTS



Straight Flute Reamers - 4 Flute 158





Straight Flute Reamers - 6 Flute 159



General Purpose ferrous and non-ferrous compatible. Right hand cutting.

Features Legend

	4 Flutes
	6 Flutes
	Plain shank

Mastercut's Superior Carbide Blend – *A-Gr-SiV* (Active Grain Sized Volume)

Our superior tungsten carbide gives you the ability to be *aggressive* when you need to be. Growth inhibitors in our sub-micron carbide blanks maintain the most consistent grain size available, giving you superior hardness AND toughness.

Please contact us for our full line of metric products.

CHUCKING REAMERS - STRAIGHT FLUTE

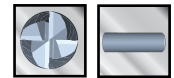

- Genuine A-Gr-SiV submicron grain carbide
- Proven, versatile performance
- MAP certified quality

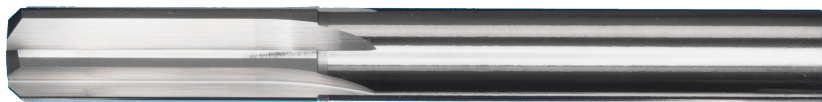
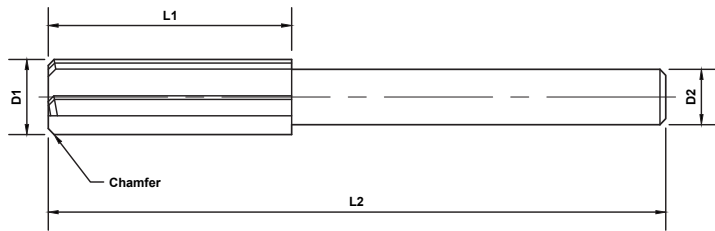

4 Flutes, Series 645



6 Flutes, Series 645

4 FLUTE REAMERS

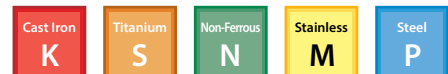

OD	LOC	SHK	OAL		
D1	L1	D2	L2	Flutes	Uncoated
.1250	5/8	7/64	2-1/4	4	645-151
.1285	3/4	1/8	2-1/2	4	645-159
.1290	3/4	1/8	2-1/2	4	645-160
.1360	3/4	1/8	2-1/2	4	645-174
.1378	3/4	1/8	2-1/2	4	645-178
.1405	3/4	1/8	2-1/2	4	645-185
.1406	3/4	1/8	2-1/2	4	645-186
.1440	3/4	1/8	2-1/2	4	645-193
.1470	3/4	9/64	2-1/2	4	645-199
.1495	3/4	9/64	2-1/2	4	645-204
.1520	3/4	9/64	2-1/2	4	645-209
.1540	3/4	9/64	2-1/2	4	645-213
.1562	3/4	9/64	2-1/2	4	645-218
.1570	3/4	9/64	2-1/2	4	645-220
.1575	3/4	9/64	2-1/2	4	645-221

OD	LOC	SHK	OAL		
D1	L1	D2	L2	Flutes	Uncoated
.1590	3/4	9/64	2-1/2	4	645-224
.1595	7/8	5/32	2-3/4	4	645-225
.1610	7/8	5/32	2-3/4	4	645-229
.1660	7/8	5/32	2-3/4	4	645-239
.1695	7/8	5/32	2-3/4	4	645-246
.1719	7/8	5/32	2-3/4	4	645-251
.1730	7/8	5/32	2-3/4	4	645-254
.1770	7/8	11/64	2-3/4	4	645-263
.1772	7/8	11/64	2-3/4	4	645-264
.1800	7/8	11/64	2-3/4	4	645-270
.1820	7/8	11/64	2-3/4	4	645-274
.1850	7/8	11/64	2-3/4	4	645-280
.1875	7/8	11/64	2-3/4	4	645-287
.1890	7/8	11/64	2-3/4	4	645-292
.1910	7/8	11/64	2-3/4	4	645-296

Call for other available sizes

CHUCKING REAMERS - STRAIGHT FLUTE

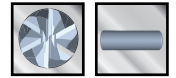

45° Corner Chamfer

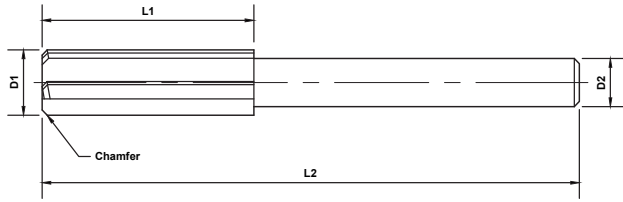

- Genuine A-Gr-SIV submicron grain carbide
- Proven, versatile performance
- MAP certified quality

6 FLUTE REAMERS



OD	LOC	SHK	OAL		
D1	L1	D2	L2	Flutes	Uncoated
.1935	1	3/16	3	6	645-301
.1960	1	3/16	3	6	645-306
.1968	1	3/16	3	6	645-308
.1990	1	3/16	3	6	645-313
.2010	1	3/16	3	6	645-317
.2031	1	3/16	3	6	645-322
.2040	1	3/16	3	6	645-324
.2055	1	3/16	3	6	645-327
.2090	1	3/16	3	6	645-334
.2130	1	3/16	3	6	645-342
.2165	1	3/16	3	6	645-349
.2188	1	3/16	3	6	645-355
.2210	1	3/16	3	6	645-360
.2280	1	7/32	3	6	645-374
.2340	1	7/32	3	6	645-386
.2344	1	7/32	3	6	645-387
.2362	1	7/32	3	6	645-392
.2380	1	7/32	3	6	645-396
.2420	1	7/32	3	6	645-405
.2460	1	7/32	3	6	645-413
.2500	1	7/32	3	6	645-421
.2559	1-1/8	1/4	3-1/4	6	645-435
.2570	1-1/8	1/4	3-1/4	6	645-438
.2610	1-1/8	1/4	3-1/4	6	645-446
.2656	1-1/8	1/4	3-1/4	6	645-456
.2660	1-1/8	1/4	3-1/4	6	645-457
.2720	1-1/8	1/4	3-1/4	6	645-469
.2756	1-1/8	1/4	3-1/4	6	645-477
.2770	1-1/8	1/4	3-1/4	6	645-480
.2810	1-1/8	1/4	3-1/4	6	645-488
.2812	1-1/8	1/4	3-1/4	6	645-489
.2900	1-1/8	9/32	3-1/4	6	645-509
.2950	1-1/8	9/32	3-1/4	6	645-519
.2953	1-1/8	9/32	3-1/4	6	645-520

OD	LOC	SHK	OAL		
D1	L1	D2	L2	Flutes	Uncoated
.2969	1-1/8	9/32	3-1/4	6	645-524
.3020	1-1/8	9/32	3-1/4	6	645-535
.3125	1-1/8	9/32	3-1/4	6	645-556
.3150	1-1/8	9/32	3-1/4	6	645-561
.3160	1-1/8	9/32	3-1/4	6	645-563
.3230	1-1/4	5/16	3-1/2	6	645-578
.3281	1-1/4	5/16	3-1/2	6	645-589
.3320	1-1/4	5/16	3-1/2	6	645-597
.3346	1-1/4	5/16	3-1/2	6	645-603
.3390	1-1/4	5/16	3-1/2	6	645-612
.3438	1-1/4	5/16	3-1/2	6	645-622
.3480	1-1/4	5/16	3-1/2	6	645-631
.3580	1-1/4	11/32	3-1/2	6	645-652
.3594	1-1/4	11/32	3-1/2	6	645-655
.3680	1-1/4	11/32	3-1/2	6	645-674
.3740	1-1/4	11/32	3-1/2	6	645-686
.3750	1-1/4	11/32	3-1/2	6	645-688
.3770	1-1/4	11/32	3-1/2	6	645-692
.3840	1-1/2	3/8	4	6	645-706
.3860	1-1/2	3/8	4	6	645-710
25/64	1-1/2	3/8	4	6	645-719
.3937	1-1/2	3/8	4	6	645-720
.3960	1-1/2	3/8	4	6	645-721
13/32	1-1/2	3/8	4	6	645-722
.4134	1-1/2	13/32	4	6	645-723
27/64	1-1/2	13/32	4	6	645-724
.4331	1-1/2	13/32	4	6	645-725
7/16	1-1/2	13/32	4	6	645-726
.4528	1-1/2	7/16	4	6	645-727
29/64	1-1/2	7/16	4	6	645-728
15/32	1-1/2	7/16	4	6	645-729
.4724	1-1/2	7/16	4	6	645-730
31/64	1-1/2	15/32	4	6	645-732
1/2	1-1/2	15/32	4	6	645-734

Reamers

BURS

- Full Line of Shapes and Cut Types
- Special Purpose and Custom Burs Available

Mastercut's proprietary brazing process gives our burs the extra strength you need to push harder and run faster.

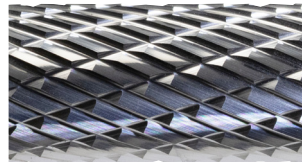

DOUBLECUT (DC)

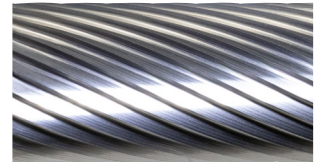

SINGLECUT (SC)

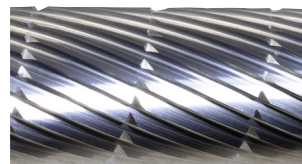

CHIPBREAKER (CB)

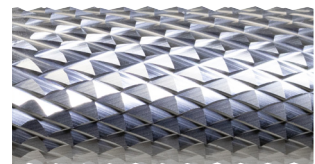

DIAMONDCUT (DM)

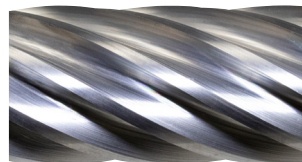





















ALUMACUT (FM)
For Aluminum



NX CUT (NX)
For Stainless Steel



TABLE OF CONTENTS

	SA Burs - Cylindrical Shape, No Endcut	162	Cermet	Hardened	Cast Iron	Titanium	Non-Ferrous	Stainless	Steel
	SB Burs - Cylindrical Shape with End Cut	163	Cermet	Hardened	Cast Iron	Titanium	Non-Ferrous	Stainless	Steel
	SC Burs - Radius Cylindrical Shape	164	Cermet	Hardened	Cast Iron	Titanium	Non-Ferrous	Stainless	Steel
	SD Burs - Ball Shape	165	Cermet	Hardened	Cast Iron	Titanium	Non-Ferrous	Stainless	Steel
	SE Burs - Oval Shape	166	Cermet	Hardened	Cast Iron	Titanium	Non-Ferrous	Stainless	Steel
	SF Burs - Radius Tree Shape	167	Cermet	Hardened	Cast Iron	Titanium	Non-Ferrous	Stainless	Steel
	SG Burs - Pointed Tree Shape.	168	Cermet	Hardened	Cast Iron	Titanium	Non-Ferrous	Stainless	Steel
	SH Burs - Flame Shape	169	Cermet	Hardened	Cast Iron	Titanium	Non-Ferrous	Stainless	Steel
	SJ Burs - 60° Included Cone Shape	170	Cermet	Hardened	Cast Iron	Titanium	Non-Ferrous	Stainless	Steel
	SK Burs - 90° Included Cone Shape	171	Cermet	Hardened	Cast Iron	Titanium	Non-Ferrous	Stainless	Steel
	SL Burs - Radius Cone Shape	172	Cermet	Hardened	Cast Iron	Titanium	Non-Ferrous	Stainless	Steel
	SM Burs - Pointed Cone Shape.	173	Cermet	Hardened	Cast Iron	Titanium	Non-Ferrous	Stainless	Steel
	SN Burs - Inverted Cone Shape	174	Cermet	Hardened	Cast Iron	Titanium	Non-Ferrous	Stainless	Steel
	Die Mills	175	Cermet	Hardened	Cast Iron	Titanium	Non-Ferrous	Stainless	Steel
	Piloted Die Mills	176	Cermet	Hardened	Cast Iron	Titanium	Non-Ferrous	Stainless	Steel
	Fiberglass Routers	176	Fiberglass	Graphite	Composites	Carbon Fiber	Honeycomb		
	Tire Burs	177	NA						
	8-12 Piece Plastic Box Bur Sets	178	Cermet	Hardened	Cast Iron	Titanium	Non-Ferrous	Stainless	Steel
	3-5 Piece Power Pouch Bur Sets	178	Cermet	Hardened	Cast Iron	Titanium	Non-Ferrous	Stainless	Steel
	24 Piece Countertop Displays	179	Cermet	Hardened	Cast Iron	Titanium	Non-Ferrous	Stainless	Steel

General Bur Speed Recommendations

The following chart is a general and approximate recommendation. Variations to achieve desired results may be necessary. Long shank burs should be used at reduced speeds.

Bur Diameter	RPM
1/8" or 3mm Solid Carbide	45,000-50,000
3/16" or 5mm Solid Carbide	35,000-40,000
3/16" or 5mm Carbide Head Brazed to 1/8" or 3mm Steel Shank	30,000-35,000
1/4" or 6mm Solid Carbide	30,000-35,000
1/4" or 6mm Carbide Head Brazed to 1/8" or 3mm Steel Shank	25,000-30,000
5/16" or 8mm Carbide Head Brazed to 1/4" or 6mm Steel Shank	25,000-30,000
3/8" or 10mm Carbide Head Brazed to 1/4" or 6mm Steel Shank	25,000-30,000
7/16" or 11mm Carbide Head Brazed to 1/4" or 6mm Steel Shank	20,000-25,000
1/2" or 12mm Carbide Head Brazed to 1/4" or 6mm Steel Shank	20,000-25,000
5/8" or 16mm Carbide Head Brazed to 1/4" or 6mm Steel Shank	15,000-20,000
3/4" or 18mm Carbide Head Brazed to 1/4" or 6mm Steel Shank	15,000-20,000
1" or 25mm Carbide Head on 1/4" or 6mm Steel Shank	12,000-18,000

SA BURS - CYLINDRICAL SHAPE

Without End Cut

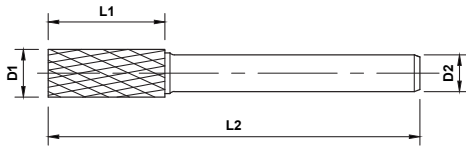

Standard, Singlecut, Series SA-SC



Standard, Doublecut, Series SA-DC



Standard, Alumacut, Series SA-FM



Long, Singlecut, Series SA-SC

Length Key (K)

Standard Long * Solid Carbide

Non-Ferrous **N** Alumacuts recommended for non-ferrous materials

Cast Iron **K** Titanium **S** Stainless **M** Steel **P** Hardened **H**

Quick Ship Items

K	OD	LOC	SHK	OAL	Cut Type					
	D1	L1	D2	L2	Singlecut	Doublecut	Alumacut	Diamondcut	Chipbreaker	NX Cut
*	1/16	1/4	1/8	1-1/2	SA-41SC	SA-41DC	SA-41FM	SA-41DM	SA-41CB	-
*	3/32	7/16	1/8	1-1/2	SA-42SC	SA-42DC	SA-42FM	SA-42DM	SA-42CB	-
*	1/8	9/16	1/8	1-1/2	SA-43SC	SA-43DC	SA-43FM	SA-43DM	SA-43CB	-
*		5/8	1/4	2	SA-12SC	SA-12DC	SA-12FM	SA-12DM	SA-12CB	-
*	3/16	5/8	1/4	2	SA-14SC	SA-14DC	SA-14FM	SA-14DM	SA-14CB	-
		1/2	1/8	2	SA-51SC	SA-51DC	SA-51FM	SA-51DM	SA-51CB	-
*	1/4	5/8	1/4	2	SA-1SC	SA-1DC	SA-1FM	SA-1DM	SA-1CB	-
		5/8	1/4	6-3/4	SA-1L6SC	SA-1L6DC	SA-1L6FM	SA-1L6DM	SA-1L6CB	-
	5/16	3/4	1/4	2-1/2	SA-2SC	SA-2DC	SA-2FM	SA-2DM	SA-2CB	-
	3/8	3/4	1/4	2-1/2	SA-3SC	SA-3DC	SA-3FM	SA-3DM	SA-3CB	SA-3NX
		3/4	1/4	6-3/4	SA-3L6SC	SA-3L6DC	SA-3L6FM	SA-3L6DM	SA-3L6CB	-
	7/16	1	1/4	2-3/4	SA-4SC	SA-4DC	SA-4FM	SA-4DM	SA-4CB	-
		1	1/4	2-3/4	SA-5SC	SA-5DC	SA-5FM	SA-5DM	SA-5CB	SA-5NX
	1/2	1	1/4	7	SA-5L6SC	SA-5L6DC	SA-5L6FM	SA-5L6DM	SA-5L6CB	-
		1	1/4	2-3/4	SA-6SC	SA-6DC	SA-6FM	SA-6DM	SA-6CB	-
	5/8	1	1/4	2-3/4	SA-6SC	SA-6DC	SA-6FM	SA-6DM	SA-6CB	-
		3/4	1/4	2-1/2	SA-16SC	SA-16DC	SA-16FM	SA-16DM	SA-16CB	-
	3/4	1	1/4	2-3/4	SA-7SC	SA-7DC	SA-7FM	SA-7DM	SA-7CB	-
		1	1/4	2-3/4	SA-9SC	SA-9DC	SA-9FM	SA-9DM	SA-9CB	-

SB BURS - CYLINDRICAL SHAPE

With End Cut

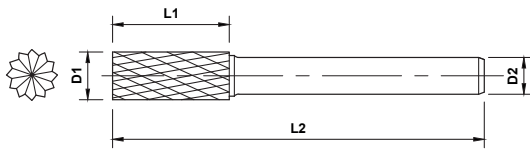

Standard, Singlecut, Series SB-SC

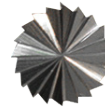

Standard, Doublecut, Series SB-DC

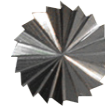

Standard, Alumacut, Series SB-FM



Long, Singlecut, Series SB-SC

Length Key (K)

Standard Long * Solid Carbide

Non-Ferrous Alumacuts recommended for non-ferrous materials

Cast Iron Titanium Stainless Steel Hardened

Quick Ship Items

	OD	LOC	SHK	OAL	Cut Type				
K	D1	L1	D2	L2	Singlecut	Doublecut	Alumacut	Diamondcut	Chipbreaker
*	1/16	1/4	1/8	1-1/2	SB-41SC	SB-41DC	SB-41FM	SB-41DM	SB-41CB
*	3/32	7/16	1/8	1-1/2	SB-42SC	SB-42DC	SB-42FM	SB-42DM	SB-42CB
*	1/8	9/16	1/8	1-1/2	SB-43SC	SB-43DC	SB-43FM	SB-43DM	SB-43CB
*		5/8	1/4	2	SB-12SC	SB-12DC	SB-12FM	SB-12DM	SB-12CB
*	3/16	5/8	1/4	2	SB-14SC	SB-14DC	SB-14FM	SB-14DM	SB-14CB
		3/16	1/8	2-15/16	SB-51SC	SB-51DC	SB-51FM	SB-51DM	SB-51CB
*	1/4	5/8	1/4	2	SB-1SC	SB-1DC	SB-1FM	SB-1DM	SB-1CB
		5/8	1/4	6-3/4	SB-1L6SC	SB-1L6DC	SB-1L6FM	SB-1L6DM	SB-1L6CB
	5/16	3/4	1/4	2-1/2	SB-2SC	SB-2DC	SB-2FM	SB-2DM	SB-2CB
	3/8	3/4	1/4	2-1/2	SB-3SC	SB-3DC	SB-3FM	SB-3DM	SB-3CB
		3/4	1/4	6-3/4	SB-3L6SC	SB-3L6DC	SB-3L6FM	SB-3L6DM	SB-3L6CB
	7/16	1	1/4	2-3/4	SB-4SC	SB-4DC	SB-4FM	SB-4DM	SB-4CB
	1/2	1	1/4	2-3/4	SB-5SC	SB-5DC	SB-5FM	SB-5DM	SB-5CB
		1	1/4	7	SB-5L6SC	SB-5L6DC	SB-5L6FM	SB-5L6DM	SB-5L6CB
	5/8	1	1/4	2-3/4	SB-6SC	SB-6DC	SB-6FM	SB-6DM	SB-6CB
	3/4	3/4	1/4	2-1/2	SB-16SC	SB-16DC	SB-16FM	SB-16DM	SB-16CB
		1	1/4	2-3/4	SB-7SC	SB-7DC	SB-7FM	SB-7DM	SB-7CB
	1	1	1/4	2-3/4	SB-9SC	SB-9DC	SB-9FM	SB-9DM	SB-9CB

SC BURS - RADIUS CYLINDRICAL SHAPE

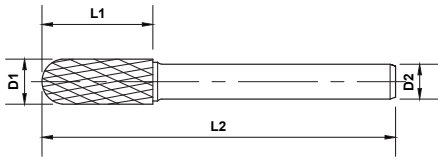

Standard, Singlecut, Series SC-SC



Standard, Doublecut, Series SC-DC



Standard, Alumacut, Series SC-FM Series



Long, Series , Singlecut SC-SC

Length Key (K)

Standard Long * Solid Carbide

Non-Ferrous **N** Alumacuts recommended for non-ferrous materials

Cast Iron **K** Titanium **S** Stainless **M** Steel **P** Hardened **H**

Quick Ship Items

K	OD	LOC	SHK	OAL	Cut Type					
	D1	L1	D2	L2	Singlecut	Doublecut	Alumacut	Diamondcut	Chipbreaker	NX Cut
*	3/32	7/16	1/8	1-1/2	SC-41SC	SC-41DC	SC-41FM	SC-41DM	SC-41CB	-
*	1/8	9/16	1/8	1-1/2	SC-42SC	SC-42DC	SC-42FM	SC-42DM	SC-42CB	-
*		5/8	1/4	2	SC-12SC	SC-12DC	SC-12FM	SC-12DM	SC-12CB	-
*	3/16	5/8	1/4	2	SC-14SC	SC-14DC	SC-14FM	SC-14DM	SC-14CB	-
*		1/2	1/8	2	SC-51SC	SC-51DC	SC-51FM	SC-51DM	SC-51CB	-
*	1/4	5/8	1/4	2	SC-1SC	SC-1DC	SC-1FM	SC-1DM	SC-1CB	-
*		5/8	1/4	6-3/4	SC-1L6SC	SC-1L6DC	SC-1L6FM	SC-1L6DM	SC-1L6CB	-
	5/16	3/4	1/4	2-1/2	SC-2SC	SC-2DC	SC-2FM	SC-2DM	SC-2CB	-
	3/8	3/4	1/4	2-1/2	SC-3SC	SC-3DC	SC-3FM	SC-3DM	SC-3CB	SC-3NX
		3/4	1/4	6-3/4	SC-3L6SC	SC-3L6DC	SC-3L6FM	SC-3L6DM	SC-3L6CB	-
	7/16	1	1/4	2-3/4	SC-4SC	SC-4DC	SC-4FM	SC-4DM	SC-4CB	-
	1/2	1	1/4	2-3/4	SC-5SC	SC-5DC	SC-5FM	SC-5DM	SC-5CB	SC-5NX
		1	1/4	7	SC-5L6SC	SC-5L6DC	SC-5L6FM	SC-5L6DM	SC-5L6CB	-
	5/8	1	1/4	2-3/4	SC-6SC	SC-6DC	SC-6FM	SC-6DM	SC-6CB	-
		1	1/4	7	SC-6L6SC	SC-6L6DC	SC-6L6FM	SC-6L6DM	SC-6L6CB	-
	3/4	1	1/4	2-3/4	SC-7SC	SC-7DC	SC-7FM	SC-7DM	SC-7CB	-

SD BURS - BALL SHAPE

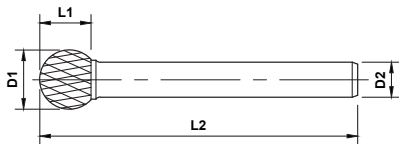

Standard, Singlecut SD-SC Series

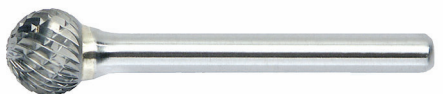

Standard, Doublecut SD-DC Series



Standard, Alumacut SD-FM Series



Long, Singlecut SD-SC Series

Length Key (K)

Standard Long * Solid Carbide

Quick Ship Items

Non-Ferrous **N** Alumacuts recommended for non-ferrous materials

Cast Iron **K** Titanium **S** Stainless **M** Steel **P** Hardened **H**

K	OD	LOC	SHK	OAL	Cut Type					
					Singlecut	Doublecut	Alumacut	Diamondcut	Chipbreaker	NX Cut
*	3/32	3/32	1/8	1-1/2	SD-41SC*	SD-41DC*	SD-41FM*	SD-41DM*	SD-41CB*	-
*	1/8	1/8	1/8	1-1/2	SD-42SC*	SD-42DC*	SD-42FM*	SD-42DM*	SD-42CB*	-
*		3/32	1/4	2	SD-12SC*	SD-12DC*	SD-12FM*	SD-12DM*	SD-12CB*	-
*	3/16	1/8	1/4	2	SD-14SC*	SD-14DC*	SD-14FM*	SD-14DM*	SD-14CB*	-
*		7/32	1/8	1-3/4	SD-51SC	SD-51DC	SD-51FM	SD-51DM	SD-51CB	-
*	1/4	7/32	1/4	2	SD-1SC*	SD-1DC*	SD-1FM*	SD-1DM*	SD-1CB*	-
		7/32	1/4	6-3/4	SD-1L6SC	SD-1L6DC	SD-1L6FM	SD-1L6DM	SD-1L6CB	-
	5/16	1/4	1/4	2-1/16	SD-2SC	SD-2DC	SD-2FM	SD-2DM	SD-2CB	-
		5/16	1/4	2-1/8	SD-3SC	SD-3DC	SD-3FM	SD-3DM	SD-3CB	SD-3NX
	3/8	5/16	1/4	6-3/8	SD-3L6SC	SD-3L6DC	SD-3L6FM	SD-3L6DM	SD-3L6CB	-
		7/16	3/8	1/4	2-3/16	SD-4SC	SD-4DC	SD-4FM	SD-4DM	SD-4CB
	1/2	7/16	1/4	2-1/4	SD-5SC	SD-5DC	SD-5FM	SD-5DM	SD-5CB	SD-5NX
		7/16	1/4	6-1/2	SD-5L6SC	SD-5L6DC	SD-5L6FM	SD-5L6DM	SD-5L6CB	-
	5/8	9/16	1/4	2-3/8	SD-6SC	SD-6DC	SD-6FM	SD-6DM	SD-6CB	-
	3/4	11/16	1/4	2-1/2	SD-7SC	SD-7DC	SD-7FM	SD-7DM	SD-7CB	-
	1	15/16	1/4	2-3/4	SD-9SC	SD-9DC	SD-9FM	SD-9DM	SD-9CB	-

SE BURS - OVAL SHAPE

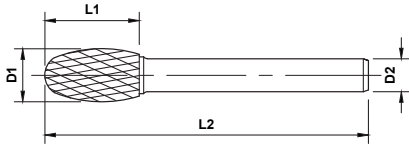

Standard, Singlecut, Series SE-SC



Standard, Doublecut, Series SE-DC



Standard, Alumacut, Series SE-FM



Long, Singlecut, Series SE-SC

Length Key (K)

Standard Long * Solid Carbide

Non-Ferrous **N** Alumacuts recommended for non-ferrous materials

Cast Iron **K** Titanium **S** Stainless **M** Steel **P** Hardened **H**

Quick Ship Items

K	OD	LOC	SHK	OAL	Cut Type					
	D1	L1	D2	L2	Singlecut	Doublecut	Alumacut	Diamondcut	Chipbreaker	NX Cut
*	1/8	7/32	1/8	1-1/2	SE-41SC	SE-41DC	SE-41FM	SE-41DM	SE-41CB	-
		3/8	1/8	1-3/4	SE-51SC	SE-51DC	SE-51FM	SE-51DM	SE-51CB	-
*	1/4	3/8	1/4	2	SE-1SC	SE-1DC	SE-1FM	SE-1DM	SE-1CB	-
		3/8	1/4	7	SE-1L6SC	SE-1L6DC	SE-1L6FM	SE-1L6DM	SE-1L6CB	-
	3/8	5/8	1/4	2-3/8	SE-3SC	SE-3DC	SE-3FM	SE-3DM	SE-3CB	SE-3NX
		5/8	1/4	6-5/8	SE-3L6SC	SE-3L6DC	SE-3L6FM	SE-3L6DM	SE-3L6CB	-
	1/2	7/8	1/4	2-5/8	SE-5SC	SE-5DC	SE-5FM	SE-5DM	SE-5CB	SE-5NX
		7/8	1/4	6-7/8	SE-5L6SC	SE-5L6DC	SE-5L6FM	SE-5L6DM	SE-5L6CB	-
	5/8	1	1/4	2-3/4	SE-6SC	SE-6DC	SE-6FM	SE-6DM	SE-6CB	-
		3/4	1	2-3/4	SE-7SC	SE-7DC	SE-7FM	SE-7DM	SE-7CB	-

SF BURS - RADIUS TREE SHAPE

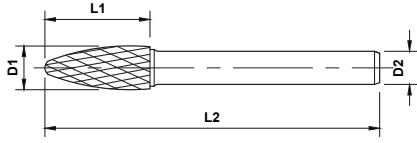

Standard, Singlecut, Series SF-SC



Standard, Doublecut, Series SF-DC



Standard, Alumacut, Series SF-FM



Long, Singlecut, Series SF-SC

Length Key (K)

Standard Long * Solid Carbide

Non-Ferrous **N** Alumacuts recommended for non-ferrous materials

Cast Iron **K** Titanium **S** Stainless **M** Steel **P** Hardened **H**

Quick Ship Items

K	OD	LOC	SHK	OAL	Cut Type					
					Singlecut	Doublecut	Alumacut	Diamondcut	Chipbreaker	NX Cut
*	1/8	1/4	1/8	1-1/2	SF-41SC	SF-41DC	SF-41FM	SF-41DM	SF-41CB	-
		1/2	1/8	1-1/2	SF-42SC	SF-42DC	SF-42FM	SF-42DM	SF-42CB	-
		1/2	1/4	2	SF-12SC	SF-12DC	SF-12FM	SF-12DM	SF-12CB	-
*	1/4	1/2	1/8	2	SF-51SC	SF-51DC	SF-51FM	SF-51DM	SF-51CB	-
		5/8	1/4	2	SF-1SC	SF-1DC	SF-1FM	SF-1DM	SF-1CB	-
		5/8	1/4	6-3/4	SF-1L6SC	SF-1L6DC	SF-1L6FM	SF-1L6DM	SF-1L6CB	-
	3/8	3/4	1/4	2-1/2	SF-3SC	SF-3DC	SF-3FM	SF-3DM	SF-3CB	SF-3NX
		3/4	1/4	6-3/4	SF-3L6SC	SF-3L6DC	SF-3L6FM	SF-3L6DM	SF-3L6CB	-
	7/16	1	1/4	2-3/4	SF-4SC	SF-4DC	SF-4FM	SF-4DM	SF-4CB	-
	1/2	3/4	1/4	2-1/2	SF-13SC	SF-13DC	SF-13FM	SF-13DM	SF-13CB	-
		1	1/4	2-3/4	SF-5SC	SF-5DC	SF-5FM	SF-5DM	SF-5CB	SF-5NX
		1	1/4	7	SF-5L6SC	SF-5L6DC	SF-5L6FM	SF-5L6DM	SF-5L6CB	-
	5/8	1	1/4	2-3/4	SF-6SC	SF-6DC	SF-6FM	SF-6DM	SF-6CB	-
	3/4	1	1/4	2-3/4	SF-7SC	SF-7DC	SF-7FM	SF-7DM	SF-7CB	-
		1-1/4	1/4	3	SF-14SC	SF-14DC	SF-14FM	SF-14DM	SF-14CB	-
		1-1/2	1/4	3-1/4	SF-15SC	SF-15DC	SF-15FM	SF-15DM	SF-15CB	-

Burs

SG BURS - POINTED TREE SHAPE

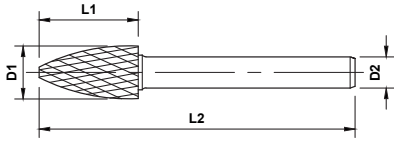

Standard, Singlecut, Series SG-SC



Standard, Doublecut, Series SG-DC



Standard, Alumacut, Series SG-FM



Long, Singlecut, Series SG-SC

Length Key (K)

Standard Long * Solid Carbide

Non-Ferrous **N** Alumacuts recommended for non-ferrous materials

Cast Iron **K** Titanium **S** Stainless **M** Steel **P** Hardened **H**

Quick Ship Items

K	OD	LOC	SHK	OAL	Cut Type					
	D1	L1	D2	L2	Singlecut	Doublecut	Alumacut	Diamondcut	Chipbreaker	NX Cut
*	1/8	1/4	1/8	1-1/2	SG-41SC	SG-41DC	SG-41FM	SG-41DM	SG-41CB	-
*		3/8	1/8	1-1/2	SG-43SC	SG-43DC	SG-43FM	SG-43DM	SG-43CB	-
*		1/2	1/8	1-1/2	SG-44SC	SG-44DC	SG-44FM	SG-44DM	SG-44CB	-
*	1/4	1/2	1/8	2	SG-51SC	SG-51DC	SG-51FM	SG-51DM	SG-51CB	-
		5/8	1/4	2	SG-1SC	SG-1DC	SG-1FM	SG-1DM	SG-1CB	-
	5/16	5/8	1/4	6-3/4	SG-1L6SC	SG-1L6DC	SG-1L6FM	SG-1L6DM	SG-1L6CB	-
		3/4	1/4	2-1/2	SG-2SC	SG-2DC	SG-2FM	SG-2DM	SG-2CB	-
	3/8	3/4	1/4	2-1/2	SG-3SC	SG-3DC	SG-3FM	SG-3DM	SG-3CB	SG-3NX
		3/4	1/4	6-3/4	SG-3L6SC	SG-3L6DC	SG-3L6FM	SG-3L6DM	SG-3L6CB	-
	1/2	3/4	1/4	2-1/2	SG-13SC	SG-13DC	SG-13FM	SG-13DM	SG-13CB	-
		1	1/4	2-3/4	SG-5SC	SG-5DC	SG-5FM	SG-5DM	SG-5CB	SG-5NX
		1	1/4	7	SG-5L6SC	SG-5L6DC	SG-5L6FM	SG-5L6DM	SG-5L6CB	-
	5/8	1	1/4	2-3/4	SG-6SC	SG-6DC	SG-6FM	SG-6DM	SG-6CB	-
		1	1/4	2-3/4	SG-7SC	SG-7DC	SG-7FM	SG-7DM	SG-7CB	-
	3/4	1	1/4	2-3/4	SG-7SC	SG-7DC	SG-7FM	SG-7DM	SG-7CB	-
		1-1/2	1/4	3-1/4	SG-15SC	SG-15DC	SG-15FM	SG-15DM	SG-15CB	-

SH BURS - FLAME SHAPE

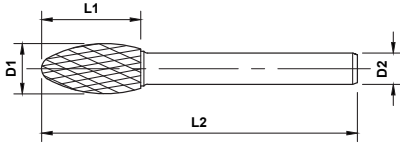

Standard, Singlecut, Series SH-SC



Standard, Doublecut, Series SH-DC



Standard, Alumacut, Series SH-FM



Long, Singlecut, Series SH-SC

Length Key (K)

Standard Long * Solid Carbide

Quick Ship Items

Non-Ferrous **N** Alumacuts recommended for non-ferrous materials

Cast Iron **K** Titanium **S** Stainless **M** Steel **P** Hardened **H**

K	OD	LOC	SHK	OAL	Cut Type					
					Singlecut	Doublecut	Alumacut	Diamondcut	Chipbreaker	NX Cut
*	1/8	1/4	1/8	1-1/2	SH-41SC	SH-41DC	SH-41FM	SH-41DM	SH-41CB	-
*	1/4	1/2	1/4	2	SH-1SC	SH-1DC	SH-1FM	SH-1DM	SH-1CB	-
		1/2	1/4	7	SH-1L6SC	SH-1L6DC	SH-1L6FM	SH-1L6DM	SH-1L6CB	-
	5/16	3/4	1/4	2-1/2	SH-2SC	SH-2DC	SH-2FM	SH-2DM	SH-2CB	SH-2NX
		3/4	1/4	6-3/4	SH-2L6SC	SH-2L6DC	SH-2L6FM	SH-2L6DM	SH-2L6CB	-
	1/2	1-1/4	1/4	3	SH-5SC	SH-5DC	SH-5FM	SH-5DM	SH-5CB	SH-5NX
		1-1/4	1/4	7-1/4	SH-5L6SC	SH-5L6DC	SH-5L6FM	SH-5L6DM	SH-5L6CB	-
	5/8	1-7/16	1/4	3-3/16	SH-6SC	SH-6DC	SH-6FM	SH-6DM	SH-6CB	-
	3/4	1-5/8	1/4	3-3/8	SH-7SC	SH-7DC	SH-7FM	SH-7DM	SH-7CB	-

SJ BURS - 60° INCLUDED CONE SHAPE

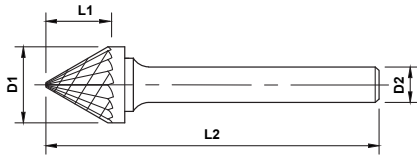

Standard, Singlecut Series SJ-SC



Standard, Doublecut Series SJ-DC



Standard, Alumacut Series SJ-FM

Non-Ferrous **N** Alumacuts recommended for non-ferrous materials

Cast Iron **K** Titanium **S** Stainless **M** Steel **P** Hardened **H**

Length Key (K)

Standard Long * Solid Carbide

K	OD	LOC	SHK	OAL	Cut Type				
					Singlecut	Doublecut	Alumacut	Diamondcut	Chipbreaker
*	1/8	3/32	1/8	1-1/2	SJ-42SC	SJ-42DC	SJ-42FM	SJ-42DM	SJ-42CB
		3/32	1/8	1-1/2	SJ-42DESC ^	SJ-42DEDC ^	SJ-42DEFM ^	SJ-42DEDM ^	SJ-42DECB ^
*	3/16	3/16	3/16	2	SJ-81SC	SJ-81DC	SJ-81FM	SJ-81DM	SJ-81CB
*	1/4	3/16	1/4	2	SJ-1SC	SJ-1DC	SJ-1FM	SJ-1DM	SJ-1CB
		3/16	1/4	2	SJ-1DESC ^	SJ-1DEDC ^	SJ-1DEFM ^	SJ-1DEDM ^	SJ-1DECB ^
*	5/16	5/16	1/4	2-1/16	SJ-2SC	SJ-2DC	SJ-2FM	SJ-2DM	SJ-2CB
*	3/8	5/16	1/4	2-1/16	SJ-3SC	SJ-3DC	SJ-3FM	SJ-3DM	SJ-3CB
*	1/2	7/16	1/4	2-3/16	SJ-5SC	SJ-5DC	SJ-5FM	SJ-5DM	SJ-5CB
*	5/8	9/16	1/4	2-5/16	SJ-6SC	SJ-6DC	SJ-6FM	SJ-6DM	SJ-6CB
*	3/4	11/16	1/4	2-7/16	SJ-7SC	SJ-7DC	SJ-7FM	SJ-7DM	SJ-7CB
*	1	15/16	1/4	2-9/16	SJ-9SC	SJ-9DC	SJ-9FM	SJ-9DM	SJ-9CB

^ Denotes Double End

SK BURS - 90° INCLUDED CONE SHAPE

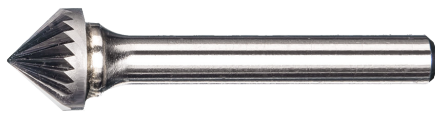
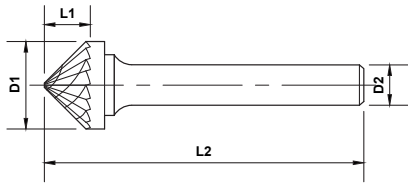

Standard, Singlecut SK-SC Series



Standard, Doublecut SK-DC Series



Standard, Alumacut SK-FM Series

Non-Ferrous **N** Alumacuts recommended for non-ferrous materials

Cast Iron **K** Titanium **S** Stainless **M** Steel **P** Hardened **H**

Length Key (K)

Standard Long * Solid Carbide

K	OD	LOC	SHK	OAL	Cut Type				
	D1	L1	D2	L2	Singlecut	Doublecut	Alumacut	Diamondcut	Chipbreaker
*	1/8	1/16	1/8	1-1/2	SK-42SC	SK-42DC	SK-42FM	SK-42DM	SK-42CB
		1/16	1/8	1-1/2	SK-42DESC ^	SK-42DEDC ^	SK-42DEFM ^	SK-42DEDM ^	SK-42DECB ^
*	1/4	1/8	1/4	2	SK-1SC	SK-1DC	SK-1FM	SK-1DM	SK-1CB
		1/8	1/4	2	SK-1DESC ^	SK-1DEDC ^	SK-1DEFM ^	SK-1DEDM ^	SK-1DECB ^
	5/16	3/16	1/4	1-15/16	SK-2SC	SK-2DC	SK-2FM	SK-2DM	SK-2CB
	3/8	3/16	1/4	2-1/16	SK-3SC	SK-3DC	SK-3FM	SK-3DM	SK-3CB
	7/16	1/4	1/4	2	SK-4SC	SK-4DC	SK-4FM	SK-4DM	SK-4CB
	1/2	1/4	1/4	2	SK-5SC	SK-5DC	SK-5FM	SK-5DM	SK-5CB
	5/8	5/16	1/4	2-1/16	SK-6SC	SK-6DC	SK-6FM	SK-6DM	SK-6CB
	3/4	3/8	1/4	2-1/8	SK-7SC	SK-7DC	SK-7FM	SK-7DM	SK-7CB
	1	1/2	1/4	2-1/4	SK-9SC	SK-9DC	SK-9FM	SK-9DM	SK-9CB

^ Denotes Double End

SL BURS - RADIUS CONE SHAPE

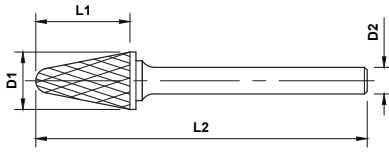

Standard, Singlecut, Series SL-SC



Standard, Doublecut, Series SL-DC



Standard, Alumacut SL-FM Series



Long, Singlecut, Series SL-SC

Length Key (K)

Standard Long * Solid Carbide

Non-Ferrous N	Alumacuts recommended for non-ferrous materials				
Cast Iron K	Titanium S	Stainless M	Steel P	Hardened H	

Quick Ship Items

K	OD	LOC	SHK	OAL	Angle	Cut Type						
						Inclusive	Singlecut	Doublecut	Alumacut	Diamondcut	Chipbreaker	NX Cut
*	1/8	3/8	1/8	1-1/2	8°		SL-41SC	SL-41DC	SL-41FM	SL-41DM	SL-41CB	-
		1/2	1/8	1-1/2	8°		SL-42SC	SL-42DC	SL-42FM	SL-42DM	SL-42CB	-
*	1/4	5/8	1/4	2	14°		SL-1SC	SL-1DC	SL-1FM	SL-1DM	SL-1CB	-
		5/8	1/4	6-3/4	14°		SL-1L6SC	SL-1L6DC	SL-1L6FM	SL-1L6DM	SL-1L6CB	-
	5/16	7/8	1/4	2-5/8	14°		SL-2SC	SL-2DC	SL-2FM	SL-2DM	SL-2CB	-
	3/8	1-1/16	1/4	2-13/16	14°		SL-3SC	SL-3DC	SL-3FM	SL-3DM	SL-3CB	SL-3NX
		1-1/16	1/4	7-1/16	14°		SL-3L6SC	SL-3L6DC	SL-3L6FM	SL-3L6DM	SL-3L6CB	-
	1/2	1-1/8	1/4	3-1/64	14°		SL-4SC	SL-4DC	SL-4FM	SL-4DM	SL-4CB	SL-4NX
		1-1/8	1/4	7-1/8	14°		SL-4L6SC	SL-4L6DC	SL-4L6FM	SL-4L6DM	SL-4L6CB	-
	5/8	1-3/16	1/4	2-15/16	14°		SL-5SC	SL-5DC	SL-5FM	SL-5DM	SL-5CB	-
		1-5/16	1/4	3-1/16	14°		SL-6SC	SL-6DC	SL-6FM	SL-6DM	SL-6CB	-
	3/4	1-1/2	1/4	3-1/4	14°		SL-7SC	SL-7DC	SL-7FM	SL-7DM	SL-7CB	-

SM BURS - POINTED CONE SHAPE

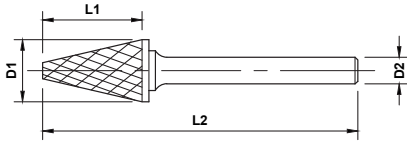

Standard, Singlecut, Series SM-SC



Standard, Doublecut, Series SM-DC



Standard, Alumacut, Series SM-FM



Long, Singlecut, Series SM-SC

Length Key (K)

Standard Long * Solid Carbide

Non-Ferrous N Alumacuts recommended for non-ferrous materials

Cast Iron K Titanium S Stainless M Steel P Hardened H

Quick Ship Items

K	OD	LOC	SHK	OAL	Angle	Cut Type				
	D1	L1	D2	L2	Inclusive	Singlecut	Doublecut	Alumacut	Diamondcut	Chipbreaker
*	1/8	11/32	1/8	1-1/2	12°	SM-41SC	SM-41DC	SM-41FM	SM-41DM	SM-41CB
		7/16	1/8	1-1/2	14°	SM-42SC	SM-42DC	SM-42FM	SM-42DM	SM-42CB
		5/8	1/8	1-1/2	7°	SM-43SC	SM-43DC	SM-43FM	SM-43DM	SM-43CB
*	1/4	1/2	1/8	2-1/8	22°	SM-51SC	SM-51DC	SM-51FM	SM-51DM	SM-51CB
		1/2	1/4	2	22°	SM-1SC	SM-1DC	SM-1FM	SM-1DM	SM-1CB
		1/2	1/4	6-3/4	14°	SM-1L6SC	SM-1L6DC	SM-1L6FM	SM-1L6DM	SM-1L6CB
		3/4	1/4	2	14°	SM-2SC	SM-2DC	SM-2FM	SM-2DM	SM-2CB
		3/4	1/4	6-3/4	14°	SM-2L6SC	SM-2L6DC	SM-2L6FM	SM-2L6DM	SM-2L6CB
		1	1/4	2	12°	SM-3SC	SM-3DC	SM-3FM	SM-3DM	SM-3CB
*	3/8	5/8	1/4	2-1/2	28°	SM-4SC	SM-4DC	SM-4FM	SM-4DM	SM-4CB
		5/8	1/4	6-5/8	28°	SM-4L6SC	SM-4L6DC	SM-4L6FM	SM-4L6DM	SM-4L6CB
*	1/2	7/8	1/4	2-3/4	28°	SM-5SC	SM-5DC	SM-5FM	SM-5DM	SM-5CB
		7/8	1/4	6-7/8	14°	SM-5L6SC	SM-5L6DC	SM-5L6FM	SM-5L6DM	SM-5L6CB
*	5/8	1	1/4	2-3/4	31°	SM-6SC	SM-6DC	SM-6FM	SM-6DM	SM-6CB

BURS

SN BURS - INVERTED CONE SHAPE

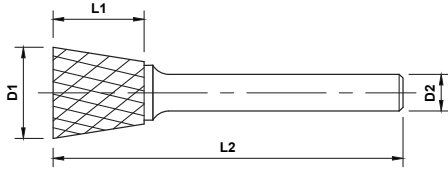

Standard, Singlecut, Series SN-SC



Standard, Doublecut, Series SN-DC



Standard, Alumacut, Series SN-FM



Long, Singlecut, Series SN-SC

Non-Ferrous **N** Alumacuts recommended for non-ferrous materials

Cast Iron **K** Titanium **S** Stainless **M** Steel **P** Hardened **H**

Length Key (K)

Standard Long * Solid Carbide

K	OD	LOC	SHK	OAL	Angle	Cut Type				
	D1	L1	D2	L2	Inclusive	Singlecut	Doublecut	Alumacut	Diamondcut	Chipbreaker
*	3/32	1/8	1/8	1-1/2	10°	SN-41SC	SN-41DC	SN-41FM	SN-41DM	SN-41CB
*	1/8	3/16	1/8	1-1/2	10°	SN-42SC	SN-42DC	SN-42FM	SN-42DM	SN-42CB
		1/4	1/8	1-3/4	10°	SN-51SC	SN-51DC	SN-51FM	SN-51DM	SN-51CB
*	1/4	5/16	1/4	2	10°	SN-1SC	SN-1DC	SN-1FM	SN-1DM	SN-1CB
		5/16	1/4	6-3/4	10°	SN-1L6SC	SN-1L6DC	SN-1L6FM	SN-1L6DM	SN-1L6CB
	3/8	3/8	1/4	2-1/8	15°	SN-2SC	SN-2DC	SN-2FM	SN-2DM	SN-2CB
		1/2	1/4	2-1/4	12°	SN-3SC	SN-3DC	SN-3FM	SN-3DM	SN-3CB
	1/2	1/2	1/4	2-1/4	28°	SN-4SC	SN-4DC	SN-4FM	SN-4DM	SN-4CB
		1/2	1/4	6-1/2	28°	SN-4L6SC	SN-4L6DC	SN-4L6FM	SN-4L6DM	SN-4L6CB
	5/8	5/8	1/4	2-3/8	18°	SN-5SC	SN-5DC	SN-5FM	SN-5DM	SN-5CB
		3/4	1/4	2-1/2	18°	SN-6SC	SN-6DC	SN-6FM	SN-6DM	SN-6CB
	3/4	5/8	1/4	2-3/8	30°	SN-7SC	SN-7DC	SN-7FM	SN-7DM	SN-7CB

DIE MILLS



Doublecut, Series 28000's

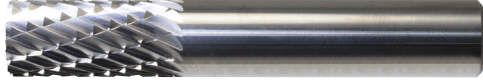

Coarse Doublecut, Series 28000's

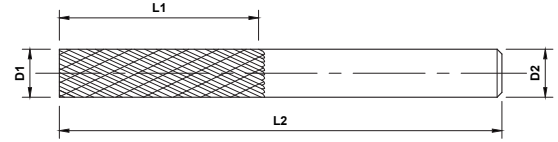

Length Key (K)

Standard Long * Solid Carbide



K	OD	LOC	SHK	OAL	Cut Type	
	D1	L1	D2	L2	Doublecut	Coarse Doublecut
	1/8	1/2	1/8	1-1/2	28000	28020
	5/32	1/2	3/16	2	28100	28120
	3/16	5/8	3/16	2	28200	28220
	1/4	3/4	1/4	2	28300	28320
	5/16	13/16	5/16	2-1/2	28400	28420
	3/8	1	3/8	2-1/2	28500	28520
	7/16	1	7/16	3	28600	28620
	1/2	1	1/2	3	28700	28720

PILOTED DIE MILLS



Doublecut, Series 22000's



Singlecut, Series 22000's

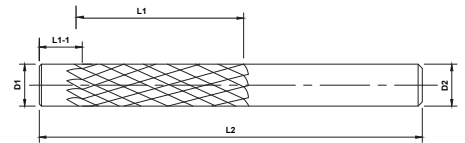

Length Key (K)

Standard Long * Solid Carbide



K	OD	LOC	Pilot	SHK	OAL	Cut Type	
	D1	L1	L1-1	D2	L2	Doublecut	Singlecut
	1/8	1	1/8	1/8	3	22000	22001
	3/16	2	3/16	3/16	3	22100	22101
	1/4	1-1/4	1/4	1/4	3	22200	22201
	3/8	2	3/8	3/8	4	22300	22301
	1/2	2	1/2	1/2	4	22400	22401

FIBERGLASS ROUTERS

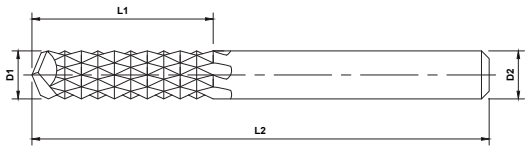

- High Performance A-Gr-SiV submicron grain carbide
- Diamond cut flute pattern
- Effective on laminate and fiberglass materials
- MAP certified quality



Standard, Plainend, Series FGR-A



Standard, Burend, Series FGR-B



Standard, Millend, Series FGR-C



Standard, Drillend, Series FGR-D

Length Key (K)

Standard Long * Solid Carbide

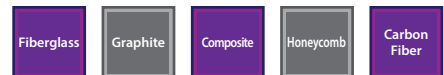

K	OD	LOC	SHK	OAL	End Cut Type			
	D1	L1	D2	L2	Plain (A)	Burend (B)	Millend (C)	Drillend (D)
*	1/16	3/16	1/8	1-1/2	FGR1A	FGR1B	FGR1C	FGR1D
*	3/32	3/8	1/8	1-1/2	FGR1-1A	FGR1-1B	FGR1-1C	FGR1-1D
*	1/8	1/2	1/8	1-1/2	FGR2A	FGR2B	FGR2C	FGR2D
*	3/16	5/8	3/16	2	FGR3A	FGR3B	FGR3C	FGR3D
*		5/8	1/4	2	FGR4A	FGR4B	FGR4C	FGR4D
*	1/4	3/4	1/4	2	FGR5A	FGR5B	FGR5C	FGR5D
*		3/4	1/4	2-1/2	FGR6A	FGR6B	FGR6C	FGR6D
*		1	1/4	2-1/2	FGR6-0A	FGR6-0B	FGR6-0C	FGR6-0D
*		3/4	1/4	3	FGR6-1A	FGR6-1B	FGR6-1C	FGR6-1D
*		1	1/4	3	FGR6-2A	FGR6-2B	FGR6-2C	FGR6-2D
*		5/16	1	5/16	2-1/2	FGR7A	FGR7B	FGR7C
*	3/8	1	3/8	2-1/2	FGR8A	FGR8B	FGR8C	FGR8D
*	1/2	1	1/2	3	FGR9A	FGR9B	FGR9C	FGR9D

TIRE BURS

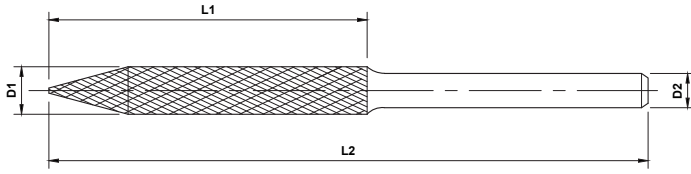

- High Performance A-Gr-SiV submicron grain carbide
- Solid carbide construction
- Superb for trimming and repairing steel belted tire
- MAP certified quality

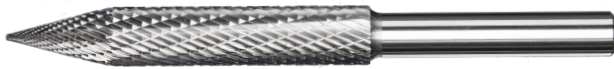

Standard, Round-Shank, Series STB-

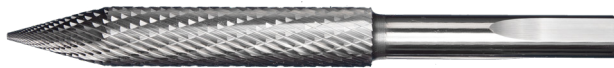

Standard, Tri-Shank, Series STB-T

Length Key (K)

 Standard
 Long
 * Solid Carbide

Steel
P

	OD	LOC	SHK	OAL	Shank Type	
K	D1	L1	D2	L2	Round Shank	Tri-Shank
*	3/16	1	3/16	2	STB-011	STB-011T
*		2	3/16	3	STB-012	STB-012T
*	7/32	2	1/4	3	STB-013	STB-013T
*	1/4	2	1/4	3	STB-014	STB-014T
*	5/16	1-1/2	5/16	3	STB-015	STB-015T
*		2	5/16	4	STB-016	STB-016T
*	3/8	3	3/8	4-1/2	STB-017	STB-017T
*	1/2	3	3/8	5	STB-018	STB-018T

PLASTIC BUR BOX SETS



Non-Ferrous
N
Alumacut
recommended
for non-ferrous
materials

Empty Cases	Empty Case Part ID
12 Piece Bur Set, Plastic Case 1/8" Holes	PLASTIC-SET1
12 Piece Bur Set, Plastic Case 1/4" Holes	PLASTIC-SET2

Plastic Box Bur Set						
Pieces	Burs Included	Shank Diameter	Singlecut	Doublecut	Diamond Cut	Alumacut
12	SA-43, SA-42, SC-42, SC-41, SD-42, SE-41, SF-41, SG-41, SH-41, SJ-42, SL-42, SN-42	1/8"	SETM100PSC	SETM100PDC	SETM100PDM	—
12	SA-1, SA-14, SC-1, SC-14, SD-1, SE-1, SF-1, SG-1, SH-1, SJ-1, SM-1, SN-1	1/4"	SETM120PSC	SETM120PDC	SETM120PDM	—
9	SA-51, SB-51, SC-51, SD-51, SE-51, SF-51, SG-51, SM-51, SN-51	1/8"	SETM110PSC	SETM110PDC	SETM110PDM	SETM110PFM
8	SA-1, SA-3, SC-1, SC-3, SD-1, SD-3, SF-1, SF-3	1/4"	SETM130PSC	SETM130PDC	SETM130PDM	SETM130PFM
8	SB-1, SB-3, SC-1, SC-3, SD-1, SD-3, SF-1, SF-3	1/4"	SETM135PSC	SETM135PDC	SETM135PDM	SETM135PFM
8	SA-3, SA-5, SC-3, SC-5, SD-3, SD-5, SF-3, SF-5	1/4"	SETM140PSC	SETM140PDC	SETM140PDM	SETM140PFM
8	SB-3, SB-5, SC-3, SC-5, SD-3, SD-5, SF-3, SF-5	1/4"	SETM145PSC	SETM145PDC	SETM145PDM	SETM145PFM
8	SA-5, SC-3, SC-5, SD-5, SF-3, SF-5, SG-3, SL-4	1/4"	SETM150PSC	SETM150PDC	SETM150PDM	SETM150PFM
8	SB-5, SC-3, SC-5, SD-5, SF-3, SF-5, SG3-, SL-4	1/4"	SETM155PSC	SETM155PDC	SETM155PDM	SETM155PFM



POWER POUCH BUR SETS

Power Pouch Bur Sets		
Part ID	Shank Diameter	Description
POUCH-NL	1/4"	Blue Nylon Pouch with Snap for Bur Sets (up to 5 Burs) 4" x 6" No Logo
POUCH-WL	1/4"	Blue Nylon Pouch with Snap for Bur Sets (up to 5 Burs) 4" x 6" White Screen Printed Logo
POUCH-NL1DC	1/4"	SF-5, SF-3, SF-1 3pc. Doublecut Set in Blue Wallet Pouch Without Logo
POUCH-NL1FM	1/4"	SF-5, SF-3, SF-1 3pc. Alumacut Set in Blue Wallet Pouch Without Logo
POUCH-NL2DC	1/4"	SC-5, SC-3, SF-5, SF-3 4pc. Doublecut Set in Blue Wallet Pouch Without Logo
POUCH-NL2FM	1/4"	SC-5, SC-3, SF-5, SF-3 4pc. Alumacut Set in Blue Wallet Pouch Without Logo
POUCH-NL3DC	1/4"	SA-1, SC-3, SF-3, SC-5, SF-5 5pc. Doublecut Set in Blue Wallet Pouch Without Logo
POUCH-NL3FM	1/4"	SA-1, SC-3, SF-3, SC-5, SF-5 5pc. Alumacut Set in Blue Wallet Pouch Without Logo
POUCH-WL1DC	1/4"	SF-5, SF-3, SF-1 3pc. Doublecut Set in Blue Wallet Pouch With Mastercut Logo
POUCH-WL1FM	1/4"	SF-5, SF-3, SF-1 3pc. Alumacut Set in Blue Wallet Pouch With Mastercut Logo
POUCH-WL2DC	1/4"	SC-5, SC-3, SF-5, SF-3 4pc. Doublecut Set in Blue Wallet Pouch With Mastercut Logo
POUCH-WL2FM	1/4"	SC-5, SC-3, SF-5, SF-3 4pc. Alumacut Set in Blue Wallet Pouch With Mastercut Logo
POUCH-WL3DC	1/4"	SA-1, SC-3, SF-3, SC-5, SF-5 5pc. Doublecut Set in Blue Wallet Pouch With Mastercut Logo
POUCH-WL3FM	1/4"	SA-1, SC-3, SF-3, SC-5, SF-5 5pc. Alumacut Set in Blue Wallet Pouch With Mastercut Logo

24 PIECE COUNTERTOP DISPLAY



Description	Burs Included	Shank Diameter	Part Number
24 Piece Bur Display Doublecut	SA-1, SC-1, SD-1, SE-1, SF-1, SG-1, SL-1, SM-3, SA-3, SC-3, SD-3, SE-3, SF-3, SG-3, SL-3, SM-4, SA-5, SC-5, SD-5, SE-5, SF-5, SG-5, SL-4, SM-5 (ALL BURS DOUBLECUT)	1/4"	DISPLAY2
24 Piece Bur Set Without Plastic Display	Same as Above	1/4"	DIS24-ND

TECHNICAL INFORMATION

- **ISO**
- **MAP**
- **CNC 1st**
- **Coatings**
- **Trouble Shooting Guide**
- **Speeds and Feeds**

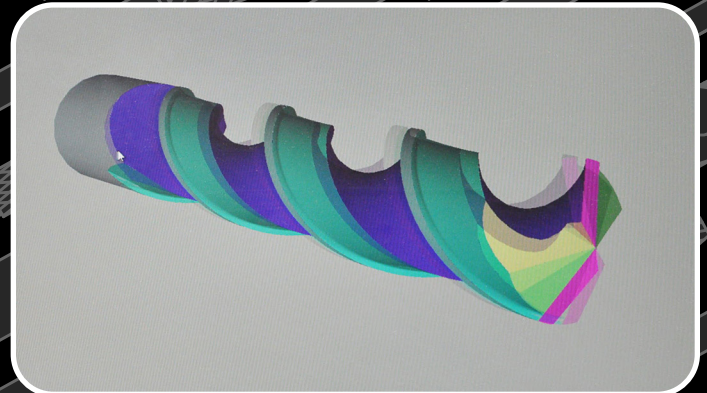
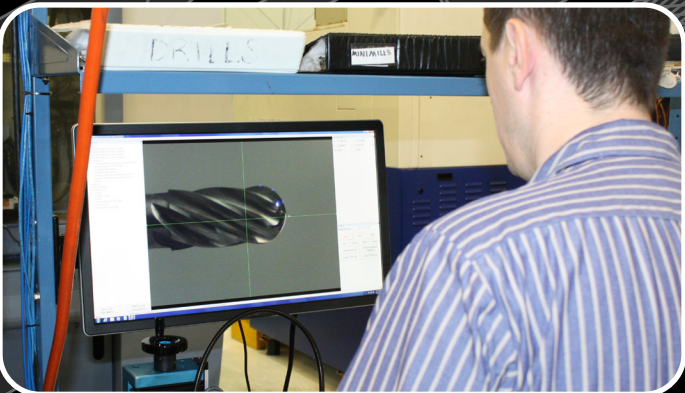
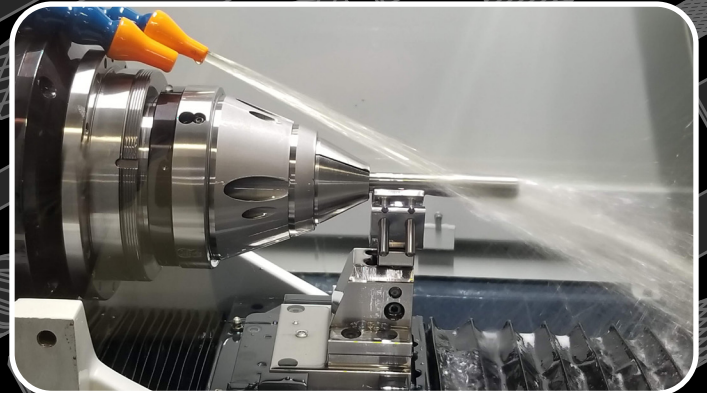
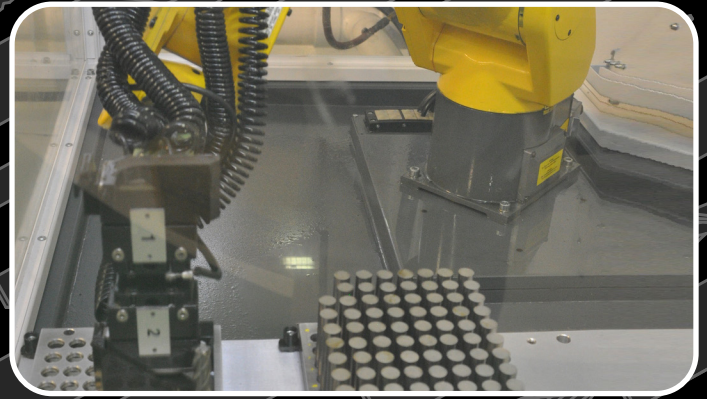
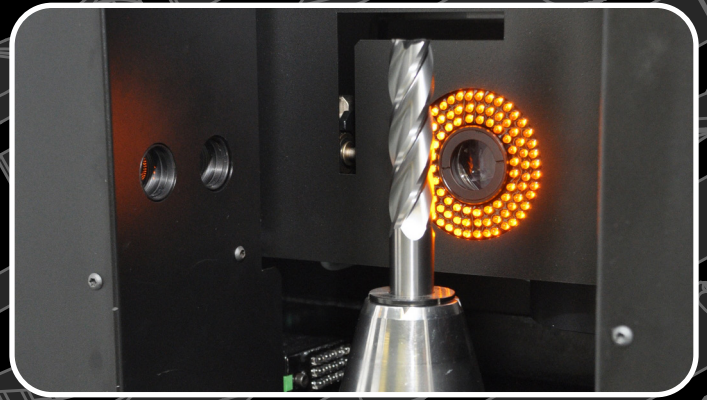

QUALITY PROCESSES

YOUR PREMIER SOURCE FOR THE HIGHEST QUALITY CUTTING TOOLS FOR MORE THAN A QUARTER CENTURY!

From 1985 to the present, the values and ideals of Mastercut Tool Corp. remain steady. We will work relentlessly to continuously improve and provide you with excellence. We are known worldwide for many unique high performance tools engineered in our Florida facilities. Our AxMill, V4, V5, and F45 are just a few products that make Mastercut Tool Corp. your choice for increasing production and reducing costs.

ISO 9001:2015

In 2003, Mastercut Tool Corp. successfully achieved registration under ISO 9001:2000 and has maintained our quality system to our current ISO 9001:2015 certification and Lean Six Sigma practices. We maintain these strict standards to further guarantee that every tool you buy from Mastercut Tool Corp. is of the highest quality.



The “MAP” to Your Success!

Our continuous improvement has led us to a process that gives you unmatched, consistent quality. That process is our unique MAP Technology! Mastercut Automated Production is our exclusive method of standardization and quality repeatability. The MAP combines technology, skill, and rigid processes to provide you with the most precise products that money can buy, batch to batch and year to year.



Our MAP...your map to success!

CNC 1st Team



Customers' Needs Come First! This is what truly matters to us. To ensure you the fastest possible service, we have assembled simulation, engineering, production scheduling, customer service, and inventory personnel into one unit. They collaborate on any and all special requests from you, the moment your request is received. They are dedicated and qualified to assist you with solutions, fast!

Mastercut's Superior Carbide Blend – A-Gr-SiV (Active Grain Sized-Volume)

Our superior tungsten carbide gives you the ability to be aggressive when you need to be. Growth inhibitors in our submicron carbide blanks maintain the most consistent grain size available, giving you superior hardness AND toughness.

SUCCESS

At Mastercut Tool, we take great pride in our high quality control standards and in the accomplishments of your customers using our superior quality tools. Therefore, our bottom line is:

Your customers' success with our products is the measure of our success!

MASTERCUT TOOL COATING OPTIONS

Mastercut Premier Coatings

- Speed and Feed increases from 30 to 200 percent
- Tool life is increased up to 10 times
- Reduces friction, spindle torque and vibration, providing a better finish
- Isolates the tool from the part, avoids edge buildup and tool cratering
- Reduces or eliminates coolant
- Repeatable, stable performance between batches

Preferred Coating Use

Materials	PowerT	PowerC	PowerA	PowerZ	PowerN	PowerNR	PowerDLC	PowerRD
Aluminum, Low Silicon < 10%				✓			✓	✓
Aluminum, High Silicon > 10%		✓		✓			✓	✓
Copper, Copper Alloys	✓		✓	✓			✓	
Ductile, Malleable Cast Iron	✓	✓	✓		✓	✓		
Carbon Steel, 1000 Series	✓	✓	✓		✓	✓		
Alloy Steel, 4 to 9000 Series	✓	✓	✓		✓	✓		
Tool Steel	✓	✓	✓		✓	✓		
SS Steel, 300 Series	✓	✓	✓	✓	✓	✓		
SS Steel, 400 Series	✓	✓	✓	✓	✓	✓		
SS PH Series	✓	✓	✓	✓	✓	✓		
Titanium, Titanium Alloys	✓	✓	✓	✓	✓	✓		
Nickel, Nickel Alloys, Cobalt	✓		✓		✓	✓		
Wood, Paper			✓	✓			✓	
Composites, Plastics	✓		✓	✓	✓		✓	✓
Graphite							✓	✓
Fiberglass		✓	✓	✓			✓	✓

MASTERCUT TOOL COATING OPTIONS



PowerT (Titanium Nitride, TiN) (append -2)*

Color: Gold
Vickers Hardness: approximately 2,300 Vickers
General purpose, entry level over uncoated carbide



PowerC (Titanium Carbon Nitride, TiCN) (append -3)*

Color: ranges from slight violet to brown-gray
Vickers Hardness: approximately 3,000 Vickers
Used on ferrous, non-ferrous and non-magnetic stainless steel
Good abrasion resistance, low heat resistance, for applications requiring low RPMs and high thrust



PowerA (Aluminum Titanium Nitride, AlTiN) (append -1)*

Color: Dark Gray
Vickers Hardness: approximately 3,600 Vickers
Nickel Alloys, Stainless Steel, Hardened Steels, Tool Steels, Cast Iron
An excellent broad spectrum grade. May be run in dry or minimum quantity lubrication applications, where heat can be a problem. Also handles light chip loads very well



PowerZ (Zirconium Nitride, ZrN) (append -4)*

Color: Dull Gold
Vickers Hardness: approximately 2,800 Vickers
Outstanding on aluminum, including high silica aluminum. Can also be used on cast iron, stainless steels, titanium

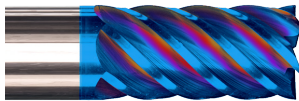

PowerN (nACo) nano-composite (nc-AlTiN)/(a-Si³N⁴) (append -5)*

Color: Varying hues of blue and red
Vickers Hardness: approximately 4,500 Vickers
Outstanding performance in superalloys, hard material machining, and high heat applications.



PowerNR (nACRo) nano-composite (nc-AlCrN/a-Si³N⁴)(append -8)*

Color: gray
Vickers Hardness: approximately 4,000 Vickers
Outstanding in high heat applications, better resistance to shock and chipping than nACo, for tough, aggressive cutting applications.



PowerDLC (Diamond Like Carbon)(append -6)*

Color: variable gray to black
Vickers Hardness: approximately 4,000 Vickers
Non-ferrous metals, high silicone aluminum, copper, plastic, graphite, fiberglass or reinforced plastics
Can be applied to any carbide substrate



PowerRD (Real Diamond)(append -7)*

Color: variable gray to black
Vickers Hardness: approximately 8,000 Vickers
Non-ferrous, metals, aluminum, graphite, green ceramics, and composites
Requires 6% cobalt carbide for application

* *append -#* indicates that this coating is applied to uncoated tool part number

MASTERCUT TROUBLESHOOTING GUIDES

Solid Carbide Endmills		
Challenge	Cause	Corrective Action
Chattering	Incorrect Feed Rate	Reduce feed rate 10%
	Incorrect Speed	Check recommendations, adjust accordingly
	Low Tool Holder Rigidity	Replace tool holder with more rigid tool holder
	Low Machine Tool Spindle Rigidity	Utilize machine with larger spindle
	Relief Angle Too Steep	Switch to tool with less relief or regrind tool to reduce angle
	Low Work Piece Rigidity	Tighten or improve work piece holding method
	Depth of Cut	Reduce depth of cut
	Incorrect Tool Cut Length	Use shorter flute length and/or place tool shank deeper in tool holder
	Bad Collet	Replace collet
	Tool Too Sharp	Reduce feed rate 10% for initial cut to break in tool
Breakage	Incorrect Feed Rate	Reduce feed rate
	Incorrect Depth of Cut	Reduce depth of cut
	Incorrect Tool Cut Length	Use shorter flute length - Place tool shank deeper in tool holder
	Incorrect Tool Overall Length	Use shorter tool or place tool shank deeper in tool holder
	Tool Wear	Replace tool or sharpen tool at earlier stage
	Chip Impaction	Increase coolant flow
Chipping	Incorrect Feed Rate	Reduce feed rate
	Improper Tool Break In	Reduce feed rate 10% for initial cut to break in tool
	Incorrect Feed Direction	Change cut path to climb milling
	Chatter	See recommendations for correcting chatter
	Low Tool Holder Rigidity	Replace tool holder with higher rigidity tool holder
	Low Machine Tool Spindle Rigidity	Utilize machine with larger spindle
	Low Work Piece Rigidity	Tighten or improve work piece holding method
	Tool Too Sharp	Reduce feed rate 10% for initial cut to break in tool
	Loose Tool Holder	Clean and tighten tool holder
	Loose End Mill	Tighten tool holder
	Incorrect Speed	Check recommendations and adjust accordingly
	Lack of Hone	Hone Cutting edge

MASTERCUT TROUBLESHOOTING GUIDES

Solid Carbide Endmills		
Challenge	Cause	Corrective Action
Wear	Incorrect Speed	Check recommendations and adjust accordingly
	Incorrect Feed Rate	Reduce or increase feed rate
	Incorrect Feed Direction	Change cut path to climb milling
	Hard Material	Use tool designed for hard material - Use coated tools
	Chip Impaction	Increase coolant volume - Increase coolant pressure
	Poor Coolant Condition	Replace coolant or correct mix ratio
	Short Tool Life	Use tool designed for work piece material - Use coated tools
	Incorrect Tool Geometry	Utilize tool recommended for work piece material
Chip Impaction	Incorrect Feed Rate	Reduce feed rate
	Incorrect Speed	Check recommendations and adjust accordingly
	Incorrect Tool Geometry	Utilize tool recommended for work piece material
	Insufficient Coolant	Increase coolant volume - Increase coolant pressure
Poor Surface Finish	Incorrect Feed Rate	Reduce feed rate
	Incorrect Speed	Check recommendations and adjust accordingly
	Tool Wear	Replace tool or sharpen tool at earlier stage
	Incorrect Depth of Cut	Reduce depth of cut
	Chip Impaction	Increase coolant volume - Increase coolant pressure
	End Cut Smearing	Grind tool with wiper flat
	Incorrect Tool Geometry	Utilize tool recommended for work piece material
Burring	Tool Wear	Replace tool or sharpen tool at earlier stage
	Incorrect Feed Direction	Change cut path to climb milling
	Incorrect Speed	Check recommendations and adjust accordingly
	Incorrect Feed Rate	Reduce feed rate
	Incorrect Depth of Cut	Reduce depth of cut
	Incorrect Tool Geometry	Utilize tool recommended for work piece material
Dimensional Inaccuracy	Tool Deflection	Reduce tool length of cut - Place tool deeper in tool holder
	Incorrect Tool Geometry	Utilize tool recommended for work piece material
	Low Tool Holder Rigidity	Replace tool holder with more rigid tool holder
	Low Machine Tool Spindle Rigidity	Utilize machine with larger spindle - Tighten tool holder
	Low Work Piece Rigidity	Tighten or improve work piece holding method
	Bad Collet	Replace collet
	Machine Tool/Work Piece Set Up	Check for proper angular set up

MASTERCUT TROUBLESHOOTING GUIDES

Solid Carbide Drills		
Challenge	Cause	Corrective Action
Drill Point Chipping	Incorrect Feed Rate	Lower feed rate
	Incorrect Speed Rate	Check speed recommendations, adjust accordingly
	Incorrect Tool Cut Length	Use shorter tool - place tool shank deeper in tool holder
	Low Work Piece Rigidity	Tighten or improve work piece holding method
	Loose Tool	Tighten or replace tool holding method
	Poor Coolant Conditions	Replace coolant or correct mix ratio
Chisel/Point Center Breakage	Incorrect Initial Feed Rate	Lower initial feed rate 30%
	Poor Work Piece Surface Condition	Grind or clean work piece surface
	Drill Point Off Center	Re-point drill, check set up in tool holder
	Insufficient Drill (web) Thinning	Re-point and thin drill point
Breakage/Chipping at Outer Cutting Edge	Incorrect Feed Rate	Lower feed rate
	Incorrect Speed Rate	Check speed recommendations, adjust accordingly
	Low Work Piece Rigidity	Tighten or improve work piece holding method
	Low Tool Holding Strength	Tighten tool holder or use end mill holder
	Poor Tool Set Up - Concentricity	Minimize runout to less than .001"
	Poor Coolant Conditions	Replace coolant or correct mix ratio
	Incorrect Tool Cut Length	Use shorter tool - place tool shank deeper in tool holder
Tool Wear Life	Incorrect Speed Rate	Check speed recommendations, adjust accordingly
	Poor Coolant Conditions	Replace coolant or correct mix ratio
	Improper Drill Point	Re-point drill or use recommended drill point for material
	Abrasive/Tough Work Piece Material	Use coated tool (Check recommendations for coating)
Tool Breakage	Inconsistent Feed Rate	Maintain constant feed rate
	Incorrect Feed Rate	Lower feed rate
	Poor Tool Set Up - Concentricity	Minimize runout to less than .001"
	Low Tool Holding Strength	Tighten tool holder or use end mill holder
	Incorrect Tool	Check recommendations for proper drill and drill point
	Poor Coolant Conditions	Replace coolant or correct mix ratio
	Low Work Piece Rigidity	Tighten or improve work piece holding method
Outside Margin Damage / Wear	Poor Tool Set Up - Concentricity	Minimize runout to less than .001"
	Incorrect Tool Selection	Use recommended drill/drill point for work piece material
	Poor Coolant Conditions	Replace coolant or correct mix ratio
	Insufficient Coolant	Increase coolant volume - Increase coolant pressure
	Chip Packing	Increase coolant volume - Increase coolant pressure

MASTERCUT TROUBLESHOOTING GUIDES

Solid Carbide Drills		
Challenge	Cause	Corrective Action
Outside Margin Damage / Wear (cont.)	Low Work Piece Rigidity	Tighten or improve work piece holding method
	Loose Tool	Tighten or replace tool holding method
	Incorrect Feed Rate	Lower feed rate
	Incorrect Speed Rate	Check speed recommendations adjust accordingly
Chip Impaction	Incorrect Speed Rate	Typically increase speed, check speed recommendations
	Incorrect Feed Rate	Typically increase feed recommendations
	Poor Coolant Conditions	Replace coolant or correct mix ratio
	Insufficient Coolant	Increase coolant volume - Increase coolant pressure
	Incorrect Tool	Check recommendations for proper drill and drill point
Long/Stringy Chips	Incorrect Feed Rate	Typically increase feed, check feed recommendations
	Incorrect Point Angle	Regrind Point to recommended angle, Replace drill
	Edge Sharpness	Hone cutting edge, use pre-honed drill
	Inconsistent Feed Rate	Maintain constant feed rate - Peck Drill to change feed rate
Poor Surface Finish	Incorrect Speed Rate	Typically increase speed, check speed recommendations
	Incorrect Feed Rate	Lower feed rate
	Poor Coolant Conditions	Replace coolant or correct mix ratio
	Tool Wear	Regrind or Replace drill
Hole Accuracy	Edge Sharpness	Hone cutting edge, use pre-honed drill
	Incorrect Tool	Check recommendations for proper drill and drill point
	Edge Sharpness	Hone cutting edge, use pre-honed drill
	Incorrect Tool Cut Length	Use shorter tool - place tool shank deeper in tool holder
	Tool Size Accuracy	Replace tool
Tool Deflection	Poor Work Piece Surface Condition	Grind or clean work piece surface
	Incorrect Tool Cut Length	Use shorter tool - place tool shank deeper in tool holder
	Uneven Drill Point	Regrind drill point
	Incorrect Point Angle	Regrind Point to recommended angle, Replace drill
	Uneven Work Surface	Use self centering drill point or spot drill
Vibration/Noise	Edge Sharpness	Hone cutting edge, use pre-honed drill
	Incorrect Tool Cut Length	Use shorter tool - place tool shank deeper in tool holder
	Incorrect Point Angle	Regrind Point to recommended angle, Replace drill
	Inconsistent Feed Rate	Maintain constant feed rate - Peck Drill to change feed rate
	Incorrect Speed Rate	Check speed recommendations adjust accordingly
	Low Tool Holding Strength	Tighten tool holder or use end mill holder

MASTERCUT TROUBLESHOOTING GUIDES

Solid Carbide Reamers		
Challenge	Cause	Corrective Action
Hole Accuracy	Misaligned Starter Hole	Inspect fixturing/work piece set up - Use floating tool holder or bushing
	Incorrect Speed Rate	Typically increase speed, check speed recommendations
	Incorrect Feed Rate	Typically decrease feed, check feed recommendations
	Incorrect Tool Diameter	Inspect tool diameter. Replace or reduce diameter
	Tool Wear	Sharpen or replace tool - Use coated tool
Poor Finish	Unequal Cutting Edges	Regrind tool with equal chamfer height or radius size
	Incorrect Feed Rate	Check feed recommendations, adjust accordingly
	Incorrect Speed Rate	Check speed recommendations, adjust accordingly
	Chatter	Increase speed rate or decrease feed rate
	Insufficient Material Removal	Reduce initial drill size - Leave 2-3% of finished size for reaming
	Spindle/Tool Holder Runout	Use bushing. Replace tool holder (Bushing to be .0003" larger than reamer)
	Damaged Tool	Regrind or replace tool
	Insufficient Cutting Clearance	Reduce clearance behind chamfer or radius
Angled Holes	Inconsistent Feed Rate	Maintain constant feed. Use power feed on manual machines
	Drill Deflection/Walk	Correct drilling operation (Check drill trouble shooting for corrective actions)
	Insufficient Material Removal	Reduce initial drill size. Leave 2-3% of finished size for reaming
	Misaligned Set Up	Inspect fixturing/work piece set up - Use floating tool holder or bushing
Premature Tool Wear	Insufficient Chamfer Angle	Regrind reamer with higher included angle (100° - 180°)
	Incorrect Material Removal	Drill initial hole size to leave 2-3% of finished size for reaming
	Incorrect Feed Rate	Typically decrease feed, check feed recommendations
	Misaligned Starter Hole	Inspect fixturing/work piece set up. Use floating tool holder or bushing
	Hard or Abrasive Material	Use coated tool
	Poor Coolant Condition	Replace coolant or correct mix ratio
Chatter	Chip evacuation	Increase coolant flow
	Incorrect Speed Rate	Typically increase speed, check speed recommendations
	Incorrect Feed Rate	Typically decrease feed, check feed recommendations
	Loose Tool	Tighten or replace tool holding method
	Low Work Piece Rigidity	Tighten or improve work piece holding method
	Low Tool Holding Strength	Tighten tool holder. Minimize float
	Poor Tool Set Up - Concentricity	Minimize runout to less than .0002"
Low Tool Rigidity	Use shorter reamer - Place tool shank deeper in tool holder	
Tool Breakage	Misaligned Set Up	Inspect fixturing/work piece set up. Use floating tool holder or bushing
	Drill Deflection/Walk	Correct drilling operation (Check drill trouble shooting for corrective actions)
	Tool Wear	Sharpen or replace tool - Use coated tool
	Damaged Tool	Regrind or replace tool
	Incorrect Material Removal	Check initial drill size - Leave 2-3% of finished size for reaming
	Incorrect Speed Rate	Typically decrease speed, check speed recommendations
	Incorrect Feed Rate	Typically increase feed, check feed recommendations
	Tool Bottoming in Hole	Reduce depth of cut - adjust stop depth

MASTERCUT TROUBLESHOOTING GUIDES

Carbide Burs - Possible Causes and Solutions

Challenge	Excessive Force	Heat From Rubbing Shank	Dull Flutes	Seized In/Against Workpiece	Tool Dropped	Poor Location in Collet	Worn Handpiece Bearings	Bent Shank	Poor Working Stability	Use Coarser Geometry	Use Finer Geometry	Use Double Cut or Chip Breaker Geometry	Soft Material - Lighten Feed	Increase RPMs	Decrease RPMs	Avoid Diamond Cut	Use Anti-stick compound	Faster Feed Rate	Slower Feed	Abrasive Material	Poor Set-Up	Failure To Support / Engage Prior to RPM
Braze Failure	X	X	X	X	X																	
Poor Hand Control						X	X	X	X		X	X									X	
Chipping				X	X				X				X									
Carbide Fracture				X	X				X													
Plugging										X		X				X						
Handpiece Vibration													X	X			X	X		X		
Poor Workpiece Finish						X	X	X	X		X		X	X			X			X		
Poor Tool Life		X	X			X	X	X	X				X	X	X		X	X	X	X		
Lack of Available Handpiece RPMs											X	X										
Work Hardening of Workpiece	X		X							X	X		X					X				
Severely Bent Shanks of Long Series Burs																				X	X	

TECHNICAL INFORMATION MATERIAL GROUPINGS











Material Group	Material Type	Hardness	USA Standards, SAE/AISI/UNS
Steel			
1.1	Magnetic soft steel	< 120 B	12L14, 12L15
1.2	Structural, case carburising	< 200 B	1005-1025, 1214, 1215, A36
1.3	Plain carbon steel	< 250 B	1030-1060, 1144-1146
1.4	Alloy Steel	< 250 B	4140, 4340, 52100,8620, H11-H41, A2, D2, O1, P20, 420
1.5	Alloy steel, hardened/tempered steel	350	4140, 4340, 52100,8620, H11-H41, A2, D2, O1, P20, 420
1.6	Alloy steel, hardened/tempered steel	> 350 B	4140, 4340, 52100,8620, H11-H41, A2, D2, O1, P20, 420
1.7	Alloy steel, hardened	49-55 C	A2, H10-H41, L1-L6, M1-M42, T1
1.8	Alloy steel, hardened	55-60 C	A2, H10-H41, L1-L6, M1-M42, T1
1.9	Alloy steel, hardened	>60C	A2, H10-H41, L1-L6, M1-M42, T1
Stainless Steel			
2.1	Free Machining Stainless	< 250 B	200, 303, 416, 420F, 430F,440
2.2	Austenetic	< 250 B	301,302,304,316,321,330,AM-350, Custom 455
2.3	Ferritic + Austenetic, Martensitic	< 300 B	318-329, 400-446, 15-4PH,17-4PH,Duplex
2.4	Precipitation Hardened	< 300 B	15-5PH, 17-4PH, Custom 450
Cast Iron			
3.1	Lamellar graphite	< 150	Grey, G10, Gg40, J431C, A48 Class 20
3.2	Lamellar graphite	>150<300	Grey, GG25-Gg40, J158, A48 Class 40-60
3.3	Nodular graphite, malleable cast iron	< 200	A220, A436, A439, A602, Black, GGG40-GGG70
3.4	Nodular graphite, malleable cast iron	>200<300	Black Gts/Gtw, J434C
Titanium			
4.1	Unalloyed	< 200	Commercially Pure
4.2	Alloyed	< 270	6A14V,6A14V-2Sn, Monel, Monel K
4.3	Alloyed	>270<350	6A14V-4Mo,7A14-V-4Mo, 4911-4967
Nickel			
5.1	Unalloyed	< 150	Commercially Pure
5.2	Alloyed	< 270	Monel 400, Hastelloy C, Inconel 625, Waspaloy
5.3	Alloyed	>270<350	Inconel 718, Nimonic 75-95, Rene 41,Inconel 825, A286
Copper			
6.1	Copper	< 100	Commercially Pure
6.2	β Brass, Bronze	< 200	314-340, 350-370
6.3	γ-Brass	< 200	Alloyed Cu + Al + Fe, Long Chipping
6.4	High Strength Bronze	< 470	Ampco 18-25
Aluminum, Magnesium			
7.1	Al,Mg, unalloyed	< 100	Commercially Pure
7.2	Al alloyed, Si<0.5%	< 150	6061 T6, 7075, 314-340
7.3	Al alloyed, Si>0.5%<10%	< 120	6061 T6, 380-390
7.4	Al alloyed, Si>10%	< 120	Magnesium Whisker Reinforced
Synthetic Materials			
8.1	Thermoplastics	n/a	Ultramid, Polystrol
8.2	Thermosetting plastics	n/a	Bakelite, Pertinax
8.3	Reinforced plastic materials	n/a	CFK, GFKAFK
Hard Materials			
9.1	Cermets (Metal-ceramics)	< 550	

TECHNICAL INFORMATION











Suggested Endmill Starting Feed Per Tooth

Cutting Diameter	1/32"	1/16"	1/8"	5/32"	3/16"	1/4"	5/16"	3/8"	1/2"	5/8"	3/4"	1"
Material Group												
1.1	0.0002	0.0004	0.0006	0.0008	0.001	0.0015	0.002	0.0025	0.003	0.0035	0.004	0.0045
1.2	0.0002	0.0004	0.0006	0.0008	0.001	0.0015	0.002	0.0025	0.003	0.0035	0.004	0.0045
1.3	0.0002	0.0004	0.0006	0.0008	0.001	0.0015	0.002	0.0025	0.003	0.0035	0.004	0.0045
1.4	0.0002	0.0004	0.0006	0.0008	0.001	0.0015	0.002	0.0025	0.003	0.0035	0.004	0.0045
1.5	0.0001	0.0002	0.0005	0.0006	0.0007	0.001	0.0015	0.002	0.0025	0.003	0.0035	0.004
1.6	0.0001	0.0002	0.0005	0.0006	0.0007	0.001	0.0015	0.002	0.0025	0.003	0.0035	0.004
1.7	0.0001	0.0002	0.0005	0.0006	0.0007	0.001	0.0015	0.002	0.0025	0.003	0.0035	0.004
1.8	0.0001	0.0002	0.0005	0.0006	0.0007	0.001	0.0015	0.002	0.0025	0.003	0.0035	0.004
1.9	0.0001	0.0002	0.0005	0.0006	0.0007	0.001	0.0015	0.002	0.0025	0.003	0.0035	0.004
2.1	0.0002	0.0005	0.0007	0.0008	0.001	0.0015	0.002	0.0025	0.003	0.0035	0.004	0.0045
2.2	0.0001	0.0002	0.0004	0.0005	0.0006	0.001	0.0015	0.002	0.0025	0.003	0.0035	0.004
2.3	0.0001	0.0002	0.0004	0.0005	0.0006	0.001	0.0015	0.002	0.0025	0.003	0.0035	0.004
2.4	0.0001	0.0001	0.0003	0.0004	0.0005	0.001	0.0015	0.002	0.0025	0.003	0.0035	0.004
3.1	0.0005	0.0007	0.001	0.0012	0.0015	0.002	0.0025	0.003	0.0035	0.004	0.007	0.01
3.2	0.0005	0.0007	0.001	0.0012	0.0015	0.002	0.0025	0.003	0.0035	0.004	0.007	0.01
3.3	0.0005	0.0007	0.001	0.0012	0.0015	0.002	0.0025	0.003	0.0035	0.004	0.007	0.01
3.4	0.0005	0.0007	0.001	0.0012	0.0015	0.002	0.0025	0.003	0.0035	0.004	0.007	0.01
4.1	0.0002	0.0003	0.0005	0.0006	0.00075	0.001	0.0012	0.0015	0.002	0.0025	0.003	0.0035
4.2	0.0002	0.0001	0.0002	0.0003	0.0005	0.001	0.0012	0.0015	0.002	0.0025	0.003	0.0035
4.3	0.0002	0.0003	0.0004	0.0005	0.0006	0.001	0.0012	0.0015	0.002	0.0025	0.003	0.0035
5.1	0.0002	0.0003	0.0004	0.0005	0.0006	0.001	0.0012	0.0015	0.002	0.0025	0.003	0.0035
5.2	0.0002	0.0003	0.0004	0.0005	0.0006	0.001	0.0012	0.0015	0.002	0.0025	0.003	0.0035
5.3	0.0002	0.0003	0.0004	0.0005	0.0006	0.001	0.0012	0.0015	0.002	0.0025	0.003	0.0035
6.1	0.0002	0.0004	0.0006	0.0008	0.001	0.0015	0.002	0.0025	0.003	0.0035	0.004	0.0045
6.2	0.0002	0.0004	0.0006	0.0008	0.001	0.0015	0.002	0.0025	0.003	0.0035	0.004	0.0045
6.3	0.0002	0.0004	0.0006	0.0008	0.001	0.0015	0.002	0.0025	0.003	0.0035	0.004	0.0045
6.4	0.0002	0.0003	0.0005	0.0006	0.00075	0.001	0.0012	0.0015	0.002	0.0025	0.003	0.0035
7.1	0.0005	0.0007	0.001	0.0012	0.0015	0.002	0.0025	0.003	0.0035	0.004	0.007	0.01
7.2	0.0005	0.0007	0.001	0.0012	0.0015	0.002	0.0025	0.003	0.0035	0.004	0.007	0.01
7.3	0.0005	0.0007	0.001	0.0012	0.0015	0.002	0.0025	0.003	0.0035	0.004	0.007	0.01
7.4	0.0005	0.0007	0.001	0.0012	0.0015	0.002	0.0025	0.003	0.0035	0.004	0.007	0.01
8.1	0.0005	0.0007	0.001	0.0012	0.0015	0.002	0.0025	0.003	0.0035	0.004	0.007	0.01
8.02	0.0005	0.0007	0.001	0.0012	0.0015	0.002	0.0025	0.003	0.0035	0.004	0.007	0.01
8.3	0.0005	0.0007	0.001	0.0012	0.0015	0.002	0.0025	0.003	0.0035	0.004	0.007	0.01
9.1	0.0002	0.0004	0.0006	0.0008	0.001	0.0015	0.002	0.0025	0.003	0.0035	0.004	0.0045

TECHNICAL INFORMATION FOR ENDMILLS













Endmills	2 FL SQ Standard Endmill	3 FL SQ Standard Endmill	4 FL SQ Standard Endmill	2 FL SQ Standard Endmill	3 FL SQ Standard Endmill	4 FL SQ Standard Endmill	2 FL SQ Long Endmill	3 FL SQ Long Endmill	4 FL SQ Long Endmill	2 FL SQ Long Endmill
										
Series	Uncoated 201, 202, 209, 213	Uncoated 210, 213, 201, 202, 540	Uncoated 211, 213, 201, 202	PowerA 209, 241, 254, 253, 204, 213, 243	PowerA 245, 244, 257, 256, 211, 217	PowerA 248, 247, 260, 259, 209, 215, 249	Uncoated 204, 206	Uncoated 204, 206	Uncoated 206	PowerA 255, 224, 226
Material Group	Surface Feet Per Minute									
1.1	260-400	260-400	260-400	525-800	525-800	525-790	160-230	160-230	160-230	330-450
1.2	260-400	260-400	260-400	525-800	525-800	525-790	160-230	160-230	160-230	330-450
1.3	200-260	200-260	200-260	400-525	395-525	395-525	115-165	115-165	115-165	230-330
1.4	200-260	200-260	200-260	395-525	395-525	395-525	115-165	115-165	115-165	230-330
1.5	130-200	130-200	130-200	395-525	395-525	260-525	80-115	80-115	80-115	165-230
1.6	65-130	65-130	65-130	135-270	135-270	130-260	50-65	50-65	50-65	100-150
1.7				135-270	135-270	130-260				100-150
1.8				135-270	135-270	130-260				100-150
1.9										
2.1	130-260	130-260	130-260	260-525	260-525	260-525	80-160	80-160	80-160	160-320
2.2	100-160	100-160	100-160	200-330	200-330	200-330	65-100	65-100	65-100	130-200
2.3	80-130	80-130	80-130	160-260	160-260	160-260	50-80	50-80	50-80	100-160
2.4	70-120	70-120	70-120	150-220	150-220	150-220				80-140
3.1	160-260	160-260	160-260	330-500	330-500	330-500	115-200	115-200	115-200	230-400
3.2	130-230	130-230	130-230	260-460	260-460	260-460	100-160	100-160	100-160	200-330
3.3	115-160	115-160	115-160	230-330	230-330	230-330	80-115	80-115	80-115	160-230
3.4	80-130	80-130	80-130	160-260	160-260	160-260	65-100	65-100	65-100	130-200
4.1	200-330	200-330	200-330	400-650	400-650	400-650	115-200	115-200	115-200	230-395
4.2	130-200	130-200	130-200	260-400	260-400	260-400	80-115	80-115	80-115	160-230
4.3	65-100	65-100	65-100	130-200	130-200	130-200	50-70	50-70	50-70	100-130
5.1	200-330	200-330	200-330	400-650	400-650	400-650	115-200	115-200	115-200	230-395
5.2	100-200	100-200	100-200	200-400	200-400	200-400	65-115	65-115	65-115	130-230
5.3	65-160	65-160	65-160	130-330	130-330	130-330	50-100	50-100	50-100	100-200
6.1	330-660	330-660	330-660	650-1,350	650-1,350	650-1,350	200-400	200-400	200-400	400-800
6.2	425-560	425-560	425-560	850-1,150	850-1,150	850-1,150	330-400	330-400	330-400	660-800
6.3	425-560	425-560	425-560	850-1,150	850-1,150	850-1,150	330-400	330-400	330-400	660-800
6.4	70-160	70-160	70-160	165-330	165-330	165-330	65-115	65-115	65-115	130-230
7.1	500-1,500	500-1,500					330-1,000	330-1,000		
7.2	500-1,500	500-1,500					330-1,000	330-1,000		
7.3	130-260	130-260					100-200	100-200		
7.4	115-160	115-160								
8.1	260-520	260-520					200-400	200-400		
8.2	230-425	230-425					165-330	165-330		
8.3	230-425	230-425					165-330	165-330		
9.1	13-26	13-26	13-26	25-50	25-50	25-50				

SPEEDS AND FEEDS FOR MATERIAL APPLICATIONS













3FL SQ Long Endmill	4 FL SQ Long Endmill	2 FL Square End, Minimill	2 FL Ball End, Minimill	4 FL Square End, Minimill	4 FL Ball End, Minimill	2 FL Square End, Minimill	2 FL Ball End, Minimill	4 FL Square End, Minimill	4 FL Ball End, Minimill
									
PowerA	PowerA	Uncoated	Uncoated	Uncoated	Uncoated	PowerA	PowerA	PowerA	PowerA
228, 227, 229	231, 230, 232	207	207	207	207	207	207	207	207
330-460	330-460	260-400	260-400	260-400	260-400	525-800	525-800	525-800	525-800
330-460	330-460	260-400	260-400	260-400	260-400	525-800	525-800	525-800	525-800
230-330	230-330	200-260	200-260	200-260	200-260	400-525	400-525	400-525	400-525
230-330	230-330	200-260	200-260	200-260	200-260	395-525	395-525	395-525	395-525
165-230	165-230	130-200	130-200	130-200	130-200	395-525	395-525	395-525	395-525
100-150	100-150	65-130	65-130	65-130	65-130	135-270	135-270	135-270	135-270
100-150	100-150					135-270	135-270	135-270	135-270
100-150	100-150					135-270	135-270	135-270	135-270
160-320	160-320	130-260	130-260	130-260	130-260	260-525	260-525	260-525	260-525
130-200	130-200	100-160	100-160	100-160	100-160	200-330	200-330	200-330	200-330
100-160	100-160	80-130	80-130	80-130	80-130	160-260	160-260	160-260	160-260
80-140	80-140	70-120	70-120	70-120	70-120	150-220	150-220	150-220	150-220
230-400	230-400	160-260	160-260	160-260	160-260	330-500	330-500	330-500	330-500
200-330	200-330	130-230	130-230	130-230	130-230	260-460	260-460	260-460	260-460
160-230	160-230	115-160	115-160	115-160	115-160	230-330	230-330	230-330	230-330
135-200	135-200	80-130	80-130	80-130	80-130	160-260	160-260	160-260	160-260
230-400	230-400	200-330	200-330	200-330	200-330	400-650	400-650	400-650	400-650
165-230	165-230	130-200	130-200	130-200	130-200	260-400	260-400	260-400	260-400
100-130	100-130	65-100	65-100	65-100	65-100	130-200	130-200	130-200	130-200
230-400	230-400	200-330	200-330	200-330	200-330	400-650	400-650	400-650	400-650
130-230	130-230	100-200	100-200	100-200	100-200	200-400	200-400	200-400	200-400
100-200	100-200	65-160	65-160	65-160	65-160	130-330	130-330	130-330	130-330
650-800	650-800	330-660	330-660	330-660	330-660	650-1,350	650-1,350	650-1,350	650-1,350
650-800	650-800	425-560	425-560	425-560	425-560	850-1,150	850-1,150	850-1,150	850-1,150
650-800	650-800	425-560	425-560	425-560	425-560	850-1,150	850-1,150	850-1,150	850-1,150
135-230	135-230	70-160	70-160	70-160	70-160	165-330	165-330	165-330	165-330
		500-1,500	500-1,500	500-1,500	500-1,500				
		500-1,500	500-1,500	500-1,500	500-1,500				
		130-260	130-260	130-260	130-260				
		115-160	115-160	115-160	115-160				
		260-520	260-520	260-520	260-520				
		230-425	230-425	230-425	230-425				
		230-425	230-425	230-425	230-425				
		12-25	12-25	12-25	12-25	25-50	25-50	25-50	25-50

Technical Information

TECHNICAL INFORMATION FOR ENDMILLS









Endmills	V4 Stub and Standard	V4 Long	V5 Stub and Standard	V5 Long	Medium Pitch Roughers	Medium Pitch Roughers	HY5 Stub and Standard	HY5 Long	F45 Standard	F45 Standard	AlumaZip	TwisterMill
												
Series	PowerA 400, 402	PowerA 401	PowerA 408, 410	PowerA 409	Uncoated 433	PowerA 433	PowerA 456, 458	PowerA 457	Uncoated 459	PowerA 411	Uncoated 432	Uncoated 452
Material Group	Surface Feet Per Minute											
1.1	500-800	330-450	500-800	330-450	260-395	500-700	500-1,400	325-900				
1.2	500-800	330-450	500-800	330-450	260-395	500-700	500-1,400	325-900				
1.3	400-525	225-330	400-525	225-330	200-260	400-550	330-1,000	220-650				
1.4	400-525	225-330	400-525	225-330	200-260	400-550	330-1,000	220-650	220-650	330-1,000		
1.5	250-400	165-225	330-700	165-225	130-200	250-400	330-650	220-425	220-425	330-650		
1.6	130-250	100-165	330-700	100-165	65-130	125-260	330-650	220-425	220-425	330-650		
1.7	130-250	100-165	330-700	100-165			330-650	220-425	220-425	330-650		
1.8	130-250	100-165	330-700	100-165			330-650	220-425	220-425	330-650		
1.9												
2.1	250-800	165-330	250-800	165-330	130-260	250-550	250-800	160-520	160-520	250-800		165-330
2.2	200-600	125-200	200-600	125-200	100-160	200-325	200-600	130-400	130-400	200-600		135-200
2.3	165-300	100-165	165-300	100-165	80-130	160-260	100-300	65-200	65-200	100-300		80-180
2.4	145-200	110-160	145-200	110-160								
3.1	210-700	225-400	210-700	225-400	160-260	320-550	200-650	130-425				
3.2	180-550	200-330	180-550	200-330	130-230	260-450	165-575	100-380				
3.3	150-450	165-225	150-450	165-225	115-160	230-325	135-460	90-300				
3.4	110-330	125-200	110-330	125-200	80-130	160-260	100-300	65-200				
4.1	200-400	200-330	330-1,000	200-330	200-330	400-650	330-1,000	220-650	220-650	330-1,000		260-425
4.2	125-330	165-225	250-800	165-225	130-200	260-400	260-800	130-520	130-520	260-800		165-260
4.3	130-200	100-125	130-400	100-125	65-100	130-200	130-400	85-260	85-260	130-400		80-135
5.1	330-700	225-400	330-1,000	225-400	200-330	400-650	330-1,000	220-650	220-650	330-1,000		260-425
5.2	250-800	125-225	250-800	125-225	100-200	300-400	260-800	170-520	170-520	260-800		130-260
5.3	130-400	100-200	130-400	100-200	65-160	130-325	130-400	85-260	85-260	130-400		80-230
6.1					330-660							
6.2					425-560							650-850
6.3					425-560							650-850
6.4					65-160							135-260
7.1					160-1,500						1,200-3,000	
7.2					200-1,500						1,200-3,000	
7.3					130-260						1,000-2,500	
7.4					115-160						330-1,500	
8.1					260-520						650-2,000	
8.2					230-425						300-900	
8.3					230-425							
9.1												

SPEEDS AND FEEDS FOR MATERIAL APPLICATIONS

HyperMill	Mold Mills Standard Length	Mold Mills Standard Length	Mold Mills Standard Length	Mold Mills Long Length	Mold Mills Long Length	Mold Mills Long Length	AxMill 2 Flute Standard Length	AxMill 2 Flute Long Length	AxMill 2 Flute Stub Length	AxMill 3 Flute Standard Length	AxMill 3 Flute Long Length	AxMill 3 Flute Stub Length
												
Uncoated	Uncoated	PowerA	PowerN	Uncoated	PowerA	PowerN	Uncoated	Uncoated	Uncoated	Uncoated	Uncoated	Uncoated
428	440	440	440	440	440	440	414	415	416	420	421	422
Surface Feet Per Minute												
	165-230	330-460	460-650	100-140	200-275	280-390						
	165-230	330-460	460-650	100-140	200-275	280-390						
	115-165	230-330	325-460	70-100	140-200	200-280						
	115-165	230-330	325-460	70-100	140-200	200-280						
	85-115	165-230	230-325	50-70	100-140	140-200						
	50-100	100-200	140-280	40-75	60-120	85-170						
	50-100	100-200	140-280	40-75	60-120	85-170						
	50-100	100-200	140-280	40-75	60-120	85-170						
	50-100	130-250	140-280									
	85-165	165-330	230-460	60-120	100-200	140-280						
	70-100	135-200	190-280	50-75	80-120	115-170						
	50-85	100-165	140-230	40-70	60-100	85-140						
	85-150	165-300	230-460	60-110	100-180	140-250						
	100-165	200-330	280-460	75-120	120-200	170-280						
	85-115	165-230	190-280	60-85	100-140	140-200						
	70-100	135-200	190-280	50-75	80-120	115-170						
	115-200	230-400	325-560	70-145	140-240	200-340						
	85-115	165-230	230-325	60-85	100-140	140-200						
	50-70	100-135	140-190	40-50	60-80	85-115						
	115-200	230-400	325-560	70-145	140-240	200-340						
	70-115	135-230	190-325	50-70	80-140	115-200						
	50-100	100-200	140-280	40-75	60-120	85-170						
	200-400	400-800	560-1,100	145-290	240-480	340-670						
	325-400	650-800	900-1,100	235-290	390-480	550-675	800-1,000	800-1,000	800-1,000	800-1,000	800-1,000	800-1,000
	325-400	650-800	900-1,100	235-290	390-480	550-675	600-900	600-900	600-900	600-900	600-900	600-900
	70-115	135-230	190-325	50-70	80-140	115-200	425-560	425-560	425-560	425-560	425-560	425-560
							65-160	65-160	65-160	65-160	65-160	65-160
1,200-3,000							1,200-2,500	1,200-2,500	1,200-2,500	1,200-2,500	1,200-2,500	1,200-2,500
1,200-3,000							600-1,200	600-1,200	600-1,200	600-1,200	600-1,200	600-1,200
1,000 -2,500							500-800	500-800	500-800	500-800	500-800	500-800
330-1,500							300-600	300-600	300-600	300-600	300-600	300-600
650-2,000							650-2,000	650-2,000	650-2,000	650-2,000	650-2,000	650-2,000
300-900							300-900	300-900	300-900	300-900	300-900	300-900
							230-425	230-425	230-425	230-425	230-425	230-425

Technical Information

TECHNICAL INFORMATION FOR PRO+ ENDMILLS

Endmills								
	PowerN 450, 452	PowerNR 451	PowerN 453, 455	PowerNR 454	PowerN 456, 458	PowerNR 457	PowerN 459, 461	PowerNR 460

Material Group	Surface Feet Per Minute							
1.1								
1.2								
1.3	540-700	330-425	540-700	330-425	540-700	330-425	540-700	330-425
1.4	540-700	330-425	540-700	330-425	540-700	330-425	540-700	330-425
1.5	340-550	200-330	340-550	200-330	340-550	200-330	340-550	200-330
1.6	175-350	85-150	175-350	85-150	175-350	85-150	175-350	85-150
1.7	175-350	85-150	175-350	85-150	175-350	85-150	175-350	85-150
1.8	175-350	85-150	175-350	85-150	175-350	85-150	175-350	85-150
1.9	125-250	70-125	125-250	70-125	125-250	70-125	125-250	70-125
2.1	340-1,100	200-660	340-1,100	200-660	340-1,100	200-660	340-1,100	200-660
2.2	270-800	160-480	270-800	160-480	270-800	160-480	270-800	160-480
2.3	225-400	135-240	225-400	135-240	225-400	135-240	225-400	135-240
2.4	200-270	120-160	200-270	120-160	200-270	120-160	200-270	120-160
3.1	445-700	170-570	445-700	170-570	445-700	170-570	445-700	170-570
3.2	350-600	145-450	350-600	145-450	350-600	145-450	350-600	145-450
3.3	310-445	120-360	310-445	120-360	310-445	120-360	310-445	120-360
3.4	210-350	90-270	210-350	90-270	210-350	90-270	210-350	90-270
4.1	550-875	160-330	550-875	160-330	550-875	160-330	550-875	160-330
4.2	350-540	80-270	350-540	80-270	350-540	80-270	350-540	80-270
4.3	175-270	105-165	175-270	105-165	175-270	105-165	175-270	105-165
5.1	540-900	325-540	540-900	325-540	540-900	325-540	540-900	325-540
5.2	270-550	160-330	270-550	160-330	270-550	160-330	270-550	160-330
5.3	175-450	105-370	175-450	105-370	175-450	105-370	175-450	105-370
6.1								
6.2								
6.3								
6.4								
7.1								
7.2								
7.3								
7.4								
8.1								
8.2								
8.3								
9.1								

TECHNICAL INFORMATION FOR AXMILLS

Suggested Axial/Radial Loads

Work Material	Type of Cut	Axial DOC	Radial DOC	Number of Flutes
Aluminum Alloys 2024, 6061, 7075	Slotting	1xD	1xD	2
	Roughing	1xD	.75xD	3
	Finishing	1.5xD	.01xD	3
High Silicon Aluminum A380, A390	Slotting	.5xD	1xD	3
	Roughing	1xD	.5xD	3
	Finishing	1.5xD	.01xD	3
Magnesium Alloys	Slotting	1xD	1xD	2
	Roughing	1xD	.75xD	3
	Finishing	1.5xD	.01xD	3
Copper Alloys, Brass, Bronze	Slotting	.75xD	1xD	2
	Roughing	1xD	.75xD	3
	Finishing	1.5xD	.01xD	3
Composites, Plastics, Fiberglass	Slotting	1xD	1xD	3
	Roughing	1xD	.75xD	3
	Finishing	1.5xD	.01xD	3

TECHNICAL INFORMATION FOR HP ROUTERS

	FGR	Nicked Trimmer CVD Diamond Coated	Herringbone Compression Finisher CVD Diamond Coated	Semi-Finisher CVD Diamond Coated	Multi-Flute Finisher CVD Diamond Coated
Material Group	Surface Feed per Minute				
CFRP, AFRP (Carbon Fiber, Aramid Fiber, Honeycomb Structures)		425-850	425-850	425-850	425-850
GFRP (Fiberglass)	650-1,000	425-850	425-850	425-850	
Carbon, Graphite	650-1,000	425-850	425-850	425-850	425-850
Metal Matrix		425-850		425-850	425-850
Plastics	800-1,650	425-850		425-850	425-850
Plastics	650-1,000	425-850	425-850	425-850	425-850
Carbon & Honeycomb		425-850	425-850		425-850

TECHNICAL INFORMATION FOR REAMERS

Carbide Reamer Feeds and Speeds

Material	Brinell	SFM	1/16"	1/8"	3/16"	1/4"	5/16"	3/8"	1/2"
Carbon Steels 1018, 1020, 1040, 1080 1140, 1212, 12L15 1525, 1536	≤ 200	150	0.002	0.004	0.005	0.007	0.009	0.011	0.014
	>200	75	0.002	0.003	0.005	0.006	0.008	0.009	0.012
	≤ 300								
	>300	55	0.001	0.002	0.003	0.004	0.005	0.006	0.007
	≤ 420								
Alloy Steels 4140, 4150, 4320, 4340 5120, 5150, 8630, 86L20 50100, 52100	≤ 270	115	0.002	0.003	0.005	0.006	0.008	0.009	0.012
	>270	70	0.002	0.003	0.005	0.006	0.008	0.009	0.012
	≤ 370								
	>370	45	0.001	0.002	0.003	0.004	0.005	0.006	0.007
	≤ 450								
Tool Steels A2, D2, H13, L2, M2 P20, S7, T15, W2	≤ 250	40	0.001	0.002	0.003	0.004	0.005	0.006	0.008
	>250	25	0.001	0.001	0.002	0.003	0.003	0.004	0.005
	≤ 330								
	>330	20	0.000	0.001	0.001	0.002	0.002	0.002	0.003
	≤ 450								
Free Machining Stainless 303, 400 Series	≤ 250	75	0.001	0.002	0.003	0.004	0.005	0.006	0.008
	>250	55	0.001	0.002	0.002	0.003	0.004	0.005	0.006
	≤ 330								
Difficult Stainless 304, 316, 321, 15-5 PH, 17-4 PH Nitronic® 32	≤ 270	35	0.001	0.002	0.003	0.004	0.005	0.006	0.008
	>270	25	0.001	0.001	0.002	0.003	0.003	0.004	0.005
	≤ 370								
Cast Iron Gray, Malleable, Ductile	≤ 200	125	0.002	0.004	0.006	0.008	0.010	0.012	0.016
	>200	95	0.002	0.004	0.006	0.008	0.010	0.012	0.016
	≤ 330								
Titanium Ti-6Al4V, Ti-7Al4Mo Ti-5Al-5VMo-3Cr Ti-8Al1Mo1V	≤ 280	45	0.002	0.003	0.005	0.006	0.008	0.009	0.012
	>280	35	0.001	0.002	0.003	0.004	0.005	0.006	0.008
	≤ 350								
	>350	25	0.001	0.001	0.002	0.003	0.003	0.004	0.005
	≤ 440								
High Temp (Nickel) Alloys A-286, Hastelloy®, Incoloy®, Inconel®, Rene®, Waspaloy®	≤ 220	20	0.001	0.002	0.002	0.003	0.004	0.005	0.006
	>220	15	0.001	0.001	0.002	0.003	0.003	0.004	0.005
	≤ 330								
	>330	10	0.000	0.001	0.001	0.002	0.002	0.002	0.003
	≤ 420								
Copper Alloys Aluminum Bronze, C110 Aluminum 6061, 7075, 2017, 2024, 356	≤ 140	115	0.001	0.003	0.004	0.005	0.006	0.008	0.010
	≥ 140	95	0.001	0.003	0.004	0.005	0.006	0.008	0.010
	≤ 80	270	0.003	0.005	0.008	0.010	0.013	0.015	0.020
	≥ 80	230	0.003	0.005	0.008	0.010	0.013	0.015	0.020

TECHNICAL INFORMATION FOR HP DRILLS

Hurricane Drills Feeds and Speeds

Material	Rockwell Hardness "C"	SFM		Chip Load per Drill Diameter (Starting)				
		Solid	Coolant-Thru	1/8"-1/4"	1/4"-3/8"	3/8"-1/2"	1/2"-5/8"	5/8"-3/4"
Carbon Steels A-36, 12L14, SAE 1000, 1100,1300	<35	200	300	.0015-.0025	.0025 - .003	.003 - .0035	.0035 -.0045	.0045 -.0065
	>35	175	240	.0005 - .0015	.0015-.0025	.0025 - .003	.003 - .0035	.0035-.0045
Medium Alloy Steel 200, 250, 300, 8620	<35	200	300	.0015-.0025	.0025 - .003	.003 - .0035	.0035 -.0045	.0045 -.0065
	>35	175	240	.0005 - .0015	.0015-.0025	.0025 - .003	.003 - .0035	.0035-.0045
High Strength Alloy Steel 4140, 4340,5210,A2, D2P20, H11, H13, S2, O1	<35	200	300	.0015-.0025	.0025 - .003	.003 - .0035	.0035 -.0045	.0045 -.0065
	>35	175	240	.0005 - .0015	.0015-.0025	.0025 - .003	.003 - .0035	.0035-.0045
Cast Material Cast Steel Ductile Iron Gray iron		200	300	.0025 - .0035	.0035 -.0045	.0035 -.0045	.0045 -.0055	.0055 -.0075
		250	350	.0025 - .0035	.0035 -.0045	.0035 -.0045	.0045 -.0055	.0055 -.0075
		250	400	.0025 - .0035	.0035 -.0045	.0035 -.0045	.0045 -.0055	.0055 -.0075
Aluminum 2024, 6061-T6, 7075 Die Cast, Extrusions		300-400	300-600	.0035 -.0045	.0045-.0055	.0065 - .0075	.0085-.0095	.0085-.0095
		250-300	300-500	.0025 - .0035	.0035 -.0045	.0055-.0065	.0075 - .0085	.0075 - .0085
Stainless Steels 200 Series, 300 Series	< 35	225	300	.0015-.0025	.0025 - .003	.003 - .0035	.0035-.0045	.004-.0055
	> 35	175	240	.0005-.0015	.0015-.002	.002-.0025	.0025-.0035	.0035-.0045
304L, 316L, Nitronic 50	< 35	125	175	.001-.0015	.0015-.002	.002-.003	.003 - .004	.004-.005
	> 35	75	100	.0005 - .001	.001-.0015	.0015 - .0025	.0025 - .0035	.0035 -.0045
400 Series (Martensitic)	< 35	225	300	.0015-.0025	.0025 - .003	.003 - .0035	.0035 -.0045	.004-.0055
	> 35	175	240	.0005 - .0015	.0015-.0025	.0025 - .003	.003 - .0035	.0035 -.0045
15/5, 17-4, (Precipitation)	< 35	225	30	.0015 - .0025	.0025 - .003	.003 - .0035	.0035 -.0045	.004-.005
	> 35	175	240	.0005 - .0015	.0015-.0025	.0025 - .003	.003 - .0035	.0035-.0045
Nickel Alloys Inconel, Waspalloy Rene, Hastalloy	< 35	175	250	.001-.002	.002-.003	.0025 - .0035	.003-.004	.0035-.0055
	> 35	125	200	.0005 - .0015	.0015-.0025	.002-.003	.0025 - .0035	.003-.0035
Cobalt Alloys Stellite, Haynes X-40	< 35	185	225	.001-.002	.002-.003	.0025-.0035	.003 - .004	.0035-.0055
	> 35	125	180	.0005-.0015	.0015-.0025	.002-.003	.0025-.0035	.003 - .0035
Titanium Alloys 6AL-4V, 6AJ-25N		225	300	.001-.002	.002-.003	.0025 - .0035	.003 - .004	.0035-.0055
Monel		150	225	.001-.002	.002-.003	.0025"- .0035	.003 - .004	.0035-.0055

TERMS AND CONDITIONS

To Order

Faxed or e-mailed orders are required. Please specify quantity and EDP/Part numbers.

Minimum Orders

\$50 for standard items, \$200 for special orders. Orders below \$50 are subject to a \$7.50 handling fee.

Standard Payment Terms

Overseas customers: Prepaid.

US customers: Net 30 Days, pending credit approval, past due after 30 days from billing date.

Freight

Freight is F.O.B. Origin. Mastercut Tool Corp. offers daily service with FedEx and UPS. Shipments made Pre-Pay & Add on Mastercut's FedEx or UPS accounts are subject to a \$2.50 handling fee for domestic shipments and a \$25.00 handling fee for international shipments. We are also happy to utilize any freight carrier when shipping on a collect or third-party account with no additional handling fee.

Return Policy

Standard items that Mastercut maintains in stock may be returned with a 25% restocking fee. All returns must be received within 2 months of original ship date in the original packaging. We are unable to accept returns on non-stock items or specials.

ADDITIONAL OFFERINGS

Special Tooling for your Requirements

When you need a non-standard tool for a specific job, give us a call. Requirements for special tooling or modifications of existing standard items will be given prompt, expert attention.

Resharpening

Mastercut Tool Corp. employs skilled craftsmen and advanced equipment to provide excellent resharpening services. We can sharpen dull cutters, regardless of the manufacturer. This is an excellent and efficient way to get new tool performance at a fraction of the cost.

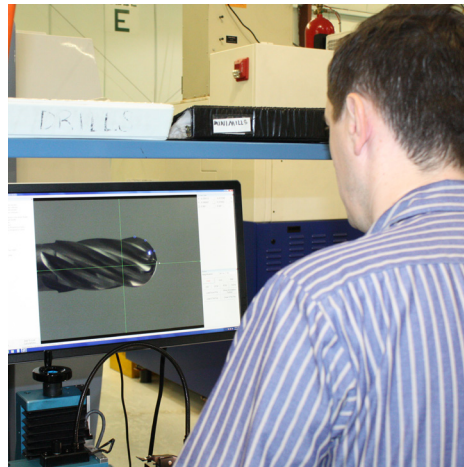
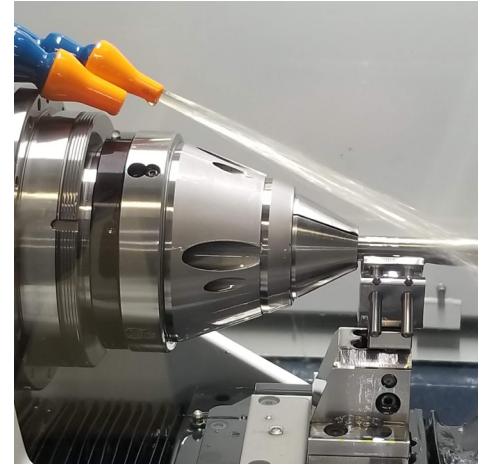
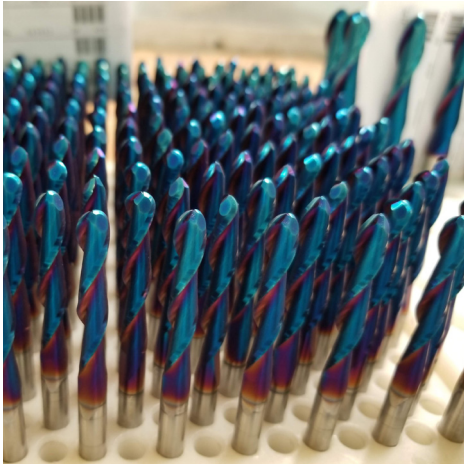
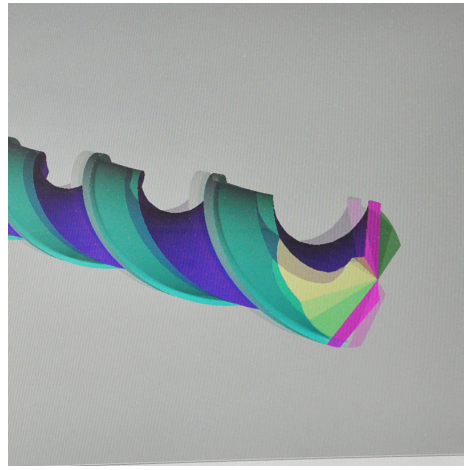
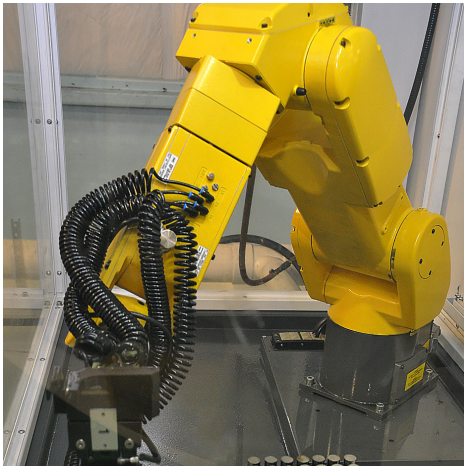

Mastercut Tool Corp. - Corporate Headquarters
965 Harbor Lake Dr.
Safety Harbor, Florida 34695 USA
Tel: (727) 726-5336
Fax: (727) 725-2532

Mastercut Tool Corp. - European Warehouse
Heliumstraat 8
7463PL Rijssen
Netherlands
Tel: +31 404 002839

Email: sales@mastercuttool.com
Web: www.mastercuttool.com

Additional US Warehouses
located in California, Michigan and Texas



SOLID CARBIDE ENDMILLS



HIGH PERFORMANCE ENDMILLS

PRO+ PERFORMANCE



ROUTERS FOR WOOD, PLASTIC, AND FIBERGLASS

DRILLS, COUNTERSINKS

REAMERS



CARBIDE BURS - SOLID AND BRAZED SHANK



Mastercut Tool Corp. - Corporate Headquarters
 965 Harbor Lake Dr.
 Safety Harbor, Florida 34695 USA
 Tel: (727) 726-5336
 Fax: (727) 725-2532

Mastercut Tool Corp. - European Warehouse
 Heliumstraat 8
 7463PL Rijssen
 Netherlands
 Tel: +31 404 002839

Email: sales@mastercuttool.com
 Web: www.mastercuttool.com



Proudly Distributed By:

