

# MasterCut

Tool Corp.



*The Cutting Edge **M**astered*

## SOLID CARBIDE ROUTER TOOLING



**FRACTIONAL AND METRIC  
ROUTERS FOR WOOD, PLASTIC, AND FIBERGLASS**



**Please contact us for  
our Rotary Cutting Tools  
Catalog, with our full line of  
metalworking products**



**Rotary Cutting Tools catalog is available in  
metric in the following languages:**

**Chinese  
English  
French  
German  
Italian**

**Japanese  
Korean  
Portuguese  
Russian  
Spanish**



# About Mastercut

## Our History

1985	Incorporated in Safety Harbor, Florida
1986	Form grinding and brazing operations are added
1989	Company builds its first machine for manufacturing burs
1989	First CNC machine is purchased to help with quality and growth
1991	Production of endmills commences
1994	5 and 6 axis CNC machines purchased for volume production of burs, endmills and drills
1995	Laser marking introduced; laser inspection systems implemented
1999	Cell concept introduced in a new facility for greater production and quality control
2002	Production of spiral router bits, drills, and reamers commences
2003	ISO 9001:2000 certification achieved; first coating machine purchased
2004	MAP, Mastercut's Automated Production system developed
2005	CNC1st team (Customers' Needs Come 1st) implemented; second coating machine added
2006	Production begins on high-performance endmills, drills, and miniature tooling
2009	ISO 9001:2008 certification achieved
2011	New surface treatments introduced
2013	Nano coatings and Pro+ performance tools introduced
2015	Mastercut celebrates 30th anniversary, and facility expansion
2016	Warehouse expansions in USA and Europe
2018	ISO 9001:2015 certification achieved
2025	Recognizing 40 years, and the implementation of numerous advanced technologies

## Today

Mastercut Tool Corp. celebrates 4 decades as a world class carbide cutting tool manufacturer. From inception to the present, our goal is providing the highest quality products and services to our customers. All products are still manufactured in Florida, using state of the art equipment, skilled craftspersons and our exclusive MAP technology.

## Our Thanks to Our Loyal Customers and Associates

Our history would not be possible without the support of all those associated with us. We thank all of our customers and associates, as well as our community, for your dedication and loyalty. We pledge to continuously improve for you!

## Please check out the following catalogs and services:

- Fractional and metric rotary carbide tooling
- Solid carbide fractional and metric routers
- Capabilities to produce your special tools for all applications
- Authorized reconditioning factory for complete regrind and reconditioning services

# Legend

The cube icons shown below indicate the preferred application for each tool group. You will find them displayed in header of each part listing.





































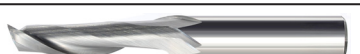

<b>General Wood Products</b>		<b>Soft Wood Products</b>		<b>Hard Wood Products</b>	
<b>Soft Plastics</b>		<b>Phenolics and Hard Plastics</b>		<b>Solid Surface</b>	
<b>Aluminum</b>		<b>Fiberglass</b>		<b>Composites &amp; Laminates</b>	

# Table of Contents

## About Us





About Us.....3

## Single Flute Routers

	<b>OFX</b> Single Flute 'O' Flute Xtreme Upcut (Crescent End) ..... 8				
	<b>OFX</b> Single Flute 'O' Flute Xtreme Downcut (Crescent End) ..... 9				
	Single 'V' Flute Straight Cut (Crescent End).....10				
	Single 'O' Flute Straight Cut (Crescent End) .....10				
	Single 'V' Flute Edge Rounding Straight Cut (Crescent End) .....11				
	Single 'O' Flute Upcut Edge Rounding Spiral Cut (Crescent End) .....11				
	Single 'O' Flute Upcut Spiral (Crescent End) .....12				
	Single 'O' Flute Downcut Spiral (Crescent End) .....14				
	Single Flute Upcut Spiral (Endmill End).....16				
	Single Flute Downcut Spiral (Endmill End) .....17				

# Table of Contents

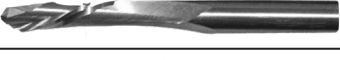
## Single Flute Routers - Cont.

	<b>Single Flute Veining Bit</b> (Endmill End) .....18	GW		
	<b>Single Flute Compression Spiral</b> (Endmill End) .....18	GW		
	<b>Single Flute Ball Compression Spiral</b> (Endmill End) .....19	GW		
	<b>Single Flute Mortise Compression</b> (Endmill End) ..... 20	GW		
	<b>Two Flute Straight Cut</b> (Endmill End) .....21	GW	HP	

## Two Flute Routers

	<b>Two Flute Straight Cut</b> (Plunge Fishtail End) .....22	SW	HP	
	<b>Two Flute Edge Rounding Straight "V" Flute</b> (Crescent End) .....23	GW	SP	HP
	<b>Two Flute Shear V Bottom</b> (90° Point) ..... 24	GW		
	<b>Two Flute 'O' Flute Straight Cut</b> (Edge Rounding)..... 24	GW	SP	HP
	<b>Two Flute 'O' Flute Straight Cut</b> (Endmill End) .....25		SP	HP
	<b>Two Flute Upcut Sprial</b> (Plunge Fishtail End)..... 26	GW		
	<b>Two Flute Downcut Sprial</b> (Fishtail End) .....27	GW		
	<b>Two Flute Upcut Spiral</b> (Endmill End) ..... 28		HP	AL
	<b>Two Flute Downcut Spiral</b> (Endmill End) ..... 29		HP	AL
	<b>High Impact Two Flute Upcut Spiral</b> (Endmill End)..... 30	GW		
	<b>High Impact Two Flute Downcut Spiral</b> (Endmill End)..... 30	GW		
	<b>Two Flute 'O' Flute Upcut Slow Spiral</b> (Endmill End).....31		HP	AL
	<b>Two Flute 'O' Flute Downcut Slow Spiral</b> (Endmill End) .....31		HP	AL
	<b>Two Flute Upcut Slow Helix</b> (Endmill End) .....32	GW		
	<b>Two Flute Downcut Slow Helix</b> (Fishtail End) .....33	GW		
	<b>Two Flute Upcut Spiral Chipbreaker</b> (Endmill End) ..... 34	GW		
	<b>Two Flute Downcut Spiral Chipbreaker</b> (Endmill End).....35	GW		

# Table of Contents

## Two Flute Routers - Cont.







	High Impact Two Flute Upcut Spiral Chipbreaker (Endmill End) . . . . .	36	GW		
	High Impact Two Flute Downcut Spiral Chipbreaker (Endmill End) . . .	36	GW		
	Two Flute Compression (Endmill End) . . . . .	37	GW		
	Two Flute Mortise Compression (Endmill End) . . . . .	38	GW		
	Two Flute Chipbreaker Compression (Endmill End) . . . . .	39	GW		
	Two Flute Ball Round Bottom (3° Slow Helix, Ball End) . . . . .	40	GW		
	Two Flute Straight Rout and Chamfer (Endmill End) . . . . .	40		SP	HP
	Two Flute Bottom Surface Corner Radius Upcut (Endmill End) . . . . .	41	GW		

## Three Flute Routers

















	Three Flute Straight Flute (Endmill End) . . . . .	41	GW		
	Three Flute Upcut Spiral (Endmill End) . . . . .	42	GW		HP
	Three Flute Downcut Spiral (Endmill End) . . . . .	43	GW		HP
	Three Flute Upcut Slow Spiral (Endmill End) . . . . .	44		SP	HP
	Three Flute Downcut Slow Spiral (Endmill End) . . . . .	45		SP	HP
	Three Flute Upcut Slow Helix Ripper (Endmill End) . . . . .	46	GW	SP	HP
	Three Flute Downcut Slow Helix Ripper (Endmill End) . . . . .	47	GW	SP	HP
	Three Flute Upcut High Helix Ripper (Endmill End) . . . . .	48	GW	SP	HP
	Three Flute Downcut High Helix Ripper (Endmill End) . . . . .	49	GW	SP	HP
	High Impact Three Flute Upcut Spiral Ripper (Endmill End) . . . . .	50	GW	SP	HP
	High Impact Three Flute Downcut Spiral Ripper (Endmill End) . . . . .	50	GW	SP	HP
	Three Flute Upcut Lock Mortise (Endmill End) . . . . .	51	GW		
	Three Flute Upcut Spiral Chipbreaker Finisher (Endmill End) . . . . .	52	GW		
	Three Flute Downcut Spiral Chipbreaker Finisher (Endmill End) . . . . .	53	GW		
	Three Flute Upcut Phenolic (Endmill End) . . . . .	54		C&L	HP

# Table of Contents





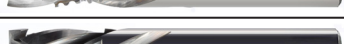



## Three Flute Routers - Cont.

	<b>Three Flute Downcut Phenolic</b> (Endmill End) ..... 54		
	<b>Three Flute Compression</b> (Endmill End) ..... 55		
	<b>Three Flute Mortise Compression</b> (Endmill End) ..... 56		

## Four Flute Routers

	<b>Four Flute Upcut Spiral</b> (Endmill End) ..... 57		
	<b>Four Flute Downcut Spiral</b> (Endmill End) ..... 57		
	<b>High Velocity Four Flute Upcut Combination Spiral</b> (Endmill End) .... 58		
	<b>High Velocity Four Flute Downcut Combination Spiral</b> (Endmill End) . 58		
	<b>Four Flute Compression</b> (Endmill End) ..... 59		
	<b>Four Flute Combination Compression</b> (Endmill End) ..... 59		
	<b>Four Flute Mortise Compression</b> (Endmill End) ..... 60		

## Special Application Routers

	<b>Laminate Trimmers</b> (Bevel Flush - Round End) ..... 60		
	<b>Laminate Trimmers</b> (7° Bevel - Round End) ..... 60		
	<b>Aramid Router - Five Flute Upcut/ Two Flute Downcut</b> (Endmill End) . . .61		
	<b>Fiberglass Routers</b> (Plain, Bur, Mill, Drill Ends) ..... 61		

# Single Upcut Flute 'O' Flute Xtreme

## Crescent End



Finish-Top: Inferior  
Finish-Bottom: Excellent  
End Point Type: Crescent  
Helix Angle: 25°

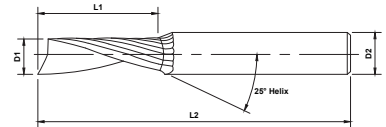

## 823-0 Fractional Upcut



OD	LOC	SHK	OAL	Soft Plastic, General Wood	Hard Plastic, Aluminum
D1	L1	D2	L2	Part ID	Part ID
1/16	1/4	1/8	2	823-002	823-502
	1/4	1/4	2	823-056	823-556
1/8	1/4	1/8	2	823-004	823-504
	1/4	1/4	2	823-006	823-506
	1/2	1/8	2	823-008	823-508
	1/2	1/4	2	823-010	823-510
	3/4	1/4	2-1/2	823-046	823-546
5/32	9/16	1/4	2	823-012	823-512
3/16	3/8	3/16	2	823-014	823-514
	3/8	1/4	2	823-018	823-518
	1/2	1/4	2	823-020	823-520
	5/8	3/16	2	823-016	823-516
	5/8	1/4	2	823-022	823-522
	7/8	1/4	2-1/2	823-042	823-542
	1-1/4	1/4	3	823-040	823-540
7/32	3/4	1/4	2-1/2	823-024	823-524
1/4	3/8	1/4	2-1/2	823-050	823-550
	5/8	1/4	2	823-026	823-526
	3/4	1/4	2-1/2	823-028	823-528
	1	1/4	2-1/2	823-048	823-548
	1-1/4	1/4	3	823-030	823-530
	1-1/2	1/4	3	823-044	823-544
3/8	3/4	3/8	3	823-038	823-538
	1-1/8	3/8	3	823-032	823-532
	1-5/8	3/8	3-1/2	823-054	823-554
1/2	1	1/2	3	823-034	823-534
	1-1/2	1/2	4	823-052	823-552
	2	1/2	4	823-036	823-536

Append -5 for PowerN or -4 for PowerZ Performance Coating to the Part ID

## 923-0 Metric Upcut



OD	LOC	SHK	OAL	Soft Plastic, General Wood	Hard Plastic, Aluminum
D1	L1	D2	L2	Part ID	Part ID
2	8	3	50	923-032	923-532
	8	6	63	923-034	923-534
3	6	3	50	923-002	923-502
	6	6	50	923-008	923-508
	12	3	50	923-004	923-504
	12	6	50	923-010	923-510
	12	6	63	923-018	923-518
4	12	6	63	923-020	923-520
	14	6	50	923-012	923-512
5	10	5	50	923-006	923-506
	10	6	50	923-014	923-514
	16	6	50	923-016	923-516
6	19	6	63	923-022	923-522
	30	6	75	923-024	923-524
8	25	8	63	923-028	923-528
	38	8	75	923-030	923-530
10	28	10	75	923-026	923-526

Append -5 for PowerN or -4 for PowerZ Performance Coating to the Part ID

# OFX

Our OFX line stands for 'O' Flute Xtreme and it's a tool option that you should seriously consider. OFX routers combine premium submicron carbide, a quicker helix, and a highly polished flute that guarantees you a sharper cutting edge, and enhanced flute lubricity for both superior chip evacuation and resistance to 'Built Up Edge' in a broad range of applications. The OFX series is available in a variety of coatings: PowerA, PowerDLC, PowerT, PowerZ, and now PowerN (See Page 9 for details)



# Single Downcut Flute 'O' Flute Xtreme

## Crescent End

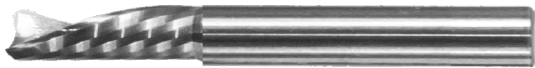

Finish-Top: Excellent  
Finish-Bottom: Inferior  
End Point Type: Crescent  
Helix Angle: 25°

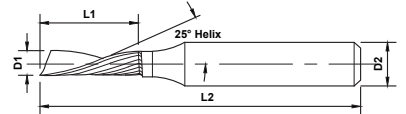

## 823-1 Fractional Downcut



OD	LOC	SHK	OAL	Soft Plastic, General Wood	Hard Plastic, Aluminum
D1	L1	D2	L2	Part ID	Part ID
1/16	1/4	1/8	2	823-102	823-602
	1/4	1/4	2	823-156	823-656
1/8	1/4	1/8	2	823-104	823-604
	1/4	1/4	2	823-106	823-606
	1/2	1/8	2	823-108	823-608
	1/2	1/4	2	823-110	823-610
	3/4	1/4	2-1/2	823-146	823-646
	5/32	9/16	1/4	2	823-112
3/16	3/8	3/16	2	823-114	823-614
	3/8	1/4	2	823-118	823-618
	1/2	1/4	2	823-120	823-620
	5/8	3/16	2	823-116	823-616
	5/8	1/4	2	823-122	823-622
	7/8	1/4	2-1/2	823-142	823-642
	1-1/4	1/4	3	823-140	823-640
7/32	3/4	1/4	2-1/2	823-124	823-624
1/4	3/8	1/4	2-1/2	823-150	823-650
	5/8	1/4	2	823-126	823-626
	3/4	1/4	2-1/2	823-128	823-628
	1	1/4	2-1/2	823-148	823-648
	1-1/4	1/4	3	823-130	823-630
	1-1/2	1/4	3	823-144	823-644
3/8	3/4	3/8	3	823-138	823-638
	1-1/8	3/8	3	823-132	823-632
	1-5/8	3/8	3-1/2	823-154	823-654
1/2	1	1/2	3	823-134	823-634
	1-1/2	1/2	4	823-152	823-652
	2	1/2	4	823-136	823-636

Append -5 for PowerN or -4 for PowerZ Performance Coating to the Part ID



*For even greater performance, specify PowerN coating*

- High nano-hardness increases hardness 2-1/2 times
- An outstanding heat and oxidation barrier
- Ultra thin coating helps retain a super sharp edge

## 923-1 Metric Downcut



OD	LOC	SHK	OAL	Soft Plastic, General Wood	Hard Plastic, Aluminum
D1	L1	D2	L2	Part ID	Part ID
2	8	3	50	923-132	923-632
	8	6	63	923-134	923-634
3	6	3	50	923-102	923-602
	6	6	50	923-108	923-608
	12	3	50	923-104	923-604
	12	6	50	923-110	923-610
	12	6	63	923-118	923-618
4	12	6	63	923-120	923-620
	14	6	50	923-112	923-612
5	10	5	50	923-106	923-606
	10	6	50	923-114	923-614
	16	6	50	923-116	923-616
6	19	6	63	923-122	923-622
	30	6	75	923-124	923-624
8	25	8	63	923-128	923-628
	38	8	75	923-130	923-630
	28	10	75	923-126	923-626

Append -5 for PowerN or -4 for PowerZ Performance Coating to the Part ID

# Single 'V' Flute Straight Cut

## Crescent End



Finish-Top: Good  
Finish-Bottom: Good  
End Point Type: Crescent

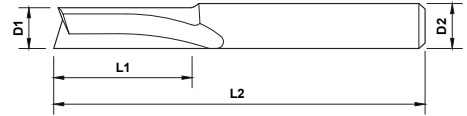

### 800-1 Fractional



OD	LOC	SHK	OAL	General Wood
D1	L1	D2	L2	Part ID
1/8	1/2	1/4	2	800-002
3/16	3/4	1/4	2	800-004
1/4	7/8	1/4	2-1/2	800-006
	1	1/4	2-1/2	800-008
5/16	1-1/8	5/16	3	800-010
3/8	1-1/8	3/8	3	800-012
1/2	1-1/8	1/2	3	800-014

# Single 'O' Flute Straight Cut

## Crescent End

### 800-1 Fractional



OD	LOC	SHK	OAL	Soft and Hard Plastics
D1	L1	D2	L2	Part ID
1/8	1/2	1/8	2	800-102
	5/8	1/8	3	800-104
	5/16	1/4	2	800-106
	1/2	1/4	2	800-108
	1/2	1/4	2	800-110 (Left Hand)
	5/8	1/4	4	800-112
5/32	9/16	1/4	2	800-114
3/16	5/8	3/16	2-1/2	800-116
	3/8	1/4	2	800-118
	5/8	1/4	2	800-120
	5/8	1/4	2	800-122 (Left Hand)
	1	1/4	4	800-124
	7/32	5/8	1/4	2-1/2
1/4	3/8	1/4	2-1/2	800-128
	3/4	1/4	2-1/2	800-130
	3/4	1/4	2-1/2	800-132 (Left Hand)
	3/4	1/4	3-1/2	800-134
	3/4	1/4	3-1/2	800-136 (Left Hand)
	1-1/4	1/4	4	800-138
	1	1/4	2-1/2	800-140
	1	1/4	3-1/4	800-142
3/8	5/8	3/8	2-1/2	800-144
	7/8	3/8	2-1/2	800-146
	1-5/8	3/8	6	800-148
1/2	1-5/8	1/2	4	800-150
	2-1/8	1/2	6	800-152
	1	1/2	3	800-154

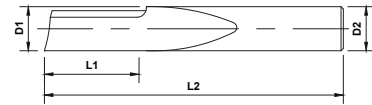

Finish-Top: Good  
Finish-Bottom: Good  
End Point Type: Crescent

### 900-1 Metric



OD	LOC	SHK	OAL	Soft and Hard Plastics
D1	L1	D2	L2	Part ID
4	16	6	64	900-102
5	20	6	64	900-104
6	25	6	64	900-106
8	25	8	64	900-108
10	35	10	88	900-110
12	35	12	88	900-112

# Single 'V' Flute Straight Cut

## Edge Rounding Crescent End



Finish-Top: Excellent  
 Finish-Bottom: Excellent  
 End Point Type: Crescent  
 Helix Angle: 0°

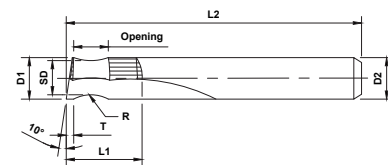

### 800-3 Fractional



OD	LOC	SHK	OAL	Opening	Radius	Small Diameter	Tip to Radius	General Wood
D1	L1	D2	L2		R	SD	T	Part ID
	3/8	1/4	2-1/2	5/32	1/8	.195	1/16	800-302
1/4	3/8	1/4	2-1/2	7/32	3/16	.180	1/16	800-304
	3/8	1/4	2-1/2	9/32	1/4	.163	1/16	800-306

# Single 'O' Flute Upcut Spiral Cut

## Edge Rounding Crescent End



Finish-Top: Excellent  
 Finish-Bottom: Excellent  
 End Point Type: Crescent  
 Helix Angle: 22°

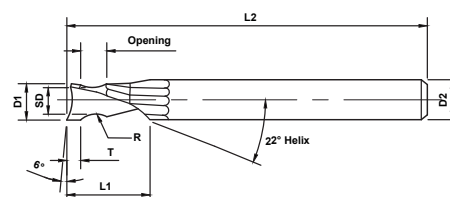

### 800-4 Fractional



OD	LOC	SHK	OAL	Opening	Radius	Small Diameter	Tip to Radius	General Wood
D1	L1	D2	L2		R	SD	T	Part ID
	3/8	1/4	2-1/2	5/32	1/8	.195	1/16	800-402
1/4	3/8	1/4	2-1/2	7/32	3/16	.180	1/16	800-404
	3/8	1/4	2-1/2	9/32	1/4	.163	1/16	800-406

# Single 'O' Flute Upcut Spiral

## Crescent End



Finish-Top: Inferior  
 Finish-Bottom: Excellent  
 End Point Type: Crescent  
 Helix Angle: 21°

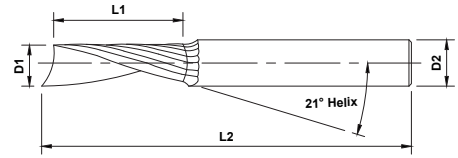

### 801-0, 801-3, 801-5 Fractional



OD	LOC	SHK	OAL	Soft Plastic - Solid Surface	Hard Plastic - Solid Surface	General Wood
D1	L1	D2	L2	Part ID	Part ID	Part ID
1/16	1/4	1/8	2	801-002	801-302	-
	1/4	1/4	2	801-004	801-304	-
1/8	1/4	1/8	1-1/2	-	-	801-502
	1/4	1/8	2	801-006	801-306	-
	1/2	1/8	2	801-010	801-308	-
	1/4	1/4	2	801-008	801-310	801-504
	1/2	1/4	2	801-012	801-312	801-506
5/32	9/16	1/4	2	801-014	801-314	-
3/16	3/8	3/16	1-1/2	-	-	801-508
	3/8	3/16	2	801-016	801-316	-
	3/8	1/4	2	801-020	801-320	801-510
	5/8	3/16	2	-	801-318	-
	5/8	1/4	2	801-022	801-322	801-512
7/32	3/4	1/4	2-1/2	801-024	801-324	-
1/4	3/8	1/4	2	801-026	801-326	801-514
	3/4	1/4	2-1/2	801-028	801-328	801-516
	1-1/4	1/4	3	801-030	801-330	801-518
5/16	3/4	1/2	3	-	-	801-524
21/64	3/4	1/2	3	-	-	801-526
3/8	3/4	3/8	3	-	-	801-520
	1-1/8	3/8	3	801-032	801-332	801-522

# Single 'O' Flute Upcut Spiral

## Crescent End



Finish-Top: Inferior  
 Finish-Bottom: Excellent  
 End Point Type: Crescent  
 Helix Angle: 21°

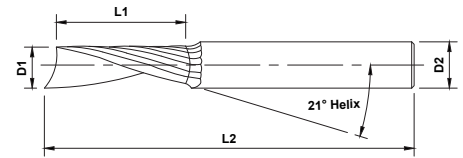

### 900-0, 900-3, 900-5 Metric



OD	LOC	SHK	OAL	Soft Plastic - Solid Surface	Hard Plastic - Solid Surface	General Wood
D1	L1	D2	L2	Part ID	Part ID	Part ID
2	6	2	50	-	-	901-502
	6	6	64	-	-	901-504
	8	2	50	901-002	901-302	-
	8	6	64	901-004	901-304	-
2.5	6	2.5	50	-	-	901-506
	6	6	64	-	-	901-508
	8	2.5	50	901-006	901-306	-
	8	6	64	901-008	901-308	-
3	8	3	50	901-010	901-310	901-510
	8	6	64	901-012	901-312	901-512
	12	3	64	901-014	901-314	901-514
	12	6	64	901-016	901-316	901-516
4	8	4	64	901-018	901-318	901-518
	12	4	64	901-020	901-320	901-520
	20	4	64	901-022	901-322	901-522
	20	6	64	901-024	901-324	901-524
	30	4	64	901-026	901-326	901-526
5	16	5	64	901-028	901-328	901-528
	16	6	64	901-030	901-330	901-530
	30	5	64	901-032	901-332	901-532
6	8	6	64	901-034	901-334	901-534
	12	6	64	901-036	901-336	901-536
	20	6	64	901-038	901-338	901-538
	20	6	100	-	-	901-550
	30	6	76	901-040	901-340	901-540
	38	6	76	901-042	901-342	901-542
8	20	8	100	-	-	901-552
	25	8	64	901-044	901-344	901-544
	38	8	76	901-046	901-346	901-546
10	25	10	120	-	-	901-554
	30	10	76	901-048	901-348	901-548
	35	10	76	901-050	901-350	-
12	25	12	120	-	-	901-558
	38	12	76	-	-	901-556

# Single 'O' Flute Downcut Spiral

## Crescent End



Finish-Top: Excellent  
 Finish-Bottom: Inferior  
 End Point Type: Crescent  
 Helix Angle: 21°

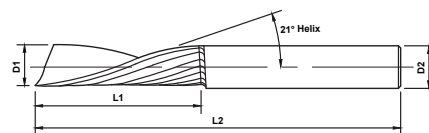

### 801-1, 801-4, 801-6 Fractional



OD	LOC	SHK	OAL	Soft Plastic - Solid Surface	Hard Plastic - Solid Surface	General Wood
D1	L1	D2	L2	Part ID	Part ID	Part ID
1/8	1/4	1/8	1-1/2	-	-	801-602
	1/4	1/4	2	-	-	801-604
	1/2	1/8	1-1/2	801-134	-	-
	1/2	1/8	2	801-110	801-408	-
	1/2	1/4	2	801-112	801-412	-
	1/2	1/4	2	-	-	801-606
5/32	9/16	1/4	2	801-114	801-414	-
3/16	3/8	3/16	1-1/2	-	-	801-608
	3/8	3/16	2	801-116	-	-
	3/8	1/4	2	801-120	801-420	801-610
	1/2	3/16	2	801-136	-	-
	1/2	1/4	2	801-138	-	-
	5/8	3/16	2	801-118	801-418	-
	5/8	1/4	2	801-122	-	-
7/32	3/4	1/4	2-1/2	-	801-422	801-612
1/4	3/8	1/4	2	801-124	801-424	-
	3/8	1/4	2	801-126	-	801-614
	3/8	1/4	2-1/2	801-140	-	-
	3/4	1/4	2-1/2	801-128	801-428	801-616
5/16	1-1/4	1/4	3	801-130	801-430	801-618
	3/4	1/2	3	-	-	801-624
21/64	3/4	1/2	3	-	-	801-626
3/8	3/4	3/8	3	-	-	801-620
	1-1/8	3/8	3	801-132	801-432	801-622
1/2	1	1/2	3	801-144	-	-
	1-5/8	1/2	3-1/2	801-142	-	-

# Single 'O' Flute Downcut Spiral

## Crescent End



Finish-Top: Excellent  
 Finish-Bottom: Inferior  
 End Point Type: Crescent  
 Helix Angle: 21°

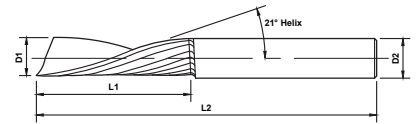

## 901-2, 901-4, 901-6 Metric



OD	LOC	SHK	OAL	Soft Plastic - Solid Surface	Hard Plastic - Solid Surface	General Wood
D1	L1	D2	L2	Part ID	Part ID	Part ID
2	6	2	50	-	-	901-602
	6	6	64	-	-	901-604
	8	6	64	901-204	-	-
2.5	6	2.5	50	-	-	901-606
	6	6	64	-	-	901-608
	8	2.5	50	901-206	-	-
	8	6	64	901-208	901-408	-
3	8	3	50	901-210	901-410	901-610
	8	6	64	901-212	901-412	901-612
	12	3	64	901-214	901-414	901-614
	12	6	64	901-216	901-416	901-616
4	8	4	64	901-218	901-418	901-618
	12	4	64	901-220	901-420	901-620
	20	4	64	901-222	901-422	901-622
	20	6	64	901-224	901-424	901-624
	30	4	64	901-226	901-426	901-626
5	16	5	64	901-228	901-428	901-628
	16	6	64	901-230	901-430	901-630
	30	5	64	901-232	901-432	901-632
6	8	6	64	901-234	901-434	901-634
	12	6	64	901-236	901-436	901-636
	20	6	64	901-238	901-438	901-638
	30	6	76	901-240	901-440	901-640
	38	6	76	901-242	901-442	901-642
8	25	8	64	901-244	901-444	901-644
	38	8	76	901-246	901-446	901-646
10	30	10	76	901-248	901-448	901-648
	35	10	76	901-250	901-450	-

# Single Flute Upcut Spiral

## Endmill End

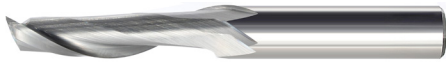

Finish-Top: Inferior  
 Finish-Bottom: Excellent  
 End Point Type: Endmill  
 Helix Angle: 30°

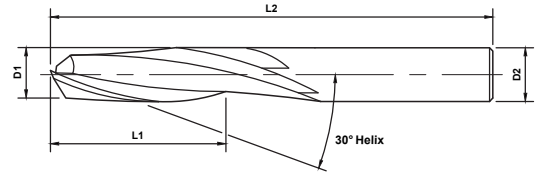

## 802-0, 802-3 Fractional



OD	LOC	SHK	OAL	Hard Plastic and Aluminum	Soft Plastic and Soft Wood
D1	L1	D2	L2	Part ID	Part ID
1/8	1/2	1/4	2	802-002	802-302
5/32	9/16	1/4	2	802-004	-
3/16	5/8	1/4	2	802-006	-
	3/4	1/4	2	802-024	802-304
1/4	5/8	1/4	2-1/2	802-008	-
	3/4	1/4	2-1/2	802-010	-
	7/8	1/4	2-1/2	-	802-306
	1	1/4	2-1/2	-	802-308
	1-1/4	1/4	3	802-022	-
9/32	3/4	3/8	2-1/2	802-012	-
5/16	13/16	3/8	2-1/2	802-014	-
	1-1/8	5/16	3	-	802-310
3/8	7/8	3/8	2-1/2	802-016	-
	1-1/8	3/8	3	-	802-312
7/16	1	1/2	3	802-018	-
1/2	1	1/2	3	802-020	-
	1-1/8	1/2	3	-	802-314

## 902-0 Metric



OD	LOC	SHK	OAL	Hard Plastic and Aluminum
D1	L1	D2	L2	Part ID
4	16	6	64	902-002
5	20	6	64	902-004
6	25	6	64	902-006
8	25	8	64	902-008



# Single Flute Downcut Spiral

## Endmill End



Finish-Top: Excellent  
 Finish-Bottom: Inferior  
 End Point Type: Endmill  
 Helix Angle: 30°

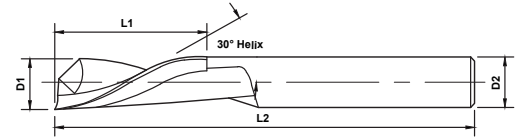

## 802-1, 802-4 Fractional



OD	LOC	SHK	OAL	Hard Plastic and Aluminum	Soft Plastic and Soft Wood
D1	L1	D2	L2	Part ID	Part ID
1/8	1/2	1/4	2	802-102	802-402
3/16	3/4	1/4	2	802-124	802-404
1/4	3/4	1/4	2-1/2	802-110	-
	7/8	1/4	2-1/2	-	802-406
	1	1/4	2-1/2	-	802-408
	1-1/4	1/4	3	802-122	-
5/16	13/16	3/8	2-1/2	802-114	-
	1-1/8	5/16	3	-	802-410
3/8	7/8	3/8	2-1/2	802-116	-
	1-1/8	3/8	3	-	802-412
1/2	1-1/8	1/2	3	-	802-414

## 902-1 Metric



OD	LOC	SHK	OAL	Hard Plastic and Aluminum
D1	L1	D2	L2	Part ID
4	16	6	64	902-102
5	20	6	64	902-104
6	25	6	64	902-106
8	25	8	64	902-108

# Single Flute Veining Bit

## Endmill End



Finish-Top: Inferior  
Finish-Bottom: Excellent  
End Point Type: Endmill  
Helix Angle: 10°

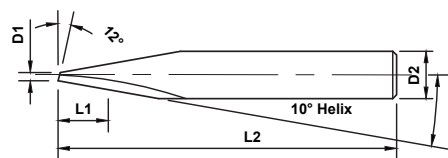

## 802-5 Fractional



OD	LOC	SHK	OAL	General Wood
D1	L1	D2	L2	Part ID
1/16	1/4	1/4	1-1/2	802-502
3/32	1/4	1/4	1-1/2	802-504
1/8	1/4	1/4	1-1/2	802-506

# Single Flute Compression Spiral

## Endmill End



Finish-Top: Excellent  
Finish-Bottom: Excellent  
End Point Type: Endmill  
Helix Angle: 30°

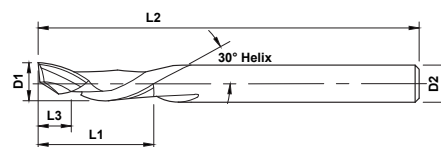

## 802-1, 802-4 Fractional



OD	LOC	Upcut	SHK	OAL	General Wood
D1	L1	L3	D2	L2	Part ID
1/8	3/8	0.17	1/4	2-1/2	802-602
3/16	5/8	0.28	1/4	2-1/2	802-604
1/4	7/8	0.39	1/4	2-1/2	802-606
3/8	1-1/8	0.50	3/8	3	802-608
	1-1/8	0.50	3/8	3	802-608L (Left Hand)
1/2	1	0.44	1/2	3	802-610
	1-1/8	.5	1/2	3	802-612
	1-3/8	.61	1/2	3-1/2	802-614
	1-5/8	.71	1/2	3-1/2	802-616
	1-5/8	.71	1/2	3-1/2	802-618 (Left Hand)
5/8	2-1/4	.99	5/8	4	802-620
3/4	2	.88	3/4	4	802-622

## 902-6 Metric



OD	LOC	Upcut	SHK	OAL	General Wood
D1	L1	L3	D2	L2	Part ID
6	25	11	6	64	902-602
8	25	11	8	64	902-604
10	35	15.4	10	76	902-606
12	35	15.4	12	76	902-608
16	55	24.2	16	100	902-610

# Single Flute Ball Compression Spiral

## Endmill End



Finish-Top: Excellent  
 Finish-Bottom: Excellent  
 End Point Type: Endmill  
 Helix Angle: 30°

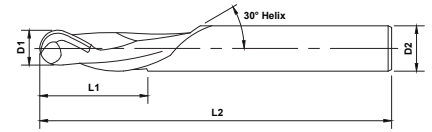

## 802-7 Fractional



OD	LOC	SHK	OAL	General Wood
D1	L1	D2	L2	Part ID
1/4	7/8	1/4	2-1/2	802-702
1/2	1-1/8	1/2	3	802-704

# Single Flute Mortise Compression

## Endmill End



Finish-Top: Excellent  
 Finish-Bottom: Excellent  
 End Point Type: Endmill  
 Helix Angle: 30°

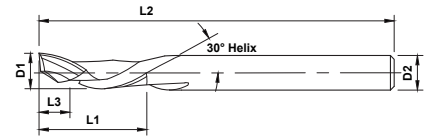

## 802-8 Fractional



OD	LOC	Mortise	SHK	OAL	General Wood
D1	L1	L3	D2	L2	Part ID
1/4	7/8	.175	1/4	2-1/2	802-802
3/8	7/8	.188	3/8	3	802-804
1/2	7/8	.200	1/2	3	802-806
	7/8	.200	1/2	3	802-808 (Left Hand)
	1-5/8	.200	1/2	3-1/2	802-810

## 902-8 Metric



OD	LOC	Mortise	SHK	OAL	General Wood
D1	L1	L3	D2	L2	Part ID
6	22	5	6	64	902-802
8	22	5	8	64	902-804
10	22	5	10	72	902-806
12	22	5	12	72	902-808

# Two Flute Straight Cut

## Endmill End



Finish-Top: Excellent  
Finish-Bottom: Excellent  
End Point Type: Endmill

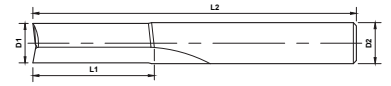

## 803-0, 803-2 Fractional



OD	LOC	SHK	OAL	General Wood	Hard Plastics
D1	L1	D2	L2	Part ID	
1/8	1/4	1/4	2	803-002	-
	1/2	1/4	2	-	803-202
5/32	9/16	1/4	2	-	803-204
	3/8	1/4	2	803-004	-
3/16	5/8	1/4	2	803-006	803-206
	5/8	1/4	2	803-008 (Left Hand)	-
	5/8	1/4	4	803-010	-
	5/8	1/4	4	-	-
7/32	5/8	1/4	2-1/2	-	803-208
	3/8	1/4	2-1/2	803-012	-
	3/4	1/4	2-1/2	803-014	803-210
	3/4	1/4	2-1/2	803-016 (Left Hand)	-
	3/4	1/4	3-1/4	-	803-212
9/32	1-1/4	1/4	4	803-018	-
	3/4	3/8	2-1/2	-	803-214
5/16	1-3/16	3/8	2-1/2	-	803-216
	5/8	3/8	2-1/2	803-020	-
3/8	7/8	3/8	2-1/2	803-022	803-218
	7/8	3/8	2-1/2	803-024 (Left Hand)	-
	1-5/8	3/8	6	803-026	-
	1-5/8	3/8	6	-	-
7/16	1	1/2	3	-	803-220
	1	1/2	3	803-028	803-222
1/2	1	1/2	3	803-030 (Left Hand)	-
	1	1/2	3	-	-

## 903-0 Metric



OD	LOC	SHK	OAL	General Wood
D1	L1	D2	L2	Part ID
4	16	6	64	903-002
5	20	6	64	903-004
6	25	6	64	903-006
8	25	8	76	903-008
10	35	10	88	903-010
12	35	12	88	903-012

# Two Flute Straight Cut

## Plunge Fishtail End



Finish-Top: Excellent  
Finish-Bottom: Excellent  
End Point Type: Plunge (Fishtail)

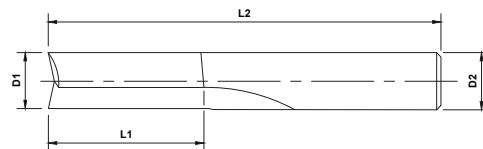

## 803-1 Fractional



OD	LOC	SHK	OAL	Soft Wood and Hard Plastic
D1	L1	D2	L2	Part ID
1/8	1/2	1/4	2	803-102
5/32	5/8	1/4	2	803-104
3/16	3/4	1/4	2	803-106
7/32	3/4	1/4	2-1/2	803-108
1/4	7/8	1/4	2-1/2	803-110
	1	1/4	2-1/2	803-114
	1-1/8	1/4	3	803-116
9/32	1	5/16	2-1/2	803-118
5/16	1-1/8	5/16	3	803-120
	1-1/8	1/2	3	803-122
3/8	1-1/8	3/8	3	803-124
	1-1/4	3/8	3	803-126
	1-1/4	1/2	3	803-128
7/16	1	1/2	3	803-130
1/2	1-1/8	1/2	3	803-132
	1-1/4	1/2	3-1/2	803-134
	1-5/8	1/2	3-1/2	803-136
17/32	1-1/8	1/2	3	803-138
5/8	2-1/8	5/8	4	803-140
3/4	1-5/8	3/4	4	803-142

## 903-1 Metric



OD	LOC	SHK	OAL	Soft Wood and Hard Plastic
D1	L1	D2	L2	Part ID
4	16	6	64	903-102
5	20	6	64	903-104
6	25	6	64	903-106
8	25	8	64	903-108
10	35	10	76	903-110
12	35	12	76	903-112

# Two Flute Straight 'V' Flute

## Edge Rounding



Designed for rounding the edge of sheets or parts.

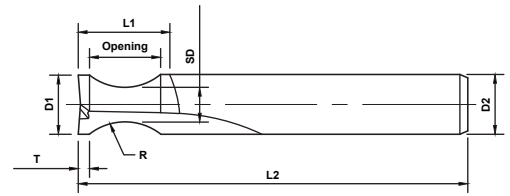

## 803-4 Fractional



OD	LOC	SHK	OAL		Radius	Small Diameter	Tip to Radius	Soft Plastics, HardPlastics, General Wood
D1	L1	D2	L2	Opening	R	SD	T	Part ID
3/8	3/8	3/8	2-1/2	5/32	1/8	.320	1/16	803-402
	3/8	3/8	2-1/2	7/32	3/16	.305	1/16	803-404
	3/8	3/8	2-1/2	9/32	1/4	.288	1/16	803-406
	1/2	3/8	2-1/2	13/32	3/8	.255	1/16	803-408
1/2	3/8	1/2	3	5/32	1/8	.445	1/16	803-410
	3/8	1/2	3	7/32	3/16	.430	1/16	803-412
	3/8	1/2	3	9/32	1/4	.413	1/16	803-414
	5/8	1/2	3	17/32	1/2	.347	1/16	803-416

## 903-4 Metric



OD	LOC	SHK	OAL		Radius	Small Diameter	Tip to Radius	Soft Plastics, HardPlastics, General Wood
D1	L1	D2	L2	Opening	R	SD	T	Part ID
8	12	8	64	9	8	5.21	1.5	903-402
10	14	10	70	11	10	6.68	1.5	903-404
12	16	12	76	13	12	8.18	1.5	903-406

# Two Flute Shear 'V' Bottom

90° Point

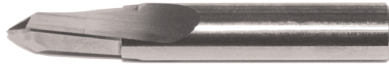

Finish-Top: Excellent  
Finish-Bottom: Excellent  
End Point Type: 90° Point

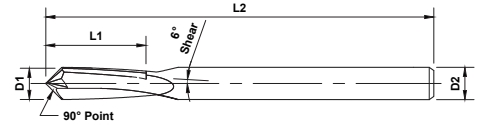

## 803-1 Fractional



OD	LOC	SHK	OAL	General Wood
D1	L1	D2	L2	Part ID
3/16	5/8	1/4	2	803-502
1/4	3/4	1/4	2	803-504
3/8	3/4	3/8	2-1/2	803-506

# Two Flute 'O' Flute Straight Cut

Edge Rounding



Designed for rounding the edge of sheets or parts

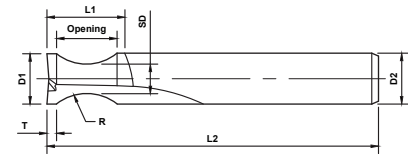

## 803-6 Fractional



OD	LOC	SHK	OAL	Radius	Small Diameter	Tip to Radius	Soft Plastic, Hard Plastic, General Wood
D1	L1	D2	L2	Opening	R	SD	Part ID
	3/8	1/4	2-1/2	5/32	1/8	.195	803-602
1/4	3/8	1/4	2-1/2	7/32	3/16	.180	803-604
	3/8	1/4	2-1/2	9/32	1/4	.163	803-606

## 903-6 Metric



OD	LOC	SHK	OAL	Radius	Small Diameter	Tip to Radius	Soft Plastic, Hard Plastic, General Wood
D1	L1	D2	L2	Opening	R	SD	Part ID
	10	6	64	4	3	4.47	903-602
6	10	6	64	6	5	3.96	903-606
	10	6	64	7.25	6.35	3.73	903-608



# Two Flute 'O' Flute Straight Cut

## Fishtail End



Finish-Top: Excellent  
Finish-Bottom: Excellent  
End Point Type: Fishtail

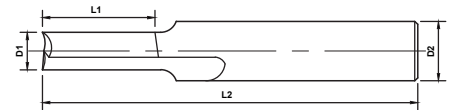

## 803-7, 803-8 Fractional



OD	LOC	SHK	OAL	Soft Plastics	Hard Plastic
D1	L1	D2	L2	Part ID	
1/8	1/4	1/4	2	-	803-802
	5/16	1/4	2	803-702	-
	1/2	1/4	2	803-704	-
	5/8	1/4	4	803-706	-
3/16	3/8	1/4	2	803-708	803-804
	5/8	1/4	2	803-710	803-806
	5/8	1/4	2	-	803-808 (Left Hand)
	5/8	1/4	4	-	803-810
	1	1/4	4	803-712	-
1/4	3/8	1/4	2-1/2	803-714	803-812
	3/4	1/4	2-1/2	-	803-814
	3/4	1/4	2-1/2	-	803-816 (Left Hand)
	1	1/4	2-1/2	803-716	-
	1	1/4	2-1/2	803-718 (Left Hand)	-
	1	1/4	3-1/4	803-720	-
	1-1/4	1/4	4	803-722	803-818
3/8	5/8	3/8	2-1/2	-	803-820
	7/8	3/8	2-1/2	803-724	803-822
	7/8	3/8	2-1/2	-	803-824 (Left Hand)
	1	3/8	4	803-726	-
	1-5/8	3/8	6	-	803-826
1/2	1	1/2	3	803-728	803-828
	1	1/2	3	-	803-830 (Left Hand)
	1	1/2	4	803-730	-
	1-3/4	1/2	4	803-732	-
	2-1/8	1/2	6	803-734	803-832

## 903-7 Metric



OD	LOC	SHK	OAL	Soft Plastics
D1	L1	D2	L2	Part ID
4	16	6	64	903-702
5	20	6	64	903-704
6	25	6	64	903-706
8	25	8	76	903-708
10	35	10	88	903-710
12	35	12	88	903-712

# Two Flute Upcut Spiral

## Plunge/Fishtail End

### 804-0 Fractional



OD	LOC	SHK	OAL	General Wood
D1	L1	D2	L2	Part ID
1/8	1/2	1/4	2	804-006
	1/2	1/4	2	804-008 (Left Hand)
5/32	5/8	1/4	2	804-010
	1/2	1/4	2-1/2	804-012
3/16	3/4	3/16	2	804-014
	3/4	1/4	2	804-016
	3/4	1/4	2	804-018 (Left Hand)
	3/4	1/4	2-1/2	804-020
7/32	3/4	1/4	2-1/2	804-022
	1	1/4	2-1/2	804-024
1/4	7/8	1/4	2-1/2	804-026
	1	1/4	2-1/2	804-028
	1	1/4	2-1/2	804-030 (Left Hand)
	1-1/8	1/4	3	804-032
9/32	1	5/16	2-1/2	804-034
	1	5/16	2-1/2	804-036
	1-1/8	5/16	3	804-038
	1-1/4	5/16	3	804-040
	1-1/8	1/2	3	804-042
	1-1/8	1/2	3	804-044 (Left Hand)
5/16	1-3/4	5/16	4	804-046
	1	3/8	2-1/2	804-048
	1	3/8	3	804-050
	1-1/8	3/8	3	804-052
	1-1/4	3/8	3	804-054
	1-1/4	3/8	3	804-056 (Left Hand)
7/16	1-1/4	1/2	3	804-058
	1	1/2	3	804-060
	1-1/8	1/2	3	804-062
	1-1/4	1/2	3-1/2	804-064
1/2	1-5/8	1/2	3-1/2	804-066
	1-5/8	1/2	3-1/2	804-068 (Left Hand)
	2-1/8	1/2	4	804-070
	17/32	1/2	3	804-072
5/8	1-5/8	5/8	3-1/2	804-074
	2-1/8	5/8	4	804-076
	2-1/8	5/8	4	804-078 (Left Hand)
3/4	1-5/8	3/4	4	804-080
	2-1/8	3/4	4	804-082
	2-1/8	3/4	4	804-084 (Left Hand)
1	3	1	5	804-086



Finish-Top: Inferior  
 Finish-Bottom: Excellent  
 End Point Type: Plunge (Fishtail)  
 Helix Angle: 30°

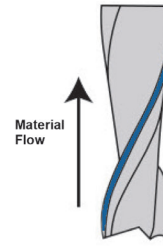
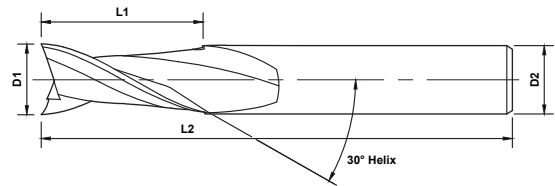

**Upcut**  
 Good Bottom Finish

Right hand spiral.  
 Right hand cut.  
 Pulls material toward spindle.

### 904-0 Metric



OD	LOC	SHK	OAL	General Wood
D1	L1	D2	L2	Part ID
4	16	6	64	904-002
5	20	6	64	904-004
6	25	6	64	904-006
8	25	8	64	904-008
10	35	10	76	904-010
12	35	12	76	904-012
14	50	14	88	904-014
16	55	16	100	904-016
18	60	18	120	904-018
20	60	20	120	904-020

# Two Flute Downcut Spiral

## Plunge/Fishtail End

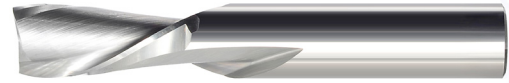

### 804-2 Fractional



OD	LOC	SHK	OAL	General Wood
D1	L1	D2	L2	Part ID
3/32	9/32	1/8	1-1/2	804-202
1/8	1/2	1/8	2	804-204
	1/2	1/4	2	804-206
	1/2	1/4	2	804-208 (Left Hand)
5/32	5/8	1/4	2	804-210
	1/2	1/4	2-1/2	804-212
3/16	3/4	3/16	2	804-214
	3/4	1/4	2	804-216
	3/4	1/4	2	804-218 (Left Hand)
	3/4	1/4	2-1/2	804-220
7/32	3/4	1/4	2-1/2	804-222
	1	1/4	2-1/2	804-224
1/4	7/8	1/4	2-1/2	804-226
	1	1/4	2-1/2	804-228
	1	1/4	2-1/2	804-230 (Left Hand)
	1-1/8	1/4	3	804-232
9/32	1	5/16	2-1/2	804-234
5/16	1	5/16	2-1/2	804-236
	1-1/8	5/16	3	804-238
	1-1/4	5/16	3	804-240
	1-1/8	1/2	3	804-242
	1-1/8	1/2	3	804-244 (Left Hand)
	1-3/4	5/16	4	804-246
3/8	1	3/8	2-1/2	804-248
	1	3/8	3	804-250
	1-1/8	3/8	3	804-252
	1-1/4	3/8	3	804-254
	1-1/4	3/8	3	804-256 (Left Hand)
	1-1/4	1/2	3	804-258
7/16	1	1/2	3	804-260
1/2	1-1/8	1/2	3	804-262
	1-1/4	1/2	3-1/2	804-264
	1-5/8	1/2	3-1/2	804-266
	1-5/8	1/2	3-1/2	804-268 (Left Hand)
	2-1/8	1/2	4	804-270
17/32	1-1/8	1/2	3	804-272
5/8	1-5/8	5/8	3-1/2	804-274
	2-1/8	5/8	4	804-276
	2-1/8	5/8	4	804-278 (Left Hand)
3/4	1-5/8	3/4	4	804-280
	2-1/8	3/4	4	804-282
	2-1/8	3/4	4	804-284 (Left Hand)
1	3	1	6	804-286

Finish-Top: Excellent  
Finish-Bottom: Inferior  
End Point Type: Fishtail  
Helix Angle: 30°

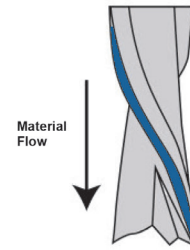
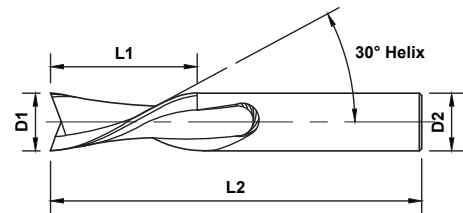

**Downcut**  
Good Top Finish  
Left hand spiral.  
Right hand cut.  
Pushes material away from spindle.

### 904-2 Metric



OD	LOC	SHK	OAL	General Wood
D1	L1	D2	L2	Part ID
4	16	6	64	904-202
5	20	6	64	904-204
6	25	6	64	904-206
8	25	8	64	904-208
10	35	10	76	904-210
12	35	12	76	904-212
14	50	14	88	904-214
16	55	16	100	904-216
18	60	18	120	904-218
20	60	20	120	904-220

# Two Flute Upcut Spiral

## Endmill End



Finish-Top: Inferior  
 Finish-Bottom: Excellent  
 End Point Type: Endmill  
 Helix Angle: 30°

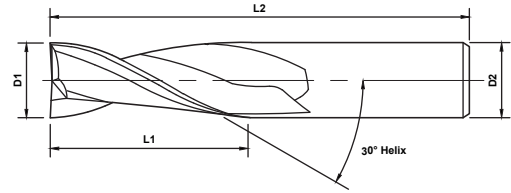

## 805-0 Fractional



OD	LOC	SHK	OAL	Hard Plastics and Aluminum
D1	L1	D2	L2	Part ID
1/8	1/2	1/4	2	805-002
5/32	9/16	1/4	2	805-004
3/16	5/8	1/4	2	805-006
	5/8	1/4	2	805-008 (Left Hand)
7/32	5/8	1/4	2-1/2	805-010
1/4	3/4	1/4	2-1/2	805-012
	3/4	1/4	2-1/2	805-014 (Left Hand)
9/32	3/4	3/8	2-1/2	805-016
5/16	13/16	3/8	2-1/2	805-018
3/8	7/8	3/8	2-1/2	805-020
7/16	1	1/2	3	805-022
1/2	1	1/2	3	805-024

## 905-0 Metric



OD	LOC	SHK	OAL	Hard Plastic and Aluminum
D1	L1	D2	L2	Part ID
3	12	3	50	905-002
4	12	4	50	905-012
5	17	5	50	905-004
6	17	6	60	905-014
8	32	8	70	905-006
10	32	10	70	905-008
	42	10	100	905-010
12	32	12	80	905-016

# Two Flute Downcut Spiral

## Endmill End



Finish-Top: Excellent  
 Finish-Bottom: Inferior  
 End Point Type: Endmill  
 Helix Angle: 30°

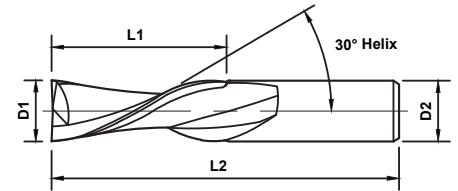

## 805-1 Fractional



OD	LOC	SHK	OAL	Hard Plastics and Aluminum
D1	L1	D2	L2	Part ID
1/8	1/2	1/4	2	805-102
5/32	9/16	1/4	2	805-104
3/16	5/8	1/4	2	805-106
	5/8	1/4	2	805-108 (Left Hand)
7/32	5/8	1/4	2-1/2	805-110
1/4	3/4	1/4	2-1/2	805-112
	3/4	1/4	2-1/2	805-114 (Left Hand)
9/32	3/4	3/8	2-1/2	805-116
5/16	13/16	3/8	2-1/2	805-118
3/8	7/8	3/8	2-1/2	805-120
7/16	1	1/2	3	805-122
1/2	1	1/2	3	805-124

## 905-1 Metric



OD	LOC	SHK	OAL	Hard Plastics and Aluminum
D1	L1	D2	L2	Part ID
3	12	3	50	905-102
4	12	4	50	905-112
5	17	5	50	905-104
6	17	6	60	905-114
8	32	8	70	905-106
10	32	10	70	905-108
	42	10	100	905-110
12	32	12	80	905-116

# High Impact Two Flute Upcut Spiral

## Fishtail End



Finish-Top: Inferior  
 Finish-Bottom: Excellent  
 End Point Type: Fishtail  
 Helix Angle: 30°

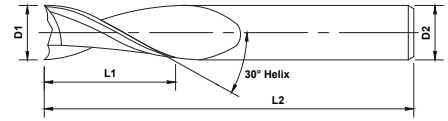

## 804-8 Fractional



OD	LOC	SHK	OAL	General Wood
D1	L1	D2	L2	Part ID
1/4	7/8	1/4	2-1/2	804-802
3/8	7/8	3/8	3	804-804
	1-1/8	3/8	3	804-806
1/2	1-1/4	3/8	3	804-808
	1-1/4	1/2	3	804-810

# High Impact Two Flute Downcut Spiral

## Fishtail End

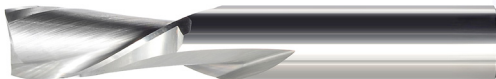

Finish-Top: Excellent  
 Finish-Bottom: Inferior  
 End Point Type: Fishtail  
 Helix Angle: 30°

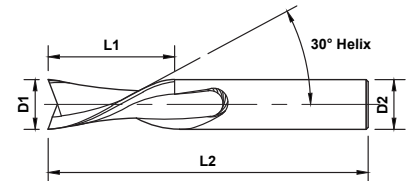

## 804-9 Fractional



OD	LOC	SHK	OAL	General Wood
D1	L1	D2	L2	Part ID
1/4	7/8	1/4	2-1/2	804-902
3/8	7/8	3/8	3	804-904
	1-1/8	3/8	3	804-906
1/2	1-1/4	3/8	3	804-908
	1-1/4	1/2	3	804-910

# Two Flute 'O' Flute Upcut Slow Sprial

## Endmill End



Finish-Top: Inferior  
 Finish-Bottom: Good  
 End Point Type: Endmill  
 Helix Angle: 11°

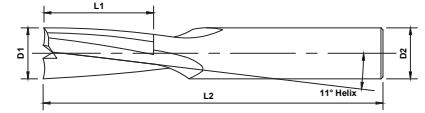

## 806-0 Fractional



OD	LOC	SHK	OAL	Hard Plastics and Aluminum
D1	L1	D2	L2	Part ID
1/4	3/8	1/4	2-1/2	806-002
	3/4	1/4	2-1/2	806-004
3/8	1	3/8	3	806-006
1/2	1-1/8	1/2	3-1/2	806-008

## 906-0 Metric



OD	LOC	SHK	OAL	Hard Plastic and Aluminum
D1	L1	D2	L2	Part ID
6	25	6	64	906-002
8	25	8	76	906-004
10	25	10	76	906-006
12	35	12	88	906-008

# Two Flute 'O' Flute Downcut Slow Spiral

## Endmill End



Finish-Top: Good  
 Finish-Bottom: Inferior  
 End Point Type: Endmill  
 Helix Angle: 11°

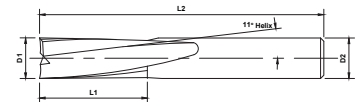

## 806-1 Fractional



OD	LOC	SHK	OAL	Hard Plastics and Aluminum
D1	L1	D2	L2	Part ID
1/4	3/8	1/4	2-1/2	806-102
	3/4	1/4	2-1/2	806-104
3/8	1	3/8	3	806-106
1/2	1-1/8	1/2	3-1/2	806-108

## 906-0 Metric



OD	LOC	SHK	OAL	Hard Plastics and Aluminum
D1	L1	D2	L2	Part ID
6	25	6	64	906-102
8	25	8	76	906-104
10	25	10	76	906-106
12	35	12	88	906-108

# Two Flute Upcut Slow Helix

## Endmill End



Finish-Top: Inferior  
 Finish-Bottom: Excellent  
 End Point Type: Endmill  
 Helix Angle: 15°

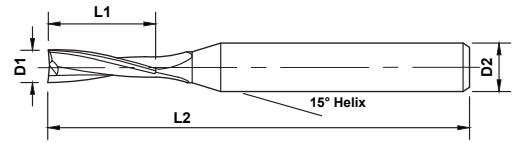

## 807-0 Fractional



OD	LOC	SHK	OAL	General Wood
D1	L1	D2	L2	Part ID
1/8	1/2	1/4	2	807-002
5/32	5/8	1/4	2-1/2	807-004
3/16	5/8	1/4	2	807-006
7/32	1	1/4	2-1/2	807-008
1/4	3/4	1/4	2-1/2	807-010
	1	1/4	2-1/2	807-012
	1-1/8	1/4	3	807-014
9/32	1	5/16	2-1/2	807-016
5/16	1-1/8	1/2	3	807-018
3/8	1	3/8	2-1/2	807-020
	1-1/4	1/2	3	807-022
	1-1/4	3/8	3	807-024
1/2	1-1/4	1/2	3	807-026
	1-5/8	1/2	3-1/2	807-028



# Two Flute Downcut Slow Helix

## Fishtail End



Finish-Top: Excellent  
 Finish-Bottom: Inferior  
 End Point Type: Fishtail  
 Helix Angle: 15°

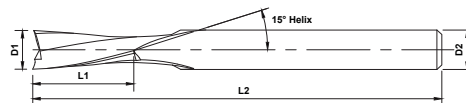

## 807-1 Fractional



OD	LOC	SHK	OAL	General Wood
D1	L1	D2	L2	Part ID
1/8	1/2	1/4	2	807-102
5/32	5/8	1/4	2-1/2	807-104
3/16	5/8	1/4	2	807-106
7/32	1	1/4	2-1/2	807-108
1/4	3/4	1/4	2-1/2	807-110
	1	1/4	2-1/2	807-112
	1-1/8	1/4	3	807-114
9/32	1	5/16	2-1/2	807-116
5/16	1-1/8	1/2	3	807-118
3/8	1	3/8	2-1/2	807-120
	1-1/4	1/2	3	807-122
	1-1/4	3/8	3	807-124
1/2	1-1/4	1/2	3	807-126
	1-5/8	1/2	3-1/2	807-128

# Two Flute Upcut Spiral Chipbreaker

## Endmill End

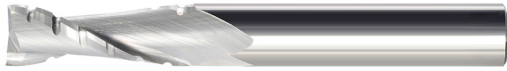

Finish-Top: Inferior  
 Finish-Mid: Excellent  
 Finish-Bottom: Excellent  
 End Point Type: Endmill  
 Helix Angle: 30°

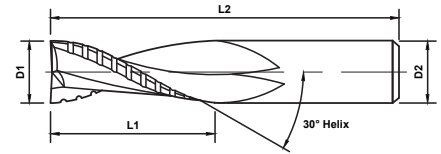

## 809-0 Fractional



OD	LOC	SHK	OAL	General Wood
D1	L1	D2	L2	Part ID
3/8	1-1/8	3/8	3	809-002
1/2	1-1/8	1/2	3	809-004
	1-5/8	1/2	3-1/2	809-006
	1-7/8	1/2	3-1/2	809-008
	2-1/8	1/2	4	809-010
5/8	2-1/8	5/8	4	809-012
3/4	2-1/8	3/4	4	809-014

## 909-0 Metric



OD	LOC	SHK	OAL	General Wood
D1	L1	D2	L2	Part ID
8	25	8	64	909-002
10	35	10	76	909-004
12	35	12	76	909-006
16	55	16	100	909-008
18	60	18	120	909-010

# Two Flute Downcut Spiral Chipbreaker

## Endmill End

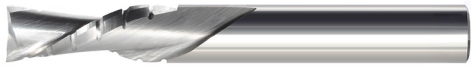

Finish-Top: Good  
 Finish-Mid: Excellent  
 Finish-Bottom: Inferior  
 End Point Type: Endmill  
 Helix Angle: 30°

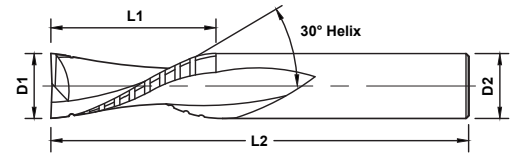

## 809-1 Fractional



OD	LOC	SHK	OAL	General Wood
D1	L1	D2	L2	Part ID
3/8	1-1/8	3/8	3	809-102
1/2	1-1/8	1/2	3	809-104
	1-5/8	1/2	3-1/2	809-106
	1-7/8	1/2	3-1/2	809-108
	2-1/8	1/2	4	809-110
5/8	2-1/8	5/8	4	809-112
3/4	2-1/8	3/4	4	809-114

## 909-1 Metric



OD	LOC	SHK	OAL	General Wood
D1	L1	D2	L2	Part ID
8	25	8	64	909-102
10	35	10	76	909-104
12	35	12	76	909-106
16	55	16	100	909-108
18	60	18	120	909-110

# High Impact Two Flute Upcut Spiral Chipbreaker

## Endmill End



Finish-Top: Inferior  
 Finish-Mid: Excellent  
 Finish-Bottom: Excellent  
 End Point Type: Endmill  
 Helix Angle: 30°

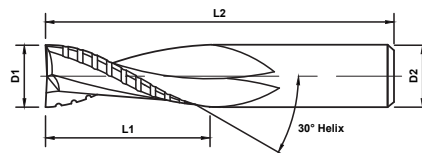

## 809-2 Fractional



OD	LOC	SHK	OAL	General Wood
D1	L1	D2	L2	Part ID
3/8	1-1/8	3/8	3	809-202
1/2	1-1/8	1/2	3	809-204
	1-5/8	1/2	3-1/2	809-206
	2-1/8	1/2	4	809-208

# High Impact Two Flute Downcut Spiral Chipbreaker

## Endmill End



Finish-Top: Good  
 Finish-Mid: Excellent  
 Finish-Bottom: Inferior  
 End Point Type: Endmill  
 Helix Angle: 30°

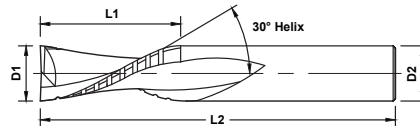

## 809-3 Fractional



OD	LOC	SHK	OAL	General Wood
D1	L1	D2	L2	Part ID
3/8	1-1/8	3/8	3	809-302
1/2	1-1/8	1/2	3	809-304
	1-5/8	1/2	3-1/2	809-306
	2-1/8	1/2	4	809-308

# Two Flute Compression

## Endmill End



Finish-Top: Excellent  
 Finish-Bottom: Excellent  
 End Point: Endmill  
 Helix Angle: 30°

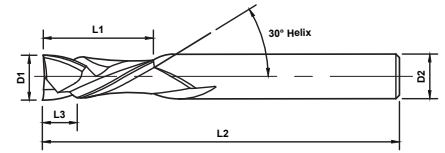

## 810-0 Fractional



OD	LOC	UPCUT	SHK	OAL	General Wood
D1	L1	L3	D2	L2	Part ID
1/4	7/8	.275	1/4	2-1/2	810-030
	7/8	.385	1/4	2-1/2	810-020
3/8	1	.3543	1/2	3	810-034
	1	.440	1/2	3	810-024
	1-1/8	.495	3/8	3	810-002
	1-1/8	.495	1/2	3	810-026
	1-1/4	.55	3/8	3	810-032
1/2	1	.44	1/2	3	810-004
	1-1/8	.495	1/2	3	810-006
	1-5/16	.578	1/2	3	810-022
	1-3/8	.605	1/2	3-1/2	810-008
	1-5/8	.715	1/2	3-1/2	810-028
	1-5/8	.715	1/2	4	810-010
	1-5/8	.715	1/2	4	810-012 (Left Hand)
5/8	2-1/4	.99	5/8	5	810-014
3/4	1-7/8	.825	3/4	4	810-016
	2-1/2	1.1	3/4	5	810-018

## 910-0 Metric



OD	LOC	UPCUT	SHK	OAL	General Wood
D1	L1	L3	D2	L2	Part ID
6	25	11	6	64	910-002
8	25	11	8	64	910-004
10	35	15.4	10	76	910-006
12	35	15.4	12	76	910-008
20	50	22	20	100	910-010

# Two Flute Mortise Compression

## Endmill End



Finish-Top: Excellent  
 Finish-Bottom: Excellent  
 End Point: Endmill  
 Helix Angle: 30°

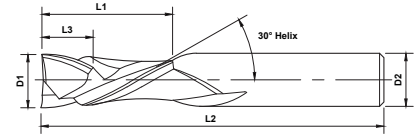

## 810-2 Fractional



OD	LOC	Mortise	SHK	OAL	General Wood
D1	L1	L3	D2	L2	Part ID
1/4	7/8	.188	1/4	2-1/2	810-202
3/8	7/8	.188	3/8	3	810-204
	1-1/8	.188	3/8	3	810-210
	1-1/8	.188	3/8	3	810-212 (Left Hand)
1/2	7/8	.200	1/2	3	810-206
	1-3/8	.200	1/2	3-1/2	810-208
	1-1/4	.250	1/2	3	810-214

## 910-2 Metric



OD	LOC	Mortise	SHK	OAL	General Wood
D1	L1	L3	D2	L2	Part ID
10	22	5	10	76	910-202
12	22	5	12	76	910-204

# Two Flute Chipbreaker Compression

## Endmill End

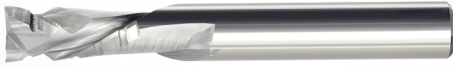

Finish-Top: Excellent  
 Finish-Mid: Excellent  
 Finish-Bottom: Excellent  
 End Point: Endmill  
 Helix Angle: 30°

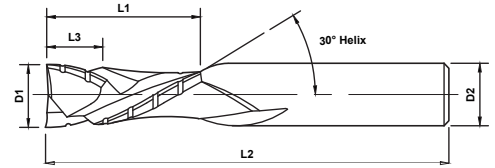

## 810-3 Fractional



OD	LOC	UPCUT	SHK	OAL	General Wood
D1	L1	L3	D2	L2	Part ID
3/8	7/8	0.385	3/8	3	810-302
	1-1/8	0.495	3/8	3	810-304
1/2	7/8	0.385	1/2	3	810-318
	1	0.44	1/2	3	810-306
	1-1/8	0.495	1/2	3	810-308
	1-3/8	0.605	1/2	3-1/2	810-310
	1-5/8	0.715	1/2	4	810-312
5/8	2-1/4	0.99	5/8	5	810-314
3/4	1-7/8	0.825	3/4	4	810-316

## 910-3 Metric



OD	LOC	UPCUT	SHK	OAL	General Wood
D1	L1	L3	D2	L2	Part ID
8	25	11.0	8	64	910-302
10	35	15.4	10	76	910-304
12	35	15.4	12	76	910-306
20	50	22.0	20	100	910-308

# Two Flute Ball Round Bottom

3° Slow Helix, Ball End



Finish-Top: Excellent  
Finish-Bottom: Excellent  
End Point: Ball  
Helix Angle: 3°

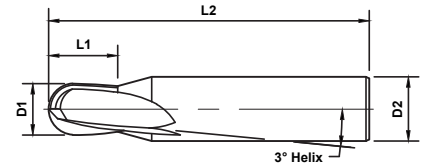

## 811-0 Fractional



OD	LOC	SHK	OAL	General Wood
D1	L1	D2	L2	Part ID
1/8	3/8	1/4	2	811-002
3/16	5/8	1/4	2	811-004
1/4	3/4	1/4	2	811-006
3/8	3/4	3/8	2-1/4	811-008

# Two Flute Straight Rout and Chamfer

Endmill End



Designed to provide up to a 1/16" top face chamfer and a finished side edge on plastic sheets or parts

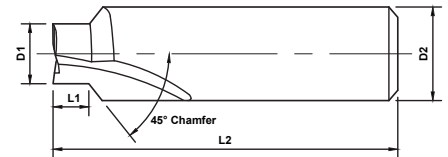

## 811-1 Fractional



OD	LOC	SHK	OAL	Soft and Hard Plastic
D1	L1	D2	L2	Part ID
1/4	3/16	3/8	2-1/4	811-102
	1/4	3/8	2-1/4	811-106
	5/16	3/8	2-1/4	811-110
3/8	3/16	1/2	3	811-104
	1/4	1/2	3	811-108
	5/16	1/2	3	811-112



# Two Flute Bottom Surface Corner Radius Upcut

## Endmill End



Finish-Top: Inferior  
 Finish-Bottom: Excellent  
 End Point: Endmill  
 Helix Angle: 30°

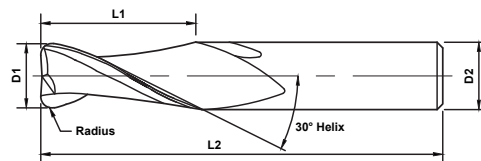

## 811-2 Fractional



OD	LOC	SHK	OAL	Radius	General Wood
D1	L1	D2	L2	R	Part ID
1/8	1/4	1/8	2	.040	811-202
	1/4	1/4	2	.040	811-204
1/4	3/8	1/4	2	.040	811-206
3/8	5/8	3/8	2-1/2	.050	811-208
1/2	7/8	1/2	3	.050	811-210

## 911-2 Metric



OD	LOC	SHK	OAL	Radius	General Wood
D1	L1	D2	L2	R	Part ID
3	6	3	40	1.00	911-202
	6	6	51	1.00	911-204
6	10	6	51	1.25	911-206
8	12	8	64	1.25	911-208
12	20	12	76	1.25	911-210

# Three Flute Straight Flute

## Endmill End



Finish-Top: Excellent  
 Finish-Bottom: Excellent  
 End Point: Endmill

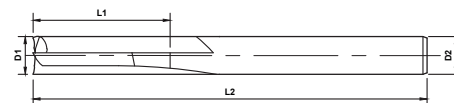

## 812-0 Fractional



OD	LOC	SHK	OAL	General Wood
D1	L1	D2	L2	Part ID
1/8	1/2	1/4	2	812-002
1/4	3/4	1/4	2-1/2	812-004

# Three Flute Upcut Spiral

## Endmill End



Finish-Top: Inferior  
 Finish-Bottom: Excellent  
 End Point: Endmill  
 Helix Angle: 30°

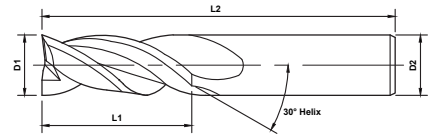

## 813-0 Fractional



OD	LOC	SHK	OAL	General Wood and Hard Plastics
D1	L1	D2	L2	Part ID
1/8	1/2	1/4	2	813-002
3/16	5/8	1/4	2	813-004
1/4	3/4	1/4	2-1/2	813-006
3/8	1-1/4	3/8	3	813-008
1/2	1-1/2	1/2	3-1/2	813-010
	2	1/2	4	813-012
5/8	2	5/8	4	813-014

## 913-0 Metric



OD	LOC	SHK	OAL	General Wood and Hard Plastics
D1	L1	D2	L2	Part ID
6	25	6	76	913-002
8	25	8	76	913-004
10	35	10	76	913-006
12	35	12	88	913-008
16	55	16	120	913-010
18	60	18	120	913-012

# Three Flute Downcut Spiral

## Endmill End



Finish-Top: Excellent  
 Finish-Bottom: Inferior  
 End Point: Endmill  
 Helix Angle: 30°

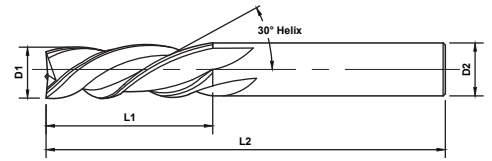

## 813-1 Fractional



OD	LOC	SHK	OAL	General Wood and Hard Plastics
D1	L1	D2	L2	Part ID
1/8	1/2	1/4	2	813-102
3/16	5/8	1/4	2	813-104
1/4	3/4	1/4	2-1/2	813-106
3/8	1-1/4	3/8	3	813-108
1/2	1-1/2	1/2	3-1/2	813-110
	2	1/2	4	813-112
5/8	2	5/8	4	813-114

## 913-1 Metric



OD	LOC	SHK	OAL	General Wood and Hard Plastic
D1	L1	D2	L2	Part ID
3	12	6	64	913-114
5	16	6	64	913-116
6	19	6	76	913-118
	25	6	76	913-102
8	25	8	76	913-104
10	35	10	76	913-106
12	35	12	88	913-108
16	55	16	120	913-110
18	60	18	120	913-112

# Three Flute Upcut Slow Spiral

## Endmill End



Finish-Top: Inferior  
 Finish-Bottom: Excellent  
 End Point: Endmill  
 Helix Angle: 10°

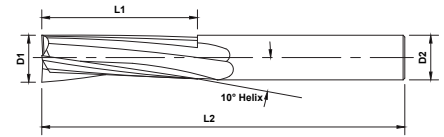

## 813-1 Fractional



OD	LOC	SHK	OAL	Soft Plastics and Hard Plastics
D1	L1	D2	L2	Part ID
1/4	3/8	1/4	3	814-002
	7/8	1/4	3	814-004
3/8	5/8	3/8	3	814-006
	1-1/8	3/8	3	814-008
1/2	1-1/8	1/2	3-1/2	814-010
	1-5/8	1/2	4	814-012
	2-1/8	1/2	4-1/2	814-014
3/4	1-5/8	3/4	4	814-016
	2-1/8	3/4	5	814-018

## 914-0 Metric



OD	LOC	SHK	OAL	Soft Plastics and Hard Plastics
D1	L1	D2	L2	Part ID
6	25	6	76	914-002
8	25	8	76	914-004
10	35	10	76	914-006
12	35	12	88	914-008
14	45	14	110	914-010
16	55	16	120	914-012
18	60	18	120	914-014

# Three Flute Downcut Slow Spiral

## Endmill End

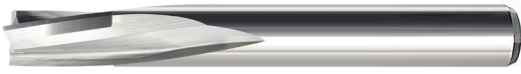

Finish-Top: Excellent  
 Finish-Bottom: Inferior  
 End Point: Endmill  
 Helix Angle: 10°

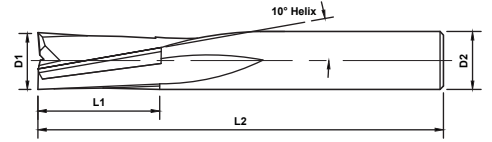

## 814-1 Fractional



OD	LOC	SHK	OAL	Soft Plastics and Hard Plastics
D1	L1	D2	L2	Part ID
1/4	3/8	1/4	3	814-102
	7/8	1/4	3	814-104
3/8	5/8	3/8	3	814-106
	1-1/8	3/8	3	814-108
1/2	1-1/8	1/2	3-1/2	814-110
	1-5/8	1/2	4	814-112
	2-1/8	1/2	4-1/2	814-114
3/4	1-5/8	3/4	4	814-116
	2-1/8	3/4	5	814-118

## 914-1 Metric



OD	LOC	SHK	OAL	Soft Plastics and Hard Plastics
D1	L1	D2	L2	Part ID
6	25	6	76	914-102
8	25	8	76	914-104
10	35	10	76	914-106
12	35	12	88	914-108
14	45	14	110	914-110
16	55	16	120	914-112
18	60	18	120	914-114

# Three Flute Upcut Slow Helix Ripper

## Endmill End



Finish-Top: Inferior  
 Finish-Mid: Inferior  
 Finish-Bottom: Inferior  
 End Point: Endmill  
 Helix Angle: 10°

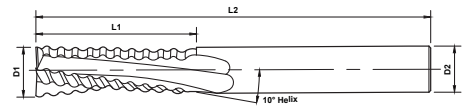

## 815-0 Fractional



OD	LOC	SHK	OAL	Soft Plastic, Hard Plastic and General Wood
D1	L1	D2	L2	Part ID
3/8	1-1/8	3/8	3-1/2	815-002
1/2	1-1/8	1/2	3-1/2	815-004
	1-5/8	1/2	4	815-006
5/8	1-5/8	5/8	4	815-008
	2-1/8	5/8	5	815-010
3/4	1-5/8	3/4	4	815-012
	2-1/8	3/4	5	815-014

## 914-0 Metric



OD	LOC	SHK	OAL	Soft Plastic, Hard Plastic and General Wood
D1	L1	D2	L2	Part ID
12	25	12	76	915-002
16	55	16	120	915-004
18	60	18	120	915-006

# Three Flute Downcut Slow Helix Ripper

## Endmill End



Finish-Top: Moderate  
 Finish-Mid: Inferior  
 Finish-Bottom: Inferior  
 End Point: Endmill  
 Helix Angle: 10°

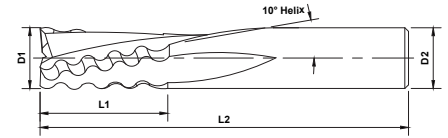

## 815-1 Fractional



OD	LOC	SHK	OAL	Soft Plastic, Hard Plastic and General Wood
D1	L1	D2	L2	Part ID
3/8	1-1/8	3/8	3-1/2	815-102
1/2	1-1/8	1/2	3-1/2	815-104
	1-5/8	1/2	4	815-106
5/8	1-5/8	5/8	4	815-108
	2-1/8	5/8	5	815-110
3/4	1-5/8	3/4	4	815-112
	2-1/8	3/4	5	815-114

## 914-0 Metric



OD	LOC	SHK	OAL	Soft Plastic, Hard Plastic and General Wood
D1	L1	D2	L2	Part ID
12	25	12	76	915-102
18	60	18	120	915-106

# Three Flute Upcut High Helix Ripper

## Endmill End



Finish-Top: Inferior  
 Finish-Mid: Inferior  
 Finish-Bottom: Moderate  
 End Point: Endmill  
 Helix Angle: 30°

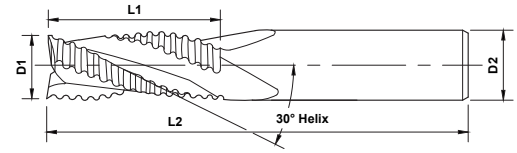

## 815-2 Fractional



OD	LOC	SHK	OAL	Soft Plastics, Hard Plastics and General Wood
D1	L1	D2	L2	Part ID
3/8	1-1/8	3/8	3-1/2	815-202
1/2	1-1/8	1/2	3-1/2	815-204
	1-5/8	1/2	4	815-206
5/8	1-5/8	5/8	4	815-208
	2-1/2	5/8	5	815-210
3/4	1-5/8	3/4	4	815-212

## 915-2 Metric



OD	LOC	SHK	OAL	Soft Plastic, Hard Plastic and General Wood
D1	L1	D2	L2	Part ID
16	55	16	120	915-204



# Three Flute Downcut High Helix Ripper

## Endmill End

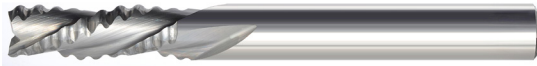

Finish-Top: Moderate  
 Finish-Mid: Inferior  
 Finish-Bottom: Inferior  
 End Point: Endmill  
 Helix Angle: 30°

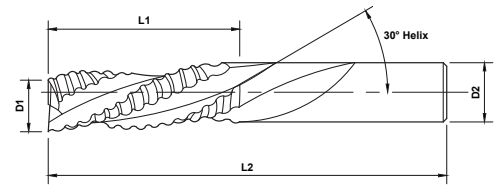

## 815-3 Fractional



OD	LOC	SHK	OAL	Soft Plastics, Hard Plastics and General Wood
D1	L1	D2	L2	Part ID
3/8	1-1/8	3/8	3-1/2	815-302
1/2	1-1/8	1/2	3-1/2	815-304
	1-5/8	1/2	4	815-306
5/8	1-5/8	5/8	4	815-308
	2-1/8	5/8	5	815-310
3/4	1-5/8	3/4	4	815-312
	2-1/8	3/4	5	815-314

## 915-3 Metric



OD	LOC	SHK	OAL	Soft Plastic, Hard Plastic and General Wood
D1	L1	D2	L2	Part ID
12	25	12	76	915-302
16	55	16	120	915-304
18	60	18	120	915-306

# High Impact Three Flute Upcut Spiral Ripper

## Endmill End



Finish-Top: Inferior  
 Finish-Mid: Inferior  
 Finish-Bottom: Excellent  
 End Point: Endmill  
 Helix Angle: 30°

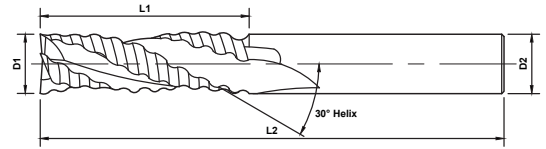

## 815-4 Fractional



OD	LOC	SHK	OAL	Soft Plastics, Hard Plastics and General Wood
D1	L1	D2	L2	Part ID
3/8	1-1/8	3/8	3	815-402
	1-1/8	1/2	3	815-404
1/2	1-5/8	1/2	3-1/2	815-406
	2-1/8	1/2	4	815-408

# High Impact Three Flute Downcut Spiral Ripper

## Endmill End



Finish-Top: Good  
 Finish-Mid: Inferior  
 Finish-Bottom: Inferior  
 End Point: Endmill  
 Helix Angle: 30°

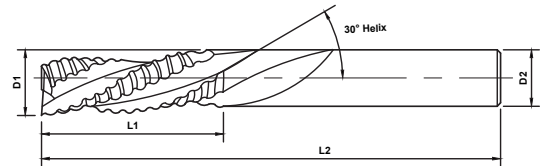

## 815-5 Fractional



OD	LOC	SHK	OAL	Soft Plastics, Hard Plastics and General Wood
D1	L1	D2	L2	Part ID
3/8	1-1/8	3/8	3	815-502
	1-1/8	1/2	3	815-504
1/2	1-5/8	1/2	3-1/2	815-506
	2-1/8	1/2	4	815-508

# Three Flute Upcut Lock Mortise

## Endmill End



Finish-Top: Excellent  
 Finish-Mid: Inferior  
 Finish-Bottom: Excellent  
 End Point: Endmill  
 Helix Angle: 30°

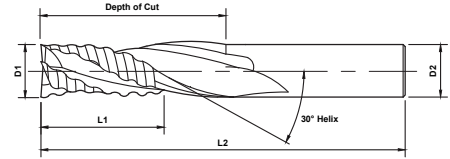

## 815-6 Fractional



OD	LOC	Depth of Cut	SHK	OAL	General Wood
D1	L1		D2	L2	Part ID
5/8	2	4-1/2	5/8	6-1/2	815-602

## 915-6 Metric



OD	LOC	Depth of Cut	SHK	OAL	General Wood
D1	L1		D2	L2	Part ID
16	50	114	16	170	915-602

# Three Flute Upcut Spiral Chipbreaker Finisher

## Endmill End



Finish-Top: Inferior  
 Finish-Mid: Superior  
 Finish-Bottom: Excellent  
 End Point: Endmill  
 Helix Angle: 30°

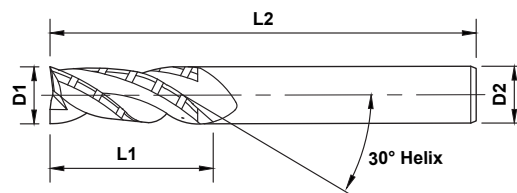

## 816-1 Fractional



OD	LOC	SHK	OAL	General Wood
D1	L1	D2	L2	Part ID
3/8	1-1/8	3/8	3	816-102
1/2	1-1/8	1/2	3	816-104
	1-3/8	1/2	3-1/2	816-106
	1-5/8	1/2	3-1/2	816-108
5/8	1-5/8	5/8	4	816-110
	1-5/8	3/4	4	816-112
	2-1/4	3/4	4	816-114
3/4	3-1/8	3/4	6	816-116

## 916-1 Metric



OD	LOC	SHK	OAL	General Wood
D1	L1	D2	L2	Part ID
8	25	8	64	916-102
10	35	10	76	916-104
12	35	12	76	916-106
16	55	16	100	916-108
18	60	18	120	916-110

# Three Flute Downcut Spiral Chipbreaker Finisher

## Endmill End

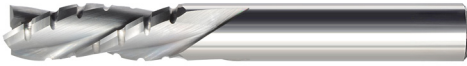

Finish-Top: Excellent  
 Finish-Mid: Superior  
 Finish-Bottom: Inferior  
 End Point: Endmill  
 Helix Angle: 30°

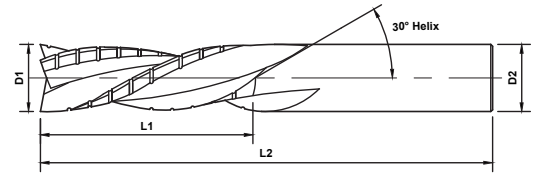

## 816-2 Fractional



OD	LOC	SHK	OAL	General Wood
D1	L1	D2	L2	Part ID
3/8	1-1/8	3/8	3	816-202
1/2	1-1/8	1/2	3	816-204
	1-3/8	1/2	3-1/2	816-206
	1-5/8	1/2	3-1/2	816-208
5/8	1-5/8	5/8	4	816-210
3/4	1-5/8	3/4	4	816-212
	2-1/4	3/4	5	816-214
	3-1/8	3/4	6	816-216

## 916-1 Metric



OD	LOC	SHK	OAL	General Wood
D1	L1	D2	L2	Part ID
8	25	8	64	916-202
10	35	10	76	916-204
12	35	12	76	916-206
16	55	16	100	916-208
18	60	18	120	916-210

# Three Flute Upcut Phenolic

## Endmill End



Finish-Top: Inferior  
 Finish-Mid: Superior  
 Finish-Bottom: Excellent  
 End Point: Endmill  
 Helix Angle: 10°

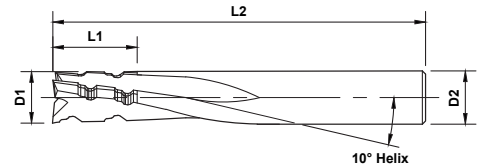

## 817-0 Fractional



OD	LOC	SHK	OAL	Hard Plastics, Phenolic, Composites and Laminates
D1	L1	D2	L2	Part ID
3/8	7/8	3/8	3	817-002
1/2	1-1/4	1/2	3-1/2	817-004
	2-1/8	1/2	4	817-006

# Three Flute Downcut Phenolic

## Endmill End



Finish-Top: Excellent  
 Finish-Mid: Superior  
 Finish-Bottom: Inferior  
 End Point: Endmill  
 Helix Angle: 10°

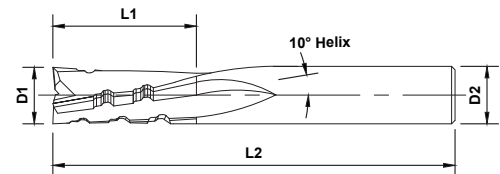

## 817-1 Fractional



OD	LOC	SHK	OAL	Hard Plastics, Phenolic, Composites and Laminates
D1	L1	D2	L2	Part ID
3/8	7/8	3/8	3	817-102
1/2	1-1/4	1/2	3-1/2	817-104
	2-1/8	1/2	4	817-106

# Three Flute Compression

## Endmill End



Finish-Top: Excellent  
 Finish-Bottom: Excellent  
 End Point: Endmill  
 Helix Angle: 30°

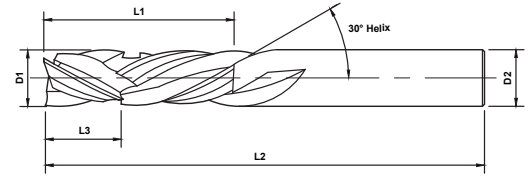

## 818-0 Fractional



OD	LOC	UPCUT	SHK	OAL	General Wood
D1	L1	L3	D2	L2	Part ID
3/8	1-1/8	0.50	3/8	3	818-002
1/2	1-1/8	0.50	1/2	3	818-004
	1-5/8	0.72	1/2	3-1/2	818-006
3/4	2	0.88	3/4	4	818-008

## 918-0 Metric



OD	LOC	UPCUT	SHK	OAL	General Wood
D1	L1	L3	D2	L2	Part ID
6	25	11.0	6	64	918-002
8	25	11.0	8	64	918-004
10	35	15.4	10	76	918-006
12	35	15.4	12	76	918-008

# Three Flute Mortise Compression

## Endmill End



Finish-Top: Excellent  
 Finish-Bottom: Excellent  
 End Point: Endmill  
 Helix Angle: 30°

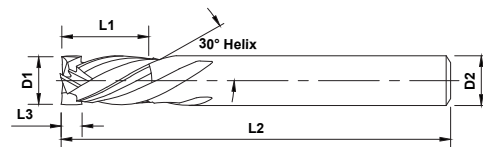

## 818-1 Fractional



OD	LOC	Mortise	SHK	OAL	General Wood
D1	L1	L3	D2	L2	Part ID
3/8	7/8	.200	3/8	3	818-202
1/2	7/8	.200	1/2	3	818-204
	1-3/8	.200	1/2	3-1/2	818-206
3/4	2	.200	3/4	4	818-208



# Four Flute Upcut Spiral

## Endmill End



Finish-Top: Inferior  
Finish-Bottom: Excellent  
End Point: Endmill  
Helix Angle: 30°

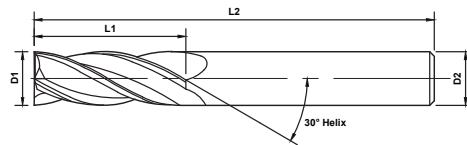

## 819-0, 819-2 Fractional



OD	LOC	SHK	OAL	Hard Plastic	Fiberglass
D1	L1	D2	L2	Part ID	Part ID
1/8	1/2	1/4	2	819-002	-
5/32	9/16	1/4	2	819-004	-
3/16	5/8	1/4	2	819-006	-
1/4	3/4	1/4	2-1/2	819-008	-
3/8	5/8	3/8	3	-	819-202
	1-1/8	3/8	3	-	819-204
1/2	5/8	1/2	3-1/2	-	819-206
	1-1/8	1/2	3-1/2	-	819-208

# Four Flute Downcut Spiral

## Endmill End



Finish-Top: Excellent  
Finish-Bottom: Inferior  
End Point: Endmill  
Helix Angle: 30°

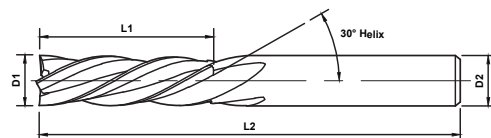

## 819-1, 819-3 Fractional



OD	LOC	SHK	OAL	Hard Plastic	Fiberglass
D1	L1	D2	L2	Part ID	Part ID
1/8	1/2	1/4	2	819-102	-
5/32	9/16	1/4	2	819-104	-
3/16	5/8	1/4	2	819-106	-
1/4	3/4	1/4	2-1/2	819-108	-
3/8	5/8	3/8	3	-	819-302
	1-1/8	3/8	3	-	819-304
1/2	5/8	1/2	3-1/2	-	819-306
	1-1/8	1/2	3-1/2	-	819-308

# High Velocity Four Flute Upcut Combination Spiral

## Endmill End



Finish-Top: Inferior  
 Finish-Mid: Inferior  
 Finish-Bottom: Excellent  
 End Point: Endmill  
 Helix Angle: 30°

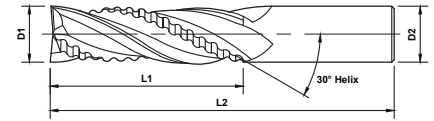

## 820-0 Fractional



OD	LOC	SHK	OAL	General Wood
D1	L1	D2	L2	Part ID
1/2	1-1/8	1/2	3-1/2	820-002
	1-5/8	1/2	4	820-004
	2-1/8	1/2	4-1/2	820-006
5/8	2-1/8	5/8	5	820-008
3/4	2-1/8	3/4	5	820-010

# High Velocity Four Flute Downcut Combination Spiral

## Endmill End



Finish-Top: Excellent  
 Finish-Mid: Inferior  
 Finish-Bottom: Inferior  
 End Point: Endmill  
 Helix Angle: 30°

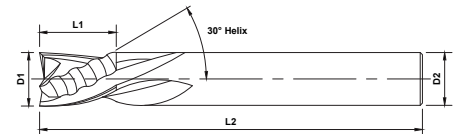

## 820-1 Fractional



OD	LOC	SHK	OAL	General Wood
D1	L1	D2	L2	Part ID
1/2	1-1/8	1/2	3-1/2	820-102
	1-5/8	1/2	4	820-104
	2-1/8	1/2	4-1/2	820-106
5/8	2-1/8	5/8	5	820-108
3/4	2-1/8	3/4	5	820-110

# Four Flute Compression

## Endmill End

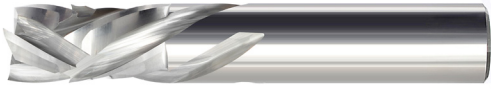

Finish-Top: Excellent  
 Finish-Bottom: Excellent  
 End Point: Endmill  
 Helix Angle: 30°

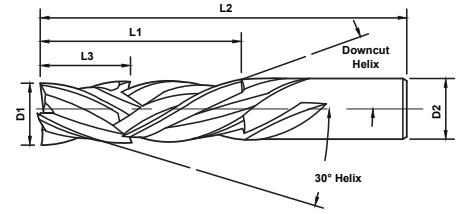

## 821-0 Fractional



OD	LOC	UPCUT	SHK	OAL	General Wood
D1	L1	L3	D2	L2	Part ID
1/2	1	0.44	1/2	3	821-002
1/2	1-1/8	0.50	1/2	3	821-004
1/2	1-3/8	0.61	1/2	3-1/2	821-006
1/2	1-5/8	0.72	1/2	4	821-008
5/8	2-1/4	0.99	5/8	5	821-010
3/4	1-7/8	0.83	3/4	4	821-012
3/4	2-1/2	0.55	3/4	5	821-014

# Four Flute Combination Compression

## Endmill End

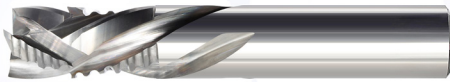

Finish-Top: Excellent  
 Finish-Mid: Inferior  
 Finish-Bottom: Excellent  
 End Point: Endmill  
 Helix Angle: 30°

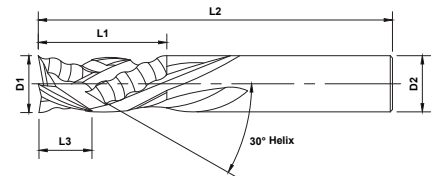

## 820-2 Fractional



OD	LOC	UPCUT	SHK	OAL	General Wood
D1	L1	L3	D2	L2	Part ID
1/2	1	0.44	1/2	3	820-202
1/2	1-1/8	0.50	1/2	3	820-204
1/2	1-3/8	0.61	1/2	3-1/2	820-206
1/2	1-5/8	0.72	1/2	4	820-208
5/8	2-1/4	0.99	5/8	5	820-210
3/4	1-7/8	0.83	3/4	4	820-212
3/4	2-1/2	0.55	3/4	5	820-214

# Four Flute Mortise Compression

## Endmill End

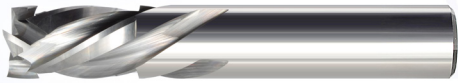

Finish-Top: Excellent  
 Finish-Bottom: Excellent  
 End Point: Endmill  
 Helix Angle: 30°

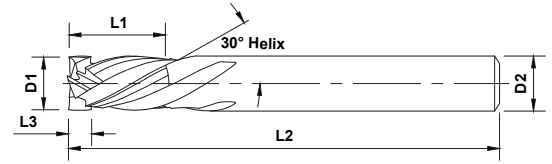

### 821-1 Fractional



OD	LOC	Mortise	SHK	OAL	General Wood
D1	L1	L3	D2	L2	Part ID
1/2	7/8	.200	1/2	3	821-102
	1-3/8	.200	1/2	3-1/2	821-104

# Laminate Trimmers

## Bevel Flush - Round End



Finish-Top: Good  
 Finish-Bottom: Good  
 End Point: Round  
 Bevel Flush & 7°

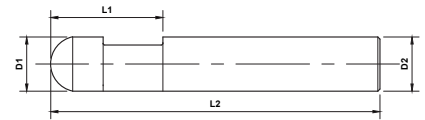

### 822-0 Fractional



OD	LOC	SHK	OAL	Composites and Laminates
D1	L1	D2	L2	Bevel
	3/8	1/4	1-1/2	Flush
1/4	1/4	1/4	1-1/2	Flush
	7/16	1/4	1-5/8	Flush

## 7° Bevel - Round End



Finish-Top: Good  
 Finish-Bottom: Good  
 End Point: Round  
 Bevel Flush & 7°

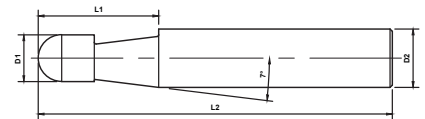

### 822-0 Fractional



OD	LOC	SHK	OAL	Composites and Laminates
D1	L1	D2	L2	Bevel
.200	1/4	1/4	1-1/2	7°
1/4	1/4	1/4	1-5/8	7°

# Aramid Router - Five Flute Upcut / Two Flute Downcut

## Endmill End



Finish-Top: Good  
 Finish-Bottom: Good  
 End Point: Endmill  
 Upcut Helix Angle: 20°  
 Downcut Helix Angle: 15°

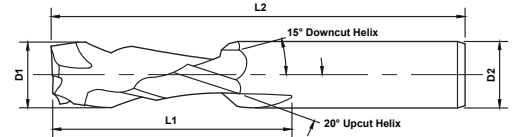

## 821-1 Fractional



OD	LOC	SHK	OAL	Fiberglass and Composites
D1	L1	D2	L2	Part ID
1/4	3/4	1/4	2-1/2	822-106
3/8	7/8	3/8	2-1/2	822-114
1/2	1	1/2	3	822-120

## Fiberglass Routers



Plain End, Series FGR-A



Burend, Series FGR-B      Millend, Series FGR-C      Drillend, Series FGR-D

- High Performance **A-Gr-SiV** submicron grain carbide
- Diamond cut flute pattern
- Effective on laminate and fiberglass materials
- MAP certified quality

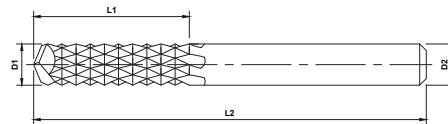

**For even greater performance, specify PowerN coating**

- High nano-hardness increases hardness 2.5 times
  - An outstanding heat and oxidation barrier
  - Ultra thin coating helps retain a super sharp edge
- Append -5 to the part number for PowerN**



	OD	LOC	SHK	OAL	End Cut Type			
K	D1	L1	D2	L2	Plain (A)	Burend (B)	Millend (C)	Drillend (D)
*	1/16	3/16	1/8	1-1/2	FGR1A	FGR1B	FGR1C	FGR1D
*	3/32	3/8	1/8	1-1/2	FGR1-1A	FGR1-1B	FGR1-1C	FGR1-1D
*	1/8	1/2	1/8	1-1/2	FGR2A	FGR2B	FGR2C	FGR2D
*	3/16	5/8	3/16	2	FGR3A	FGR3B	FGR3C	FGR3D
*	3/16	5/8	1/4	2	FGR4A	FGR4B	FGR4C	FGR4D
*	1/4	3/4	1/4	2	FGR5A	FGR5B	FGR5C	FGR5D
*	1/4	3/4	1/4	2-1/2	FGR6A	FGR6B	FGR6C	FGR6D
*	1/4	1	1/4	2-1/2	FGR6-0A	FGR6-0B	FGR6-0C	FGR6-0D
*	1/4	3/4	1/4	3	FGR6-1A	FGR6-1B	FGR6-1C	FGR6-1D
*	1/4	1	1/4	3	FGR6-2A	FGR6-2B	FGR6-2C	FGR6-2D
*	5/16	1	5/16	2-1/2	FGR7A	FGR7B	FGR7C	FGR7D
*	3/8	1	3/8	2-1/2	FGR8A	FGR8B	FGR8C	FGR8D
*	1/2	1	1/2	3	FGR9A	FGR9B	FGR9C	FGR9D

\* Solid Carbide

# Fluting Specifications

## Straight Flute vs. Spiral Routers

Straight flute routers are generally used for routing plastics and other soft materials. They are a great choice for hand feed operations. Spiral flute routers should only be used in automatic feed operations. They are good for use on all materials.

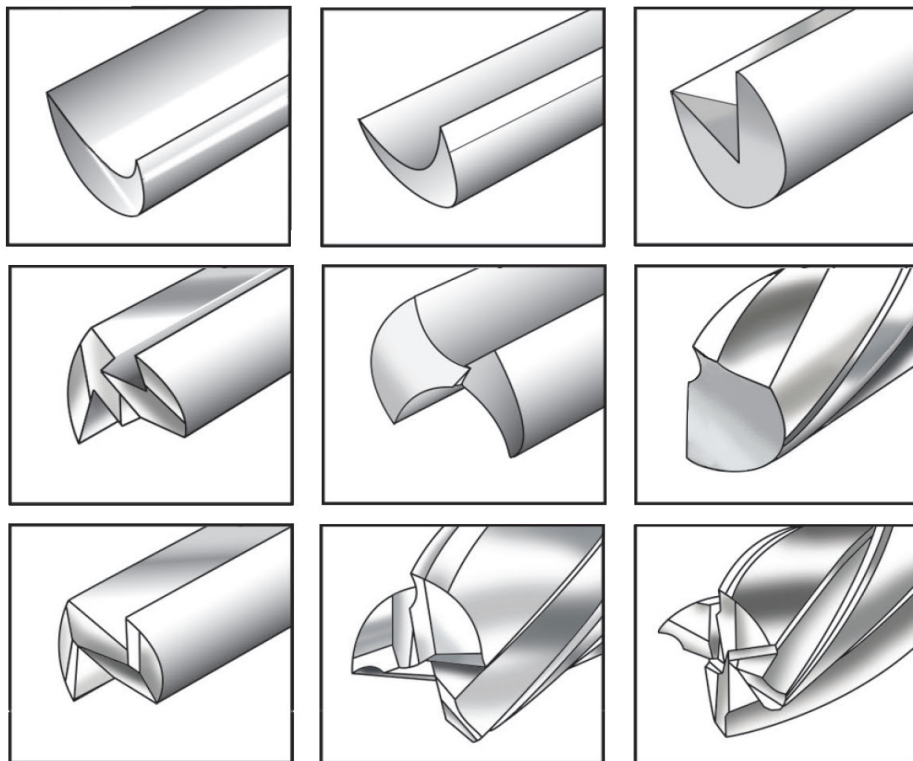

### Crescent End

Crescent end are typically found on 1 flute router bits. They are good for both plunging, and flat bottom cutting.

### Fishtail End

Fishtail, plunge end are the most commonly seen end points in the wood router industry. They are perfect when a rigid plunge point is required.

### Endmill End

Endmill end are most often found on 3 and 4 flute routers. They are good for achieving smooth finish on a flat bottom surface, and are commonly used in the plastic routing industry.

## Flute Features and Geometry

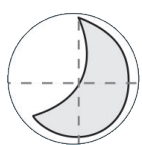

**1 Flute** routers are a good choice for soft materials. They provide a good finish, and are capable of faster feed rates.

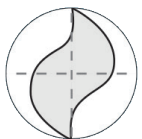

**2 Flute** routers work well with harder materials, providing an excellent finish to the material.

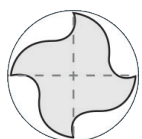

**Multi Flute** routers provide an excellent finish on the hardest of materials

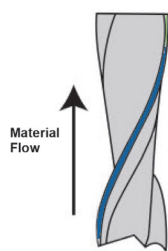

### Upcut

Good Bottom Finish

Right hand spiral. Right hand cut. Pulls material toward spindle.

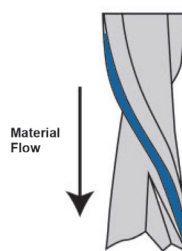

### Downcut

Good Top Finish

Left hand spiral. Right hand cut. Pushes material away from spindle.

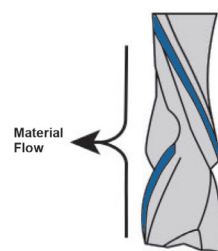

### Compression

Good Top and Bottom Finish

Neutralizes Push/Pull Forces

# Decimal-Metric Conversion Chart











Size	Decimal	MM
#81	0.013	0.33
#80	0.0135	0.343
#79	0.0145	0.368
1/64	0.0156	0.397
#78	0.016	0.406
#77	0.018	0.457
-	0.0197	0.5
#76	0.02	0.508
#75	0.021	0.533
#74	0.0225	0.572
#73	0.024	0.61
#72	0.025	0.635
#71	0.026	0.66
#70	0.028	0.711
#69	0.0292	0.742
#68	0.031	0.787
1/32	0.0313	0.794
#67	0.032	0.813
#66	0.033	0.838
#65	0.035	0.889
#64	0.036	0.914
#63	0.37	0.94
#62	0.038	0.965
#61	0.039	0.991
-	<b>0.0394</b>	<b>1</b>
#60	0.04	1.016
#59	0.041	1.041
#58	0.042	1.067
#57	0.043	1.092
#56	0.0465	1.181
3/64	0.0469	1.191
-	0.049	1.25
#55	0.052	1.321
#54	0.055	1.397
-	0.0591	1.5
#53	0.06	1.511
<b>1/16</b>	<b>0.0625</b>	<b>1.588</b>
#52	0.0635	1.613
#51	0.067	1.702
#50	0.07	1.778
#49	0.073	1.854
#48	0.076	1.93
5/64	0.0781	1.984
#47	0.0785	1.994
-	<b>0.0787</b>	<b>2</b>
#46	0.081	2.057
#45	0.082	2.082
#44	0.086	2.184
#43	0.089	2.261
#42	0.0935	2.375
3/32	0.0938	2.381
#41	0.096	2.438
#40	0.098	2.489
-	0.0984	2.5
#39	0.0995	2.527
#38	0.1015	2.578

Size	Decimal	MM
#37	0.104	2.641
#36	0.1065	2.705
7/64	0.1094	2.778
#35	0.11	2.794
#34	0.111	2.819
#33	0.113	2.87
#32	0.116	2.946
-	<b>0.1181</b>	<b>3</b>
#31	0.12	3.048
<b>1/8</b>	<b>0.125</b>	<b>3.175</b>
#30	0.1285	3.264
#29	0.136	3.454
-	0.1378	3.5
#28	0.1405	3.569
9/64	0.1406	3.572
#27	0.144	3.658
#26	0.147	3.734
#25	0.1495	3.797
#24	0.152	3.861
#23	0.154	3.911
5/32	0.1563	3.969
#22	0.157	3.988
-	<b>0.1575</b>	<b>4</b>
#21	0.159	4.039
#20	0.161	4.089
#19	0.166	4.216
#18	0.1695	4.305
11/64	0.1719	4.366
#17	0.173	4.394
#16	0.177	4.496
-	0.1772	4.5
#15	0.18	4.572
#14	0.182	4.623
#13	0.185	4.699
<b>3/16</b>	<b>0.1875</b>	<b>4.763</b>
#12	0.189	4.801
#11	0.191	4.851
#10	0.1935	4.915
#9	0.196	4.978
-	<b>0.1969</b>	<b>5</b>
#8	0.199	5.055
#7	0.201	5.105
13/64	0.2031	5.159
#6	0.204	5.182
#5	0.2055	5.22
#4	0.209	5.301
#3	0.213	5.41
-	0.2165	5.5
7/32	0.2188	5.556
#2	0.221	5.613
#1	0.228	5.791
#A	0.234	5.944
15/64	0.2344	5.953
-	<b>0.2362</b>	<b>6</b>
#B	0.238	6.045
#C	0.242	6.145











Size	Decimal	MM
#D	0.246	6.248
#E	0.25	6.35
<b>1/4</b>	<b>0.25</b>	<b>6.35</b>
-	0.2559	6.5
#F	0.257	6.528
#G	0.261	6.629
17/64	0.2656	6.747
-	0.266	6.749
#H	0.266	6.756
#I	0.272	6.909
-	<b>0.2756</b>	<b>7</b>
#J	0.277	7.036
#K	0.281	7.137
9/32	0.2813	7.144
#L	0.29	7.366
#M	0.295	7.493
-	0.2953	7.5
19/64	0.2969	7.541
#N	0.302	7.671
<b>5/16</b>	<b>0.3125</b>	<b>7.938</b>
-	<b>0.315</b>	<b>8</b>
#O	0.316	8.026
#P	0.323	8.204
21/64	0.3281	8.334
#Q	0.332	8.432
-	0.3346	8.5
#R	0.339	8.611
11/32	0.3438	8.731
#S	0.348	8.839
-	<b>0.3543</b>	<b>9</b>
#T	0.358	9.093
23/64	0.3594	9.128
#U	0.368	9.347
-	0.374	9.5
<b>3/8</b>	<b>0.375</b>	<b>9.525</b>
#V	0.377	9.576
#W	0.386	9.804
25/64	0.3906	9.922
-	<b>0.3937</b>	<b>10</b>
#X	0.397	10.084
#Y	0.404	10.262
13/32	0.4063	10.319
#Z	0.413	10.49
-	0.4134	10.5
27/64	0.4219	10.716
-	<b>0.4331</b>	<b>11</b>
<b>7/16</b>	<b>0.4375</b>	<b>11.113</b>
-	0.4528	11.5
29/64	0.4531	11.509
15/32	0.4688	11.906
-	<b>0.4724</b>	<b>12</b>
31/64	0.4844	12.303
<b>1/2</b>	<b>0.5</b>	<b>12.7</b>
-	<b>0.5118</b>	<b>13</b>
33/64	0.5156	13.097
17/32	0.5313	13.494

Size	Decimal	MM
-	0.5315	13.5
35/64	0.5469	13.891
-	<b>0.5512</b>	<b>14</b>
<b>9/16</b>	<b>0.5625</b>	<b>14.288</b>
-	0.5709	14.5
37/64	0.5781	14.684
-	<b>0.5906</b>	<b>15</b>
19/32	0.5938	15.081
39/64	0.6094	15.478
-	0.6102	15.5
<b>5/8</b>	<b>0.625</b>	<b>15.875</b>
-	<b>0.6299</b>	<b>16</b>
41/64	0.6406	16.272
-	0.6496	16.5
21/32	0.6563	16.669
-	<b>0.6693</b>	<b>17</b>
43/64	0.6719	17.066
<b>11/16</b>	<b>0.6875</b>	<b>17.463</b>
-	0.689	17.5
45/64	0.7031	17.859
-	<b>0.7087</b>	<b>18</b>
23/32	0.7188	18.256
-	0.7283	18.5
47/64	0.7344	18.653
-	<b>0.748</b>	<b>19</b>
<b>3/4</b>	<b>0.75</b>	<b>19.05</b>
49/64	0.7656	19.447
-	0.7677	19.5
25/32	0.7813	19.844
-	<b>0.7874</b>	<b>20</b>
51/64	0.7969	20.241
-	0.8071	20.5
<b>13/16</b>	<b>0.8125</b>	<b>20.638</b>
-	<b>0.8268</b>	<b>21</b>
53/64	0.8281	21.034
27/32	0.8438	21.431
-	0.8465	21.5
55/64	0.8594	21.828
-	<b>0.8661</b>	<b>22</b>
<b>7/8</b>	<b>0.875</b>	<b>22.225</b>
-	0.8858	22.5
57/64	0.8906	22.622
-	<b>0.9055</b>	<b>23</b>
29/32	0.9063	23.019
59/64	0.9219	23.416
-	0.9252	23.5
<b>15/16</b>	<b>0.9375</b>	<b>23.813</b>
-	<b>0.9449</b>	<b>24</b>
61/64	0.9531	24.209
-	0.9646	24.5
31/32	0.9688	24.606
-	<b>0.9843</b>	<b>25</b>
63/64	0.9844	25.003
<b>1</b>	<b>1</b>	<b>25.4</b>

# Technical Information for Routers - Softwood

									
Series	823-0, 823-1, 923-0, 923-1	802-3, 802-4	802-6, 802-8, 902-6, 902-8	802-9	800-0	804-0, 904-0	809-2, 809-3	810-0, 810-1, 810-2, 910-0, 910-2	803-1, 903-1
Page	8,9	19	20, 21	22	10	28	36, 37	37, 38	23
Diameter	1xD	1xD	1xD	1xD	1xD	1xD	1xD	1xD	1xD
1.5mm	0.03-0.08 mm								
1/16"	0.001-0.003"								
3mm	0.05-0.10 mm	0.05-0.11 mm	0.28-0.33 mm		0.20-0.25 mm	0.13-0.18 mm			0.10-0.15 mm
1/8"	0.002-0.004"	0.002-0.005"	0.011-0.013"		0.008-0.010"	0.005-0.007"			0.004-0.006"
6mm	0.10-0.15 mm	0.10-0.16 mm	0.38-0.43 mm		0.25-0.30 mm	0.18-0.23 mm		0.46-0.51 mm	0.015-0.19 mm
1/4"	0.004-0.006"	0.004-0.007"	0.015-0.017"		0.010-0.012"	0.007-0.009"		0.018-0.020"	0.006-0.008"
10mm	0.13-0.18 mm	0.13-0.19 mm	0.43-0.48 mm		0.28-0.33 mm	0.20-0.25 mm	0.60-0.66 mm	0.51-0.56 mm	0.18-0.23 mm
3/8"	0.005-0.007"	0.005-0.008"	0.017-0.019"		0.011-0.013"	0.008-0.010"	0.024-0.026"	0.020-0.022"	0.007-0.009"
12mm	0.18-0.23 mm	0.18-0.24 mm	0.48-0.53 mm	0.48-0.53 mm	0.31-0.36 mm	0.23-0.28 mm	0.66-0.71 mm	0.56-0.61 mm	0.19-0.25 mm
1/2"	0.007-0.009"	0.007-0.010"	0.019-0.021"	0.019-0.021"	0.012-0.014"	0.009-0.011"	0.026-0.028"	0.022-0.024"	0.008-0.010"
16mm			0.53-0.58 mm					0.61-0.66 mm	
5/8"			0.021-0.023"					0.024-0.026"	
20mm								0.66-0.71 mm	0.25-0.31 mm
3/4"								0.026-0.028"	0.010-0.012"

# Technical Information for Routers - Hardwood











									
Series	823-0, 823-1, 923-0, 923-1	802-3, 802-4	802-6, 802-8, 902-6, 902-8	802-9	800-0	804-0, 904-0	819-2, 819-3	810-0, 810-2, 910-0, 910-2	810-3
Page	8, 9	19	20, 21	22	10	28	52	37, 38	39
Diameter	1xD	1xD	1xD	1xD	1xD	1xD	1xD	1xD	1xD
1.5mm	0.03-0.08 mm								
1/16"	0.001-0.003"								
3mm	0.05-0.10 mm	0.05-0.11 mm	0.28-0.33 mm		0.20-0.25 mm				
1/8"	0.002-0.004"	0.002-0.005"	0.011-0.013"		0.008-0.010"				
6mm	0.10-0.15 mm	0.10-0.16 mm	0.38-0.43 mm		0.25-0.30 mm	0.12-0.17 mm		0.36-0.40 mm	
1/4"	0.004-0.006"	0.004-0.007"	0.015-0.017"		0.010-0.012"	0.005-0.007"		0.014-0.016"	
10mm	0.13-0.18 mm	0.13-0.19 mm	0.43-0.48 mm		0.28-0.33 mm	0.15-0.20 mm	0.48-0.53 mm	0.40-0.46 mm	0.48-0.53 mm
3/8"	0.005-0.007"	0.005-0.008"	0.017-0.019"		0.011-0.013"	0.006-0.008"	0.019-0.021"	0.016-0.018"	0.019-0.021"
12mm	0.18-0.23 mm	0.18-0.24 mm	0.48-0.53 mm	0.48-0.53 mm	0.31-0.36 mm	0.17-0.22 mm	0.53-0.58 mm	0.46-0.51 mm	0.53-0.58 mm
1/2"	0.007-0.009"	0.007-0.010"	0.019-0.021"	0.019-0.021"	0.012-0.014"	0.007-0.009"	0.021-0.023"	0.018-0.020"	0.021-0.023"
16mm			0.53-0.58 mm					0.51-0.56 mm	0.58-0.64 mm
5/8"			0.021-0.023"					0.020-0.022"	0.023-0.025"
20mm								0.56-0.61 mm	0.64-0.69 mm
3/4"								0.022-0.024"	0.025-0.027"

## SPEED AND FEED FORMULAS:









Depth of Cut:  
 1 x D Use suggested chip load. +2 x D Decrease chip load by 25%. +3 x D Decrease chip load by 50%.  
 Formula: RPM = Feed Rate / (Number of Flutes x Chip Load) • Feed Rate = RPM x Number of Flutes x Chip Load • Chip Load = Feed rate / (RPM x Number of Flutes)

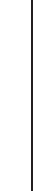

# Chip Load Specifications

										
803-5	813-0, 813-1, 913-0, 913-1	814-0, 914-0, 814-1, 914-1	815-0, 815-1, 915-0, 915-1	815-2, 915-2, 815-3	815-4, 815-5	815-6, 915-6	816-1, 816-2, 916-1, 916-2	818-0, 918-0, 818-1	820-0, 820-1, 820-2	821-0, 821-1
26	41, 42	42, 43	44	45	46	47	47, 48	47, 48	53, 54	54, 55
1/2xD	1xD	1xD	1xD	1xD	1xD	1xD	1xD	1xD	1xD	1xD
	0.20-0.25 mm									
	0.008-0.010"									
0.05-0.10 mm	0.25-0.30 mm	0.13-0.18 mm								
0.002-0.004"	0.010-0.012"	0.005-0.007"								
	0.30-0.36 mm	0.15-0.20 mm	0.33-0.38 mm	0.40-0.46 mm	0.43-0.48 mm		0.43-0.48 mm	0.48-0.53 mm		
	0.012-0.014"	0.006-0.008"	0.013-0.015"	0.016-0.018"	0.017-0.019"		0.017-0.019"	0.019-0.021"		
	0.36-0.40 mm	0.18-0.23 mm	0.38-0.43 mm	0.45-0.51 mm	0.45-0.51 mm		0.48-0.53 mm	0.53-0.58 mm	0.48-0.53 mm	0.38-0.43 mm
	0.014-0.016"	0.007-0.009"	0.015-0.017"	0.018-0.020"	0.018-0.020"		0.019-0.021"	0.021-0.023"	0.019-0.021"	0.015-0.017"
						0.13-0.18 mm			0.53-0.58 mm	0.43-0.48 mm
						0.005-0.007"			0.021-0.023"	0.017-0.019"
		0.20-0.25 mm	0.48-0.53 mm	0.55-0.61 mm			0.53-0.58 mm		0.58-0.64 mm	0.48-0.53 mm
		0.008-0.010"	0.019-0.021"	0.022-0.024"			0.021-0.023"		0.023-0.025"	0.019-0.021"











# Chip Load Specifications

								
803-1, 903-1	803-5	815-0, 815-1, 915-0, 915-1	815-2, 915-2, 815-3	815-4, 815-5	815-6, 915-6	818-0, 918-0, 818-1	820-0	821-0, 821-1
23	26	44	45	46	47	49, 50	53	54, 55
1xD	1xD	1xD	1xD	1xD	1xD	1xD	1xD	1xD
0.08-0.13 mm								
0.003-0.005"								
0.13-0.17 mm	0.05-0.10 mm							
0.005-0.007"	0.002-0.004"							
0.15-0.20 mm	0.05-0.10 mm	0.33-0.38 mm	0.38-0.43 mm	0.38-0.43 mm		0.48-0.53 mm		
0.006-0.008"	0.002-0.004"	0.013-0.015"	0.015-0.017"	0.015-0.017"		0.019-0.021"		
0.17-0.22 mm		0.36-0.40 mm	0.43-0.48 mm	0.38-0.43 mm		0.53-0.58 mm	0.45-0.50 mm	0.33-0.38 mm
0.007-0.009"		0.014-0.016"	0.017-0.019"	0.015-0.017"		0.021-0.023"	0.018-0.020"	0.013-0.015"
0.20-0.24 mm		0.40-0.46 mm	0.48-0.53 mm		0.12-0.17 mm		0.50-0.55 mm	0.38-0.43 mm
0.008-0.010"		0.016-0.018"	0.019-0.021"		0.005-0.007"		0.020-0.022"	0.015-0.017"
0.23-0.28 mm		0.43-0.48 mm	0.53-0.58 mm	0.48-0.53 mm		0.63-0.68 mm	0.55-0.60 mm	0.40-0.45 mm
0.009-0.011"		0.017-0.019"	0.021-0.023"	0.019-0.021"		0.025-0.027"	0.022-0.024"	0.016-0.018"

## SPEED AND FEED FORMULAS:

Depth of Cut:  
 1 x D Use suggested chip load. +2 x D Decrease chip load by 25%. +3 x D Decrease chip load by 50%.  
 Formula: RPM = Feed Rate / (Number of Flutes x Chip Load) • Feed Rate = RPM x Number of Flutes x Chip Load • Chip Load = Feed rate / (RPM x Number of Flutes)

# Technical Information for Routers - Medium Density Fiberboard

 <b>Medium Density Fiberboard</b>										
	Series	813-0, 813-1, 913-0, 913-1	802-3, 802-4	802-6, 802-8, 902-6, 902-8	802-9	800-0	804-0, 804-2	809-2, 809-3	810-0, 810-2, 910-0, 910-2	810-3
Page	41, 42	19	21	22	10	28, 29	36, 37	37, 38	39	23
Diameter	1xD	1xD	1xD	1xD	1xD	1xD	1xD	1xD	1xD	1xD
1.5mm	0.02-0.07 mm									
1/16"	0.001-0.003"									
3mm	0.05-0.10 mm	0.25-0.30 mm	0.25-0.30 mm		0.17-0.22 mm					0.07-0.12 mm
1/8"	0.002-0.004"	0.010-0.012"	0.010-0.012"		0.007-0.009"					0.003-0.005"
6mm	0.10-0.15 mm	0.30-0.35 mm	0.33-0.38 mm		0.22-0.27 mm	0.12-0.17 mm		0.33-0.38 mm		0.12-0.17 mm
1/4"	0.004-0.006"	0.012-0.014"	0.013-0.015"		0.009-0.011"	0.005-0.007"		0.013-0.015"		0.005-0.007"
10mm	0.12-0.17 mm	0.33-0.38 mm	0.35-0.40 mm		0.25-0.30 mm	0.15-0.20 mm	0.43-0.48 mm	0.35-0.40 mm	0.43-0.48 mm	0.15-0.20 mm
3/8"	0.005-0.007"	0.013-0.015"	0.014-0.016"		0.010-0.012"	0.006-0.008"	0.017-0.019"	0.014-0.016"	0.017-0.019"	0.006-0.008"
12mm		0.35-0.40 mm	0.40-0.45 mm	0.40-0.46 mm	0.27-0.33 mm	0.20-0.25 mm	0.45-0.50 mm	0.40-0.45 mm	0.45-0.50 mm	0.17-0.22 mm
1/2"		0.014-0.016"	0.016-0.018"	0.016-0.018"	0.011-0.013"	0.008-0.010"	0.018-0.020"	0.016-0.018"	0.018-0.020"	0.007-0.009"
16mm						0.25-0.30 mm	0.50-0.56 mm	0.45-0.50 mm	0.50-0.55 mm	
5/8"						0.010-0.012"	0.020-0.022"	0.018-0.020"	0.020-0.022"	
20mm						0.27-0.33 mm	0.58-0.63 mm	0.48-0.53 mm	0.58-0.63 mm	0.22-0.27 mm
3/4"						0.011-0.013"	0.023-0.025"	0.019-0.021"	0.023-0.025"	0.009-0.011"











# Technical Information for Routers - Soft Plywood

 <b>Soft Plywood</b>									
	Series	823-0, 823-1	802-6, 802-8, 902-6, 902-8	800-0	809-0, 809-1	809-2, 809-3	810-0, 810-1, 810-2, 910-0, 910-2	810-3	803-1, 903-1
Page	8, 9	20, 21	10	35, 36	36, 37	37, 38	39	23	26
Diameter	1xD	1xD	1xD	1xD	1xD	1xD	1xD	1xD	1xD
1.5mm	0.02-0.07 mm								
1/16"	0.001-0.003"								
3mm	0.05-0.10 mm	0.33-0.38 mm	0.15-0.20 mm					0.07-0.12 mm	
1/8"	0.002-0.004"	0.013-0.015"	0.006-0.008"					0.003-0.005"	
6mm	0.10-0.15 mm	0.38-0.43 mm	0.20-0.25 mm			0.43-0.48 mm		0.12-0.17 mm	0.05-0.10 mm
1/4"	0.004-0.006"	0.015-0.017"	0.008-0.010"			0.017-0.019"		0.005-0.007"	0.002-0.004"
10mm	0.12-0.17 mm	0.40-0.45 mm	0.22-0.27 mm	0.55-0.60 mm	0.55-0.60 mm	0.48-0.53 mm	0.55-0.60 mm	0.15-0.20 mm	0.05-0.10 mm
3/8"	0.005-0.007"	0.016-0.018"	0.009-0.011"	0.022-0.024"	0.022-0.024"	0.019-0.021"	0.022-0.024"	0.006-0.008"	0.002-0.004"
12mm		0.45-0.50 mm	0.25-0.30 mm	0.60-0.66 mm	0.60-0.66 mm	0.53-0.58 mm	0.60-0.66 mm	0.17-0.22 mm	0.07-0.12 mm
1/2"		0.018-0.020"	0.010-0.012"	0.024-0.026"	0.024-0.026"	0.021-0.023"	0.024-0.026"	0.007-0.009"	0.003-0.005"
16mm		0.50-0.55 mm		0.66-0.71 mm		0.58-0.63 mm	0.66-0.71 mm		
5/8"		0.020-0.022"		0.026-0.028"		0.023-0.025"	0.026-0.028"		
20mm		0.55-0.60 mm		0.71-0.76 mm		0.63-0.68 mm	0.71-0.76 mm	0.22-0.27 mm	0.10-0.15 mm
3/4"		0.022-0.024"		0.028-0.030"		0.025-0.027"	0.028-0.030"	0.009-0.011"	0.004-0.006"









## SPEED AND FEED FORMULAS:

Depth of Cut:  
 1 x D Use suggested chip load. +2 x D Decrease chip load by 25%. +3 x D Decrease chip load by 50%.  
 Formula: RPM = Feed Rate / (Number of Flutes x Chip Load) • Feed Rate = RPM x Number of Flutes x Chip Load • Chip Load = Feed rate / (RPM x Number of Flutes)

# Chip Load Specifications

									
803-5	814-0, 914-0, 814-1, 914-1	815-0, 815-1, 915-0, 915-1	815-2, 915-2, 815-3	815-4, 815-5	815-6, 915-6	816-1, 816-2, 916-1, 916-2	818-0, 918-0, 818-1	820-0, 820-1, 820-2	821-0, 821-1
26	41	42, 43	45	46	47	47, 48	47, 48	53, 54	54, 55
1/2xD	1xD	1xD	1xD	1xD	1xD	1xD	1xD	1xD	1xD
0.02-0.07 mm	0.10-0.15 mm								
0.001-0.003"	0.004-0.006"								
0.05-0.10 mm	0.12-0.17 mm	0.30-0.35 mm	0.43-0.48 mm	0.43-0.48 mm		0.35-0.40 mm	0.48-0.53 mm		
0.002-0.004"	0.005-0.007"	0.012-0.014"	0.017-0.019"	0.017-0.019"		0.014-0.016"	0.019-0.021"		
0.07-0.12 mm	0.12-0.17 mm	0.33-0.38 mm	0.45-0.50 mm	0.48-0.53 mm		0.40-0.45 mm	0.53-0.58 mm	0.50-0.55 mm	0.35-0.40 mm
0.003-0.005"	0.005-0.007"	0.013-0.015"	0.018-0.020"	0.019-0.021"		0.016-0.018"	0.021-0.023"	0.020-0.022"	0.014-0.016"
		0.35-0.40 mm	0.50-0.55 mm		0.10-0.15 mm	0.43-0.48 mm		0.55-0.60 mm	0.40-0.45 mm
		0.014-0.016"	0.020-0.022"		0.004-0.006"	0.017-0.019"		0.022-0.024"	0.016-0.018"
0.12-0.17 mm	0.15-0.20 mm	0.40-0.45 mm	0.58-0.63 mm			0.48-0.53 mm		0.60-0.66 mm	0.45-0.50 mm
0.005-0.007"	0.006-0.008"	0.016-0.018"	0.023-0.025"			0.019-0.021"		0.024-0.026"	0.018-0.020"

# Chip Load Specifications

							
815-0, 815-1, 915-0, 915-1	815-2, 915-2, 815-3	815-4, 815-5	815-6, 915-6	816-1, 816-2, 916-1, 916-2	818-0, 918-0, 818-1	820-0, 820-1, 820-2	821-0, 821-1
42	43	44	45	45, 46	47, 48	51, 52	54, 55
1xD	1xD	1xD	1xD	1xD	1xD	1xD	1xD
0.35-0.40 mm	0.43-0.48 mm	0.43-0.48 mm		0.50-0.55 mm	0.48-0.53 mm		
0.014-0.16"	0.017-0.019"	0.017-0.019"		0.020-0.022"	0.019-0.021"		
0.40-0.45 mm	0.48-0.53 mm	0.48-0.53 mm		0.55-0.60 mm	0.53-0.58 mm	0.71-0.76 mm	0.53-0.58 mm
0.016-0.018"	0.019-0.021"	0.019-0.021"		0.022-0.024"	0.021-0.023"	0.028-0.030"	0.021-0.023"
0.45-0.50	0.53-0.58 mm		0.07-0.12 mm	0.60-0.66 mm		0.76-0.81 mm	0.58-0.63 mm
0.018-0.020"	0.021-0.023"		0.003-0.005"	0.024-0.026"		0.030-0.032"	0.023-0.025"
0.50-0.55	0.58-0.63 mm			0.66-0.71 mm		0.81-0.86 mm	0.63-0.68 mm
0.020-0.022"	0.023-0.025"			0.026-0.028"		0.032-0.034"	0.025-0.027"

## SPEED AND FEED FORMULAS:

Depth of Cut:

1 x D Use suggested chip load. +2 x D Decrease chip load by 25%. +3 x D Decrease chip load by 50%.

Formula:  $RPM = \text{Feed Rate} / (\text{Number of Flutes} \times \text{Chip Load})$  •  $\text{Feed Rate} = RPM \times \text{Number of Flutes} \times \text{Chip Load}$  •  $\text{Chip Load} = \text{Feed rate} / (RPM \times \text{Number of Flutes})$

# Technical Information for Routers - Hard Plywood

									
Series	823-0, 823-1, 923-0, 923-1	802-6, 802-8, 902-6, 902-8	800-0	809-0, 809-1	809-2, 809-3	810-0, 810-1, 810-2, 910-0, 910-2	810-3	803-1, 903-1	
Page	8, 9		20, 21	10	35, 36	36, 37	37, 38	39	23
Diameter	1xD		1xD	1xD	1xD	1xD	1xD	1xD	1xD
1.5mm	0.02-0.07 mm								
1/16"	0.001-0.003"								
3mm	0.05-0.10 mm	0.30-0.45 mm	0.12-0.17 mm					0.07-0.12	
1/8"	0.002-0.004"	0.012-0.018"	0.005-0.007"					0.003-0.005"	
6mm	0.10-0.15 mm	0.35-0.40 mm	0.17-0.22 mm			0.35-0.40 mm		0.12-0.17 mm	
1/4"	0.004-0.006"	0.014-0.016"	0.007-0.009"			0.014-0.016"		0.005-0.007"	
10mm	0.12-0.17 mm	0.40-0.45 mm	0.20-0.25 mm	0.48-0.53 mm	0.48-0.53 mm	0.40-0.45 mm	0.48-0.53 mm	0.15-0.20 mm	
3/8"	0.005-0.007"	0.016-0.018"	0.008-0.010"	0.019-0.021"	0.019-0.021"	0.016-0.018"	0.019-0.021"	0.006-0.008"	
12mm		0.45-0.50 mm	0.22-0.27 mm	0.53-0.58 mm	0.53-0.58 mm	0.45-0.50 mm	0.53-0.58 mm	0.17-0.22 mm	
1/2"		0.018-0.020"	0.009-0.011"	0.021-0.023"	0.021-0.023"	0.018-0.020"	0.021-0.023"	0.007-0.009"	
16mm		0.50-0.55 mm		0.58-0.63 mm		0.50-0.55 mm	0.58-0.63 mm		
5/8"		0.020-0.022"		0.023-0.025"		0.020-0.022"	0.023-0.025"		
20mm		0.55-0.60 mm		0.63-0.68 mm		0.55-0.60 mm	0.63-0.68 mm	0.22-0.27 mm	
3/4"		0.022-0.024"		0.025-0.027"		0.022-0.024"	0.025-0.027"	0.009-0.011"	









# Technical Information - Laminated Chipboard Chip Load Specifications

							
Series	802-6, 802-8, 902-6, 902-8	810-0, 810-1, 810-2, 910-0, 910-2	810-3	818-0, 918-0, 818-1	820-2	821-0, 821-1	
Page	20, 21		38	39	49, 50	54	54, 55
Diameter	1xD		1xD	1xD	1xD	1xD	1xD
1.5mm							
1/16"							
3mm	0.33-0.38 mm						
1/8"	0.013-0.015"						
6mm	0.38-0.43 mm	0.43-0.48 mm					
1/4"	0.015-0.017"	0.017-0.019"					
10mm	0.40-0.45 mm	0.48-0.53 mm	0.55-0.60 mm	0.48-0.53 mm			
3/8"	0.016-0.018"	0.019-0.021"	0.022-0.024"	0.019-0.021"			
12mm	0.45-0.50 mm	0.53-0.58 mm	0.60-0.66 mm	0.53-0.58 mm	0.71-0.76 mm	0.53-0.58 mm	
1/2"	0.018-0.020"	0.021-0.023"	0.024-0.026"	0.021-0.023"	0.028-0.030"	0.021-0.023"	
16mm	0.48-0.53 mm	0.63-0.68 mm	0.66-0.71 mm		0.76-0.81 mm	0.58-0.63 mm	
5/8"	0.019-0.021"	0.025-0.027"	0.026-0.028"		0.030-0.032"	0.023-0.025"	
20mm	0.53-0.58 mm	0.68-0.73 mm	0.71-0.76 mm		0.81-0.86 mm	0.63-0.68 mm	
3/4"	0.021-0.023"	0.027-0.029"	0.028-0.030"		0.032-0.034"	0.025-0.027"	







## SPEED AND FEED FORMULAS:

Depth of Cut:  
 1 x D Use suggested chip load. +2 x D Decrease chip load by 25%. +3 x D Decrease chip load by 50%.  
 Formula:  $RPM = \text{Feed Rate} / (\text{Number of Flutes} \times \text{Chip Load})$  •  $\text{Feed Rate} = RPM \times \text{Number of Flutes} \times \text{Chip Load}$  •  $\text{Chip Load} = \text{Feed rate} / (RPM \times \text{Number of Flutes})$

# Chip Load Specifications

							
803-5	815-0, 815-1, 915-0, 915-1	815-2, 915-2, 815-3, 815-4, 815-5	815-6, 915-6	816-1, 816-2, 916-1, 916-2	818-0, 918-0, 818-1	820-0, 820-2	821-0, 821-1
26	44	45, 46	47	47, 48	49, 50	53, 54	54, 55
1/2xD	1xD	1xD	1xD	1xD	1xD	1xD	1xD
0.02-0.07 mm							
0.001-0.003"							
0.05-0.10 mm	0.35-0.40 mm	0.43-0.48 mm		0.45-0.50 mm	0.48-0.53 mm		
0.002-0.004"	0.014-0.016"	0.017-0.019"		0.018-0.020"	0.019-0.021"		
0.07-0.12	0.40-0.45 mm	0.48-0.53 mm		0.50-0.55 mm	0.53-0.58 mm	0.68-0.73 mm	1.00-1.04 mm
0.003-0.005"	0.016-0.018"	0.019-0.021"		0.020-0.022"	0.021-0.023"	0.027-0.029"	0.039-0.041"
	0.45-0.50 mm	0.53-0.58 mm	0.07-0.12 mm	0.55-0.63 mm		0.73-0.78 mm	1.09-1.14 mm
	0.018-0.020"	0.021-0.023"	0.003-0.005"	0.022-0.025"		0.029-0.031"	0.043-0.045"
0.12-0.17	0.50-0.55 mm	0.58-0.63 mm		0.60-0.66 mm		0.81-0.86 mm	1.19-1.24 mm
0.005-0.007"	0.020-0.022"	0.023-0.025"		0.024-0.026"		0.032-0.034"	0.047-0.049"









## Technical Information - Laminated Plywood Chip Load Specifications

						
Laminated Plywood	802-6, 802-8, 902-6, 902-8	810-0, 810-1, 810-2 910-0, 910-2	810-3	818-0, 918-0, 818-1	820-2	821-0, 821-1
Page	20, 21	37, 38	39	49, 50	54	54, 55
Diameter	1xD	1xD	1xD	1xD	1xD	1xD
1.5mm						
1/16"						
3mm	0.33-0.38 mm					
1/8"	0.013-0.015"					
6mm	0.38-0.43 mm	0.38-0.43 mm				
1/4"	0.015-0.017"	0.015-0.017"				
10mm	0.40-0.45 mm	0.40-0.45 mm	0.48-0.53 mm	0.48-0.53 mm		
3/8"	0.016-0.018"	0.016-0.018"	0.019-0.021"	0.019-0.021"		
12mm	0.45-0.50 mm	0.45-0.50 mm	0.53-0.58 mm	0.53-0.58 mm	0.68-0.73 mm	0.48-0.53 mm
1/2"	0.018-0.020"	0.018-0.020"	0.021-0.023"	0.021-0.023"	0.027-0.029"	0.019-0.021"
16mm	0.48-0.53 mm	0.48-0.53 mm	0.58-0.63 mm		0.76-0.81 mm	0.53-0.58 mm
5/8"	0.019-0.021"	0.019-0.021"	0.023-0.025"		0.030-0.032"	0.021-0.023"
20mm	0.53-0.58 mm	0.53-0.58 mm	0.63-0.68 mm		0.81-0.86 mm	0.58-0.63 mm
3/4"	0.021-0.023"	0.021-0.023"	0.025-0.027"		0.032-0.034"	0.023-0.025"







### SPEED AND FEED FORMULAS:

Depth of Cut:  
 1 x D Use suggested chip load. +2 x D Decrease chip load by 25%. +3 x D Decrease chip load by 50%.  
 Formula:  $RPM = \frac{Feed Rate}{(Number\ of\ Flutes \times Chip\ Load) \cdot Feed\ Rate} = RPM \times Number\ of\ Flutes \times Chip\ Load = Feed\ rate / (RPM \times Number\ of\ Flutes)$

# Technical Information - Soft Plastics Chip Load Specifications

							
	Series	823-0, 823-1, 923-0, 923-1	800-1, 900-1	801-0, 801-1, 901-0, 901-2	803-7, 903-7	804-0, 804-2	811-0
Page	8, 9	10	12	27	28, 29	39	44, 45, 46
Dia.	1xD	1xD	1xD	1xD	1xD	1xD	
1.5mm	0.05-0.10 mm		0.05-0.10 mm				
1/16"	0.002-0.004"		0.02-0.004"				
3mm	0.10-0.15 mm	0.10-0.15 mm	0.10-0.15 mm	0.13-0.17 mm	0.05-0.10 mm	0.02-0.07 mm	
1/8"	0.004-0.006"	0.004-0.006"	0.004-0.006"	0.005-0.007"	0.002-0.004"	0.001-0.003"	
6mm	0.20-0.30 mm	0.20-0.30 mm	0.20-0.30 mm	0.17-0.23 mm	0.10-0.20 mm	0.07-0.12 mm	
1/4"	0.008-0.012"	0.008-0.012"	0.008-0.012"	0.007-0.009"	0.004-0.008"	0.003-0.005"	
10mm	0.20-0.30 mm	0.35-0.46 mm	0.20-0.30 mm	0.23-0.28 mm	0.12-0.17 mm	0.10-0.15 mm	0.10-0.15 mm
3/8"	0.008-0.012"	0.014-0.018"	0.008-0.012"	0.009-0.011"	0.005-0.007"	0.004-0.006"	0.004-0.006"
12mm		0.46-0.56 mm	0.25-0.35 mm	0.28-0.33 mm	0.15-0.20 mm	0.12-0.17 mm	0.15-0.20 mm
1/2"		0.018-0.022"	0.010-0.014"	0.011-0.013"	0.006-0.008"	0.005-0.007"	0.006-0.008"
16mm					0.17-0.22 mm		
5/8"					0.007-0.009"		
20mm							
3/4"							

# Technical Information - Composite Chip Load Specifications

					
	Series	802-1	803-0, 803-1, 903-0, 903-1	817-0, 817-1	819-0, 819-1
Page	18	22, 23	48, 49	51	52
Diameter	1xD	1xD	1xD	1xD	1xD
1.5mm					
1/16"					
3mm	0.07-0.12 mm	0.05-0.10 mm		0.05-0.10 mm	
1/8"	0.003-0.005"	0.002-0.004"		0.002-0.004"	
6mm	0.07-0.12 mm	0.07-0.12 mm		0.05-0.10 mm	
1/4"	0.003-0.005"	0.003-0.005"		0.002-0.004"	
10mm	0.10-0.15 mm	0.10-0.15 mm	0.05-0.25 mm	0.07-0.15 mm	0.17-0.22 mm
3/8"	0.004-0.006"	0.004-0.006"	0.002-0.010"	0.003-0.006"	0.007-0.009"
12mm	0.12-0.0.17 mm	0.12-0.17 mm mm	0.05-0.25 mm	0.18-0.23 mm	0.20-0.25 mm
1/2"	0.005-0.007"	0.005-0.007"	0.002-0.010"	0.007-0.009"	0.008-0.010"
16mm					
5/8"					
20mm					
3/4"					







## SPEED AND FEED FORMULAS:

Depth of Cut:  
 1 x D Use suggested chip load. +2 x D Decrease chip load by 25%. +3 x D Decrease chip load by 50%.  
 Formula: RPM = Feed Rate / (Number of Flutes x Chip Load) • Feed Rate = RPM x Number of Flutes x Chip Load • Chip Load = Feed rate / (RPM x Number of Flutes)

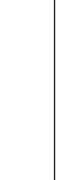
# Technical Information - Hard Plastics Chip Load Specifications

							
	823-0, 823-1, 923-0, 923-1	800-1, 900-1	801-3, 901-3	803-7, 903-7	803-0, 903-0	814-0, 814-1, 914-0, 914-1	815-0 thru 815-6, 915-0 thru 915-6
Page	8, 9	10	14	27	22	42, 43	44, 45, 46
Dia.	1xD	1xD	1xD	1xD			
1.5mm	0.05-0.10 mm		0.05-0.10 mm				
1/16"	0.002-0.004"		0.02-0.004"				
3mm	0.15-0.20 mm	0.08-0.13 mm	0.15-0.20 mm	0.13-0.18 mm			
1/8"	0.006-0.008"	0.003-0.005"	0.006-0.008"	0.005-0.007"			
6mm	0.25-0.30 mm	0.18-0.28 mm	0.25-0.30 mm	0.18-0.23 mm	0.15-0.20 mm	0.10-0.15 mm	
1/4"	0.010-0.012"	0.007-0.011"	0.010-0.012"	0.007-0.009"	0.006-0.008"	0.004-0.006"	
10mm	0.25-0.30 mm	0.33-0.43 mm	0.25-0.30 mm	0.23-0.28 mm	0.18-0.23 mm	0.10-0.15 mm	0.10-0.15 mm
3/8"	0.010-0.012"	0.013-0.017"	0.010-0.012"	0.009-0.011"	0.007-0.009"	.0004-0.006"	0.004-0.006"
12mm		0.43-0.53 mm	0.30-0.40 mm	0.28-0.33 mm	0.20-0.25 mm	0.15-0.25 mm	0.15-0.20 mm
1/2"		0.017-0.021"	0.012-0.016"	0.011-0.013"	0.008-0.010"	0.006-0.010"	0.006-0.008"
16mm							
5/8"							
20mm						0.30-0.40 mm	
3/4"						0.012-0.016"	

# Technical Information - Solid Surface Chip Load Specifications

									
	823-0, 823-1, 923-0, 923-1	801-0, 801-1, 901-2	801-3, 801-4, 901-3, 801-4	800-3, 800-4	804-0, 904-0	805-0, 805-1, 905-0, 905-1	803-0, 803-1, 903-0, 903-1	803-5	814-0, 814-1, 914-0, 914-1
Page	8, 9	12	14, 15	11	28	31, 32	22, 23	26	42, 43
Diameter	1xD	1xD	1xD	1xD	1xD	1xD	1xD	1xD	
1.5mm	0.05-0.10 mm	0.05-0.07 mm	0.05-0.07 mm						
1/16"	0.002-0.004"	0.002-0.003"	0.002-0.003"						
3mm	0.15-0.20 mm	0.05-0.10 mm	0.05-0.10 mm		0.05-0.10 mm	0.08-0.15 mm	0.05-0.10 mm		
1/8"	0.006-0.008"	0.002-0.004"	0.002-0.004"		0.002-0.004"	0.003-0.006"	0.002-0.004"		
6mm	0.25-0.30 mm	0.15-0.25 mm	0.15-0.25 mm	0.05-0.10 mm	0.07-0.12 mm	0.10-0.15 mm	0.07-0.12 mm	0.07-0.15 mm	0.05-0.10 mm
1/4"	0.010-0.012"	0.006-0.010"	0.006-0.010"	0.002-0.004"	0.003-0.005"	0.004-0.006"	0.003-0.005"	0.003-0.006"	0.002-0.004"
10mm	0.25-0.30 mm	0.15-0.25 mm	0.15-0.25 mm		0.10-0.15 mm	0.20-0.25 mm	0.10-0.15 mm	0.07-0.15 mm	0.05-0.15 mm
3/8"	0.010-0.012"	0.006-0.010"	0.006-0.010"		0.004-0.006"	0.008-0.010"	0.004-0.006"	0.003-0.006"	0.002-0.006"
12mm					0.12-0.17 mm	0.30-0.35 mm	0.12-0.17 mm		0.05-0.15 mm
1/2"					0.005-0.007"	0.012-0.014"	0.005-0.007"		0.002-0.006"
16mm					0.15-0.20 mm				0.10-0.20 mm
5/8"					0.006-0.008"				0.004-0.008"
20mm					0.17-0.22 mm				
3/4"					0.007-0.009"				





## SPEED AND FEED FORMULAS:

Depth of Cut:

1 x D Use suggested chip load. +2 x D Decrease chip load by 25%. +3 x D Decrease chip load by 50%.

Formula: RPM = Feed Rate / (Number of Flutes x Chip Load) • Feed Rate = RPM x Number of Flutes x Chip Load • Chip Load = Feed rate / (RPM x Number of Flutes)

# Technical Information - Aluminum Chip Load Specifications

 <b>Aluminum</b>			
<b>Series</b>	<b>823-0, 823-1, 923-0, 923-1</b>	<b>802-1, 902-1</b>	<b>805-0, 905-0</b>
<b>Page</b>	<b>8, 9</b>	<b>18</b>	<b>31</b>
<b>Diameter</b>	<b>1xD</b>	<b>1xD</b>	<b>1xD</b>
1.5mm	0.05-0.10		
1/16"	0.002-0.004"		
3mm	0.05-0.10	0.15-0.20	0.07-0.12
1/8"	0.002-0.004"	0.006-0.008"	0.003-0.005"
6mm	0.07-0.15	0.17-0.22	0.10-0.15
1/4"	0.003-0.006"	0.007-0.009"	0.004-0.006"
10mm	0.10-0.20	0.20-0.25	0.15-0.20
3/8"	0.004-0.008"	0.008-0.010"	0.006-0.008"
12mm	0.12-0.22	0.22-0.27	0.25-0.30
1/2"	0.005-0.009"	0.009-0.011"	0.010-0.012"
16mm			
5/8"			
20mm			
3/4"			

## SPEED AND FEED FORMULAS:

Depth of Cut:  
 1 x D Use suggested chip load. • 2 x D Decrease chip load by 25%. • 3 x D Decrease chip load by 50%.  
 Formula:  $RPM = \text{Feed Rate} / (\text{Number of Flutes} \times \text{Chip Load})$  •  $\text{Feed Rate} = RPM \times \text{Number of Flutes} \times \text{Chip Load}$  •  $\text{Chip Load} = \text{Feed rate} / (RPM \times \text{Number of Flutes})$



# Coatings



## **PowerT (Titanium Nitride, TiN) (append -2)\***

Color: Gold  
Vickers Hardness: approximately 2,300 Vickers  
General purpose, entry level over uncoated carbide



## **PowerC (Titanium Carbon Nitride, TiCN) (append -3)\***

Color: ranges from slight violet to brown-gray  
Vickers Hardness: approximately 3,000 Vickers  
Used on ferrous, non-ferrous and non-magnetic stainless steel  
Good abrasion resistance, low heat resistance, for applications requiring low RPMs and high thrust



## **PowerA (Aluminum Titanium Nitride, AlTiN) (append -1)\***

Color: Dark Gray  
Vickers Hardness: approximately 3,600 Vickers  
Nickel Alloys, Stainless Steel, Hardened Steels, Tool Steels, Cast Iron  
An excellent broad spectrum grade. May be run in dry or minimum quantity lubrication applications, where heat can be a problem. Also handles light chip loads very well



## **PowerZ (Zirconium Nitride, ZrN) (append -4)\***

Color: dull Gold  
Vickers Hardness: approximately 2,800 Vickers  
Outstanding on aluminum, including high silica aluminum. Can also be used on cast iron, stainless steels, titanium

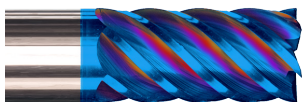

## **PowerN (nACo) nano-composite (nc-AlTiN)/(a-Si<sup>3</sup>N<sup>4</sup>) (append -5)\***

Color: varying shades of blue-gray; blue-based color dissipates immediately upon use.  
Vickers Hardness: approximately 4,500 Vickers  
Outstanding performance in superalloys, hard material machining, high heat applications and best when used with very rigid setup.



## **PowerNR (nACRo) nano-composite (nc-AlCrN/a-Si<sup>3</sup>N<sup>4</sup>)(append -8)\***

Color: gray  
Vickers Hardness: 4,000 Vickers  
Outstanding in high heat applications, better resistance to shock and chipping than nACo, for tough, aggressive cutting applications.



## **PowerDLC (Diamond Like Carbon)(append -6)\***

Color: variable gray to black  
Vickers Hardness: approximately 4,000 Vickers  
Non-ferrous metals, high silicone aluminum, copper, plastic, graphite, fiberglass or reinforced plastics  
Can be applied to any carbide substrate



# Terms and Conditions

## To Order

Faxed or e-mailed orders are required. Please specify quantity and EDP/Part numbers.

Minimum Orders: \$50 for standard items, \$200 for special orders. Orders below \$50 are subject to a \$7.50 handling fee.

## Mastercut Tool Corp.

### Main Office

965 Harbor Lake Dr.  
Safety Harbor, FL 34695 USA  
Tel: (727) 726-5336  
Fax: (727) 725-2532  
Email: sales@mastercuttool.com

### European Office

Heliumstraat 8  
763PL Rijssen  
Netherlands  
Tel: +31 (0) 404 002839  
Email: sales@mastercuttool.com

## Standard Payment Terms

Overseas customers: Prepaid.

US customers: Net 30 Days, pending credit approval, past due after 30 days from billing date.

## Freight

Freight is F.O.B. Origin. International orders are shipped under the Incoterm ExWorks. Mastercut Tool Corp. offers daily service with FedEx and UPS. Shipments made Pre-Pay & Add on Mastercut's FedEx or UPS accounts are subject to a \$2.50 handling fee for domestic shipments and a \$25.00 handling fee for international shipments. We are also happy to utilize any freight carrier when shipping on a collect or third-party account, with no additional handling fee.

## Return Policy

Standard items that Mastercut maintains in stock may be returned with a 25% restocking fee.

All returns must be received within 2 months of original ship date. We are unable to accept returns on non-stock items or specials.

## Special Tooling

When you need a non-standard tool for a specific job, give us a call. Requirements for special tooling or modifications of existing standard items will be given prompt, expert attention.

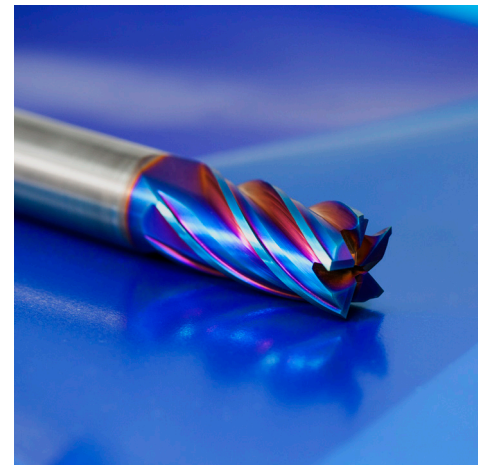
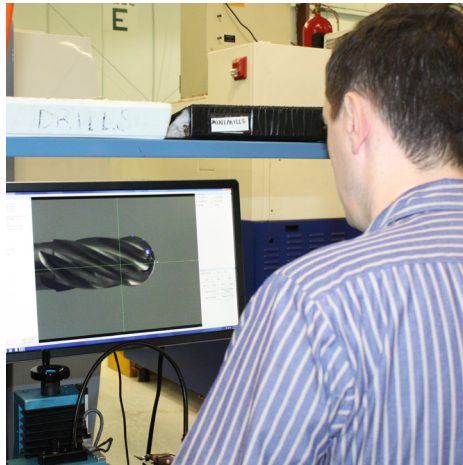
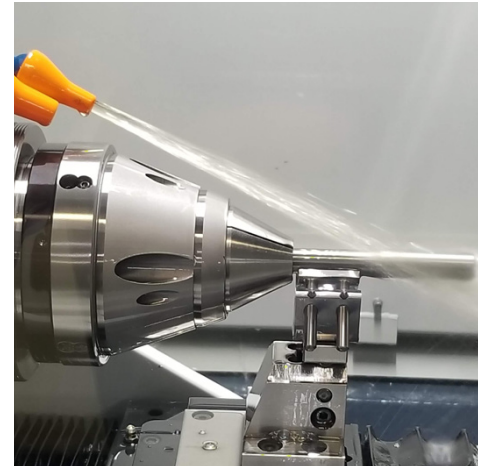
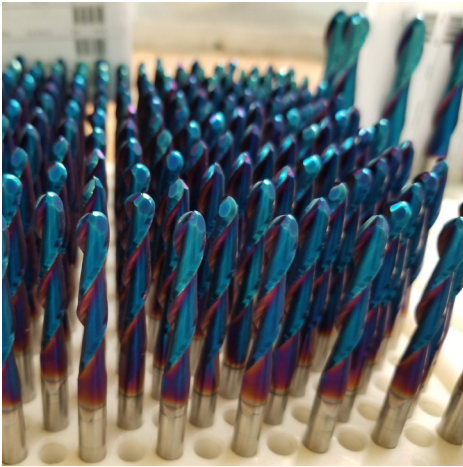
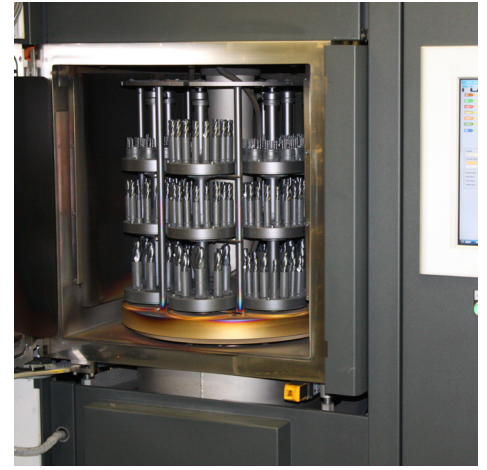
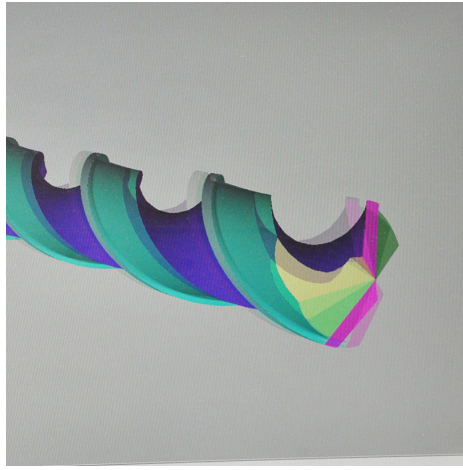
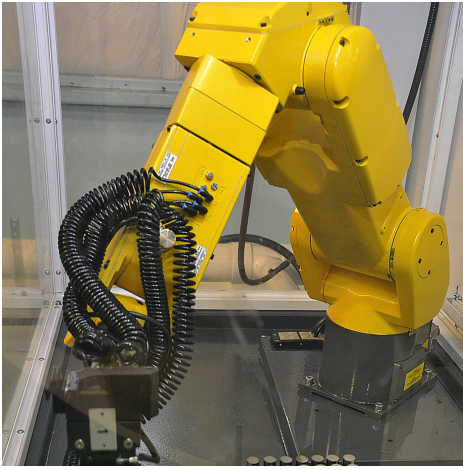

**Mastercut Tool Corp. - Corporate Headquarters**  
 965 Harbor Lake Dr.  
 Safety Harbor, Florida 34695 USA  
 Tel: (727) 726-5336  
 Fax: (727) 725-2532

**Mastercut Tool Corp. - European Warehouse**  
 Heliumstraat 8  
 7463PL Rijssen  
 Netherlands  
 Tel: +31 404 002839

**Email: [sales@mastercuttool.com](mailto:sales@mastercuttool.com)**  
**Web: [www.mastercuttool.com](http://www.mastercuttool.com)**

**Additional US Warehouses**  
**located in California, Michigan and Texas**

# Metal Working Tools included in our Rotary Cutting Tools Catalog



## SOLID CARBIDE ENDMILLS



## HIGH PERFORMANCE ENDMILLS

## PRO+ PERFORMANCE



## ROUTERS FOR WOOD, PLASTIC, AND FIBERGLASS

## DRILLS, COUNTERSINKS

## REAMERS



## CARBIDE BURS - SOLID AND BRAZED SHANK



**Mastercut Tool Corp. - Corporate Headquarters**  
 965 Harbor Lake Dr.  
 Safety Harbor, Florida 34695 USA  
 Tel: (727) 726-5336  
 Fax: (727) 725-2532

**Mastercut Tool Corp. - European Warehouse**  
 Heliumstraat 8  
 7463PL Rijssen  
 Netherlands  
 Tel: +31 404 002839

Email: [sales@mastercuttool.com](mailto:sales@mastercuttool.com)  
 Web: [www.mastercuttool.com](http://www.mastercuttool.com)



**Proudly Distributed By:**

